

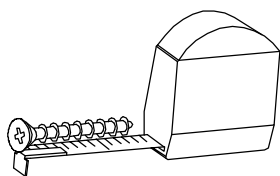

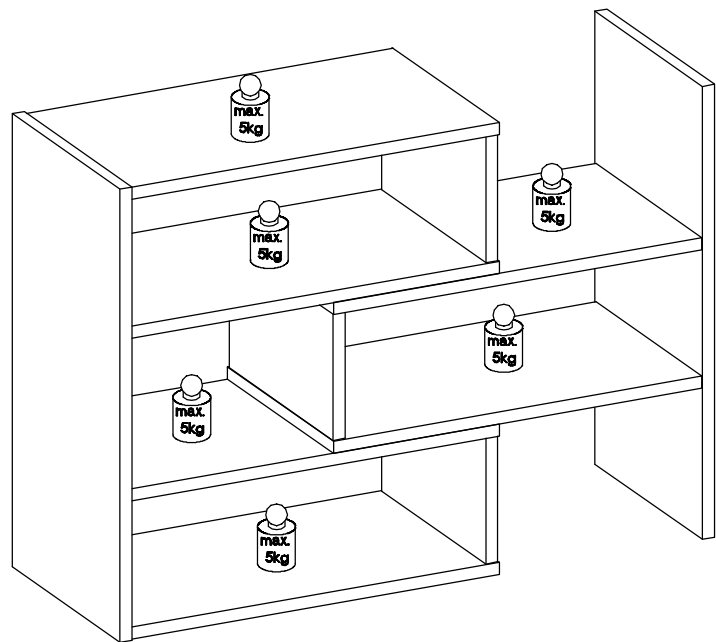

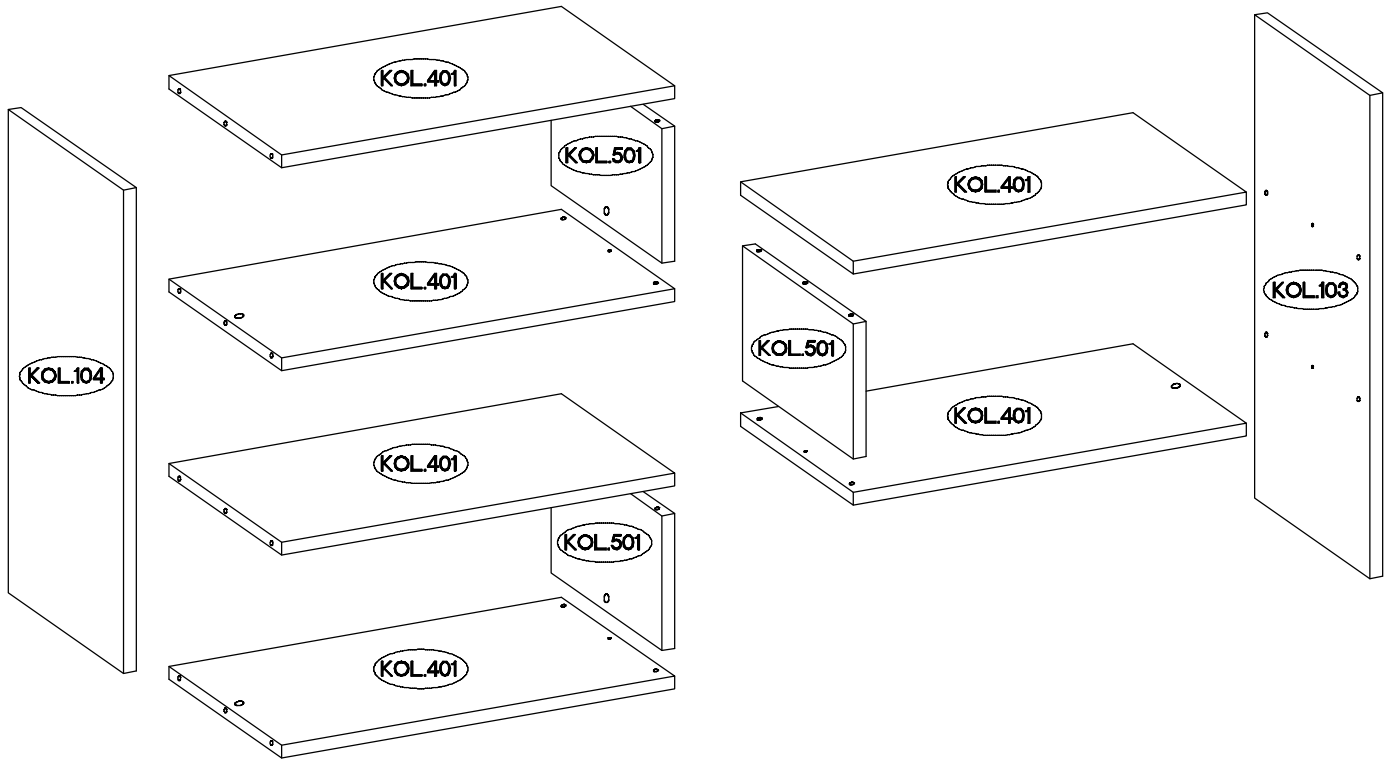

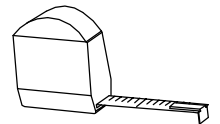

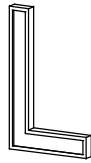
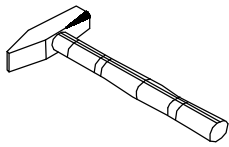
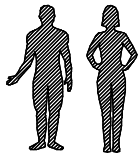

Regał KAROL 3



 #8x30mm A 24	 L=20mm D2 12	 #15/12mm C 12	 #15x5mm F4 6	 E 12	 0,05 O11 1
--	---	--	---	--	---

1.

 $\varnothing 8 \times 30 \text{ mm}$	 L=20mm	 $\varnothing 15/12 \text{ mm}$	 0,05
A	D2	C	O11
24	12	12	1

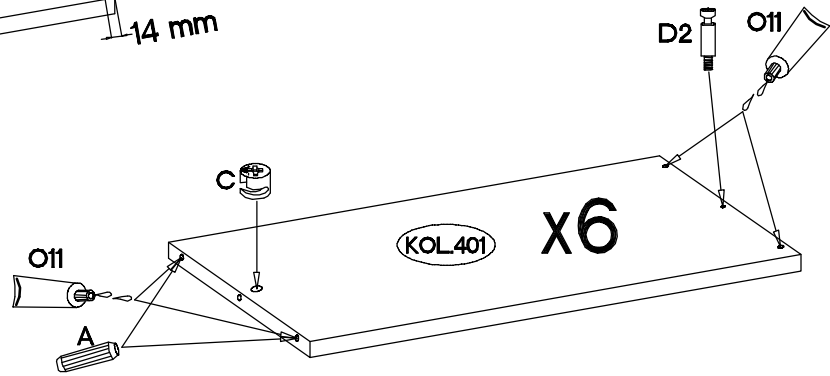
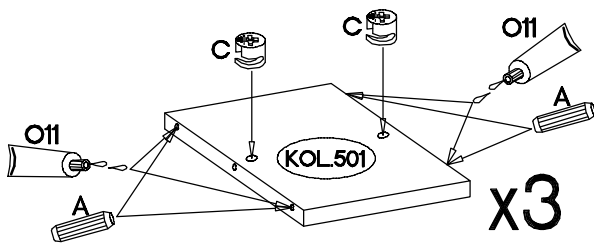
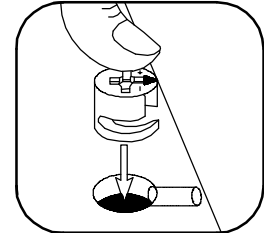
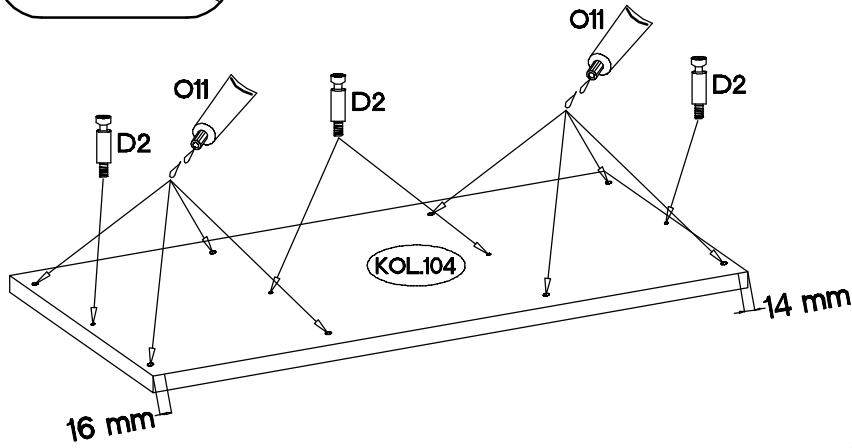
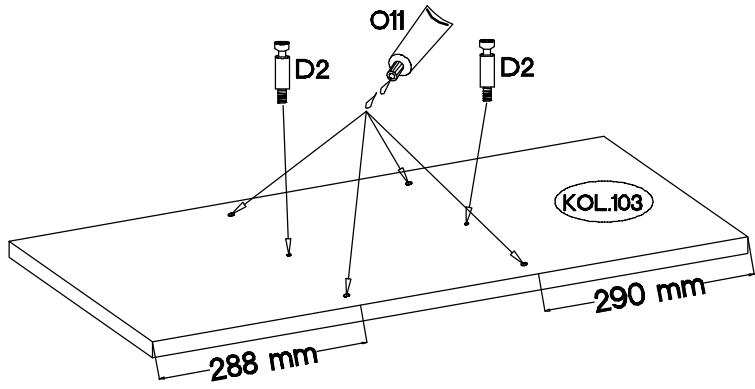
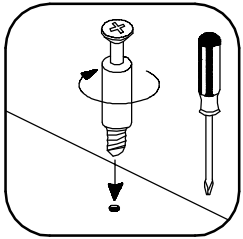

2.

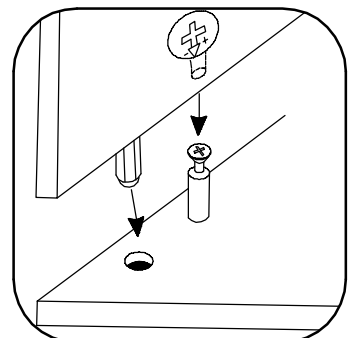
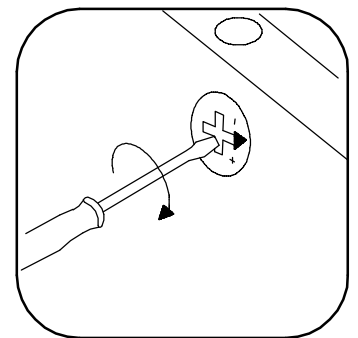
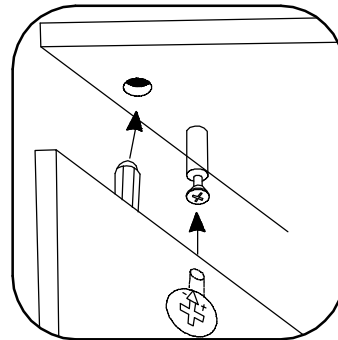
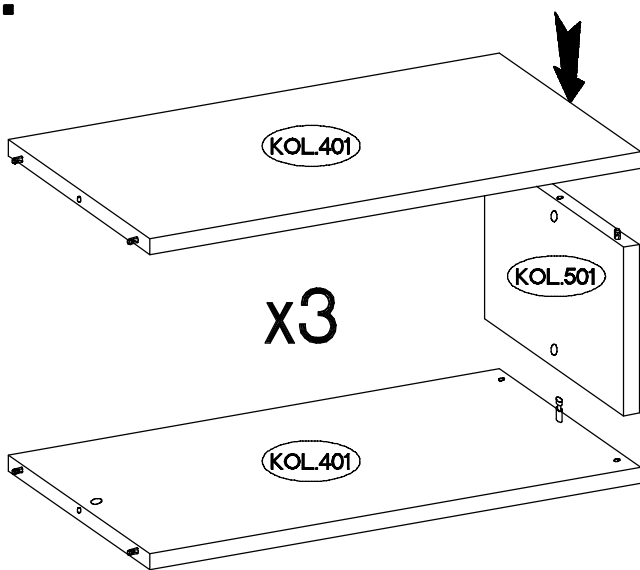

3.

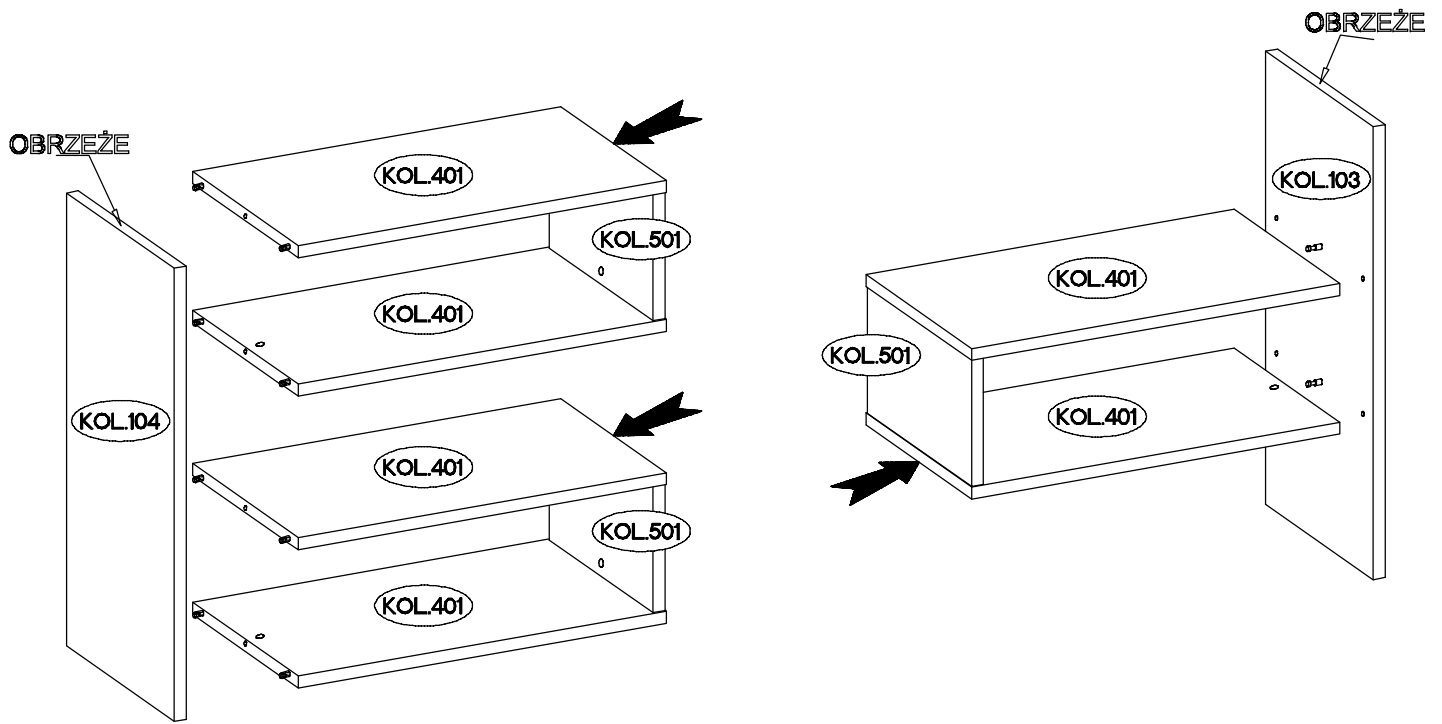

4.

