

60 D 3S BB Premium Box

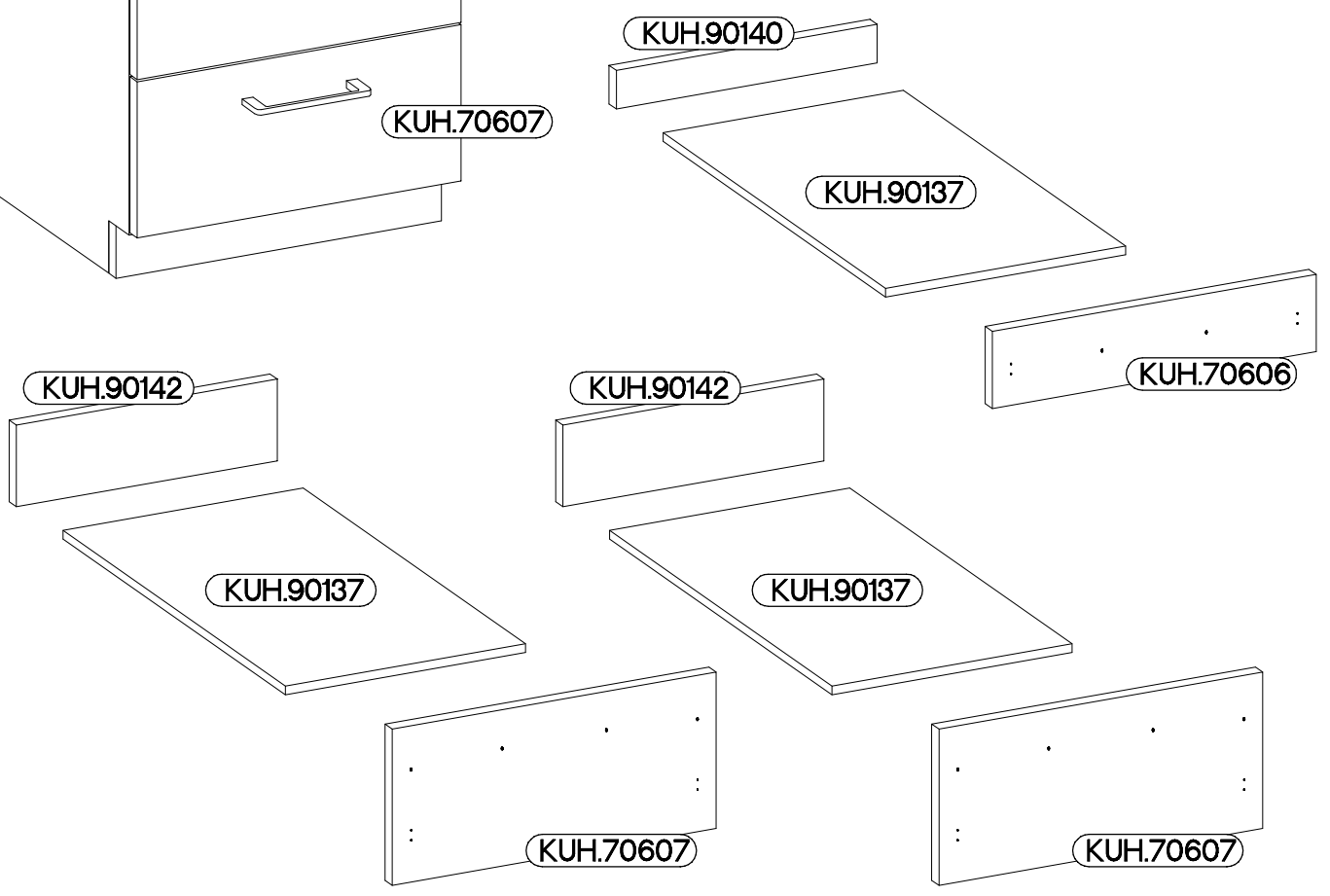

11A	11B	11C	11D	11E	11F
3	2	3	1	6	4
11G	11H	M3	P1	P5	R2
6	4	12	24	24	6
					S15
					3

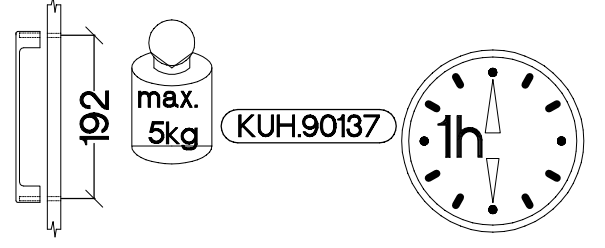
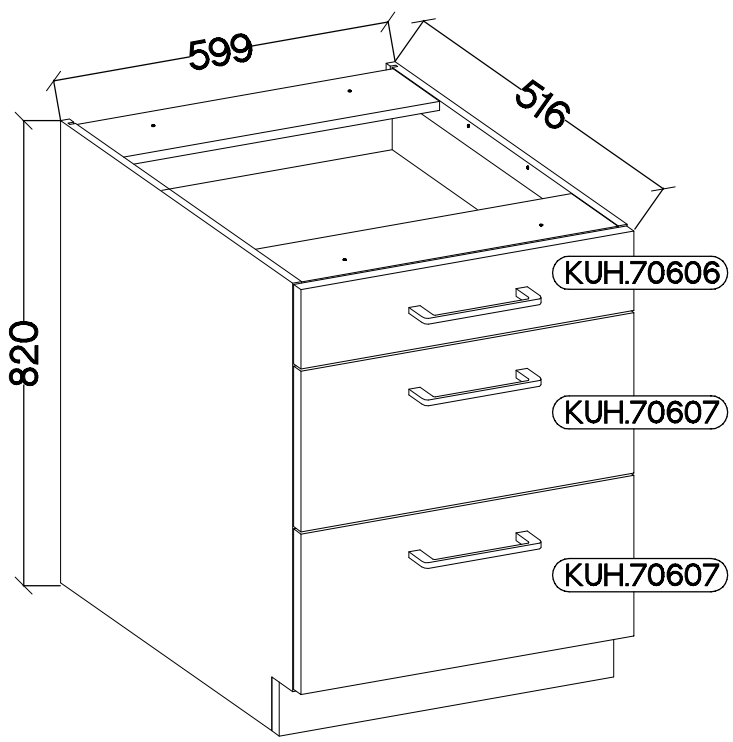
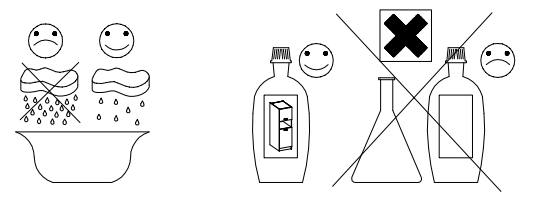
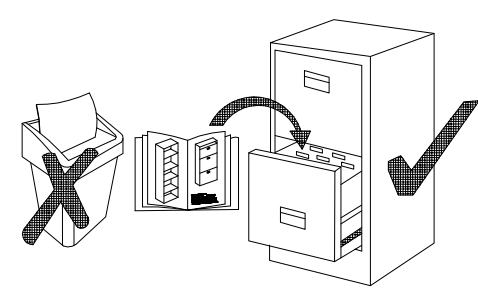

1

					$\pm 4.0 \times 16 \text{mm}$ 	$\pm 3.5 \times 13 \text{mm}$ 	
2	2	4	4	4	8	16	4

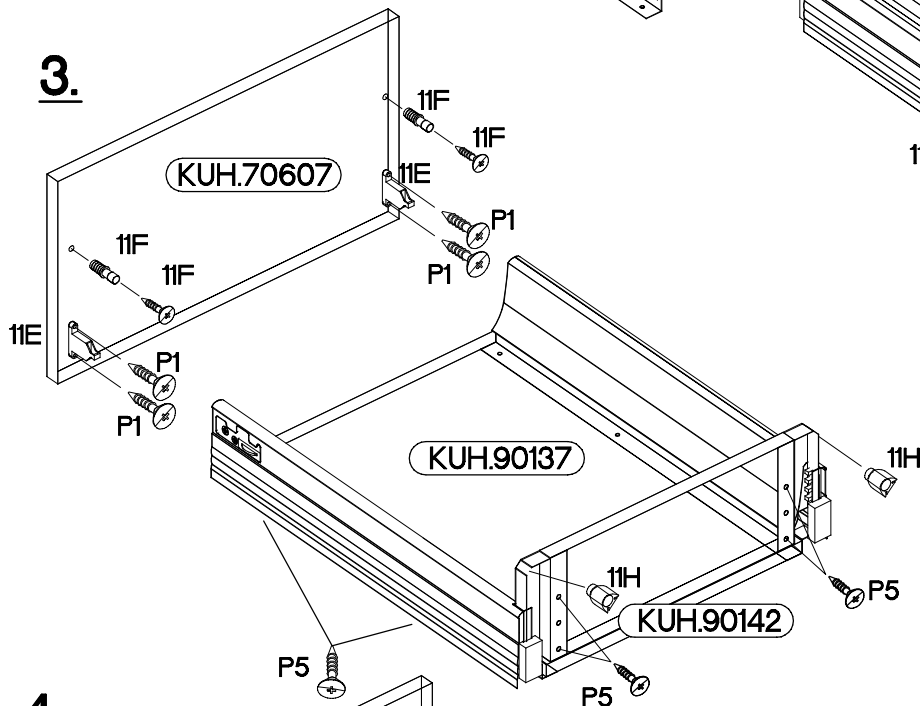
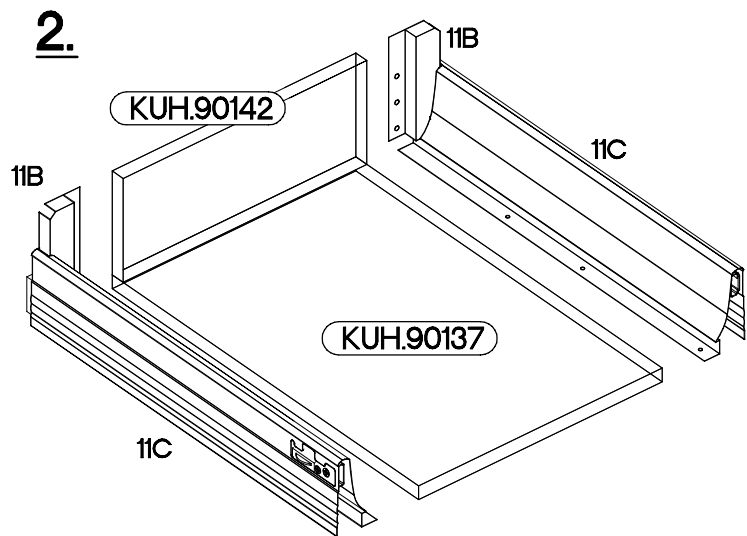
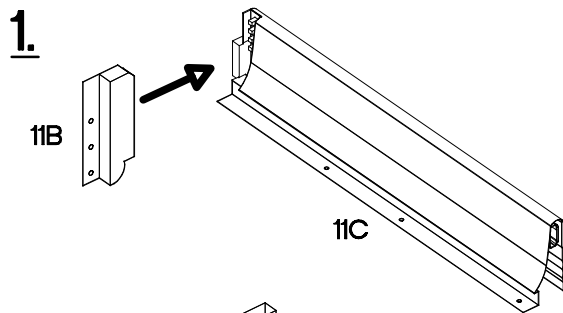

x2

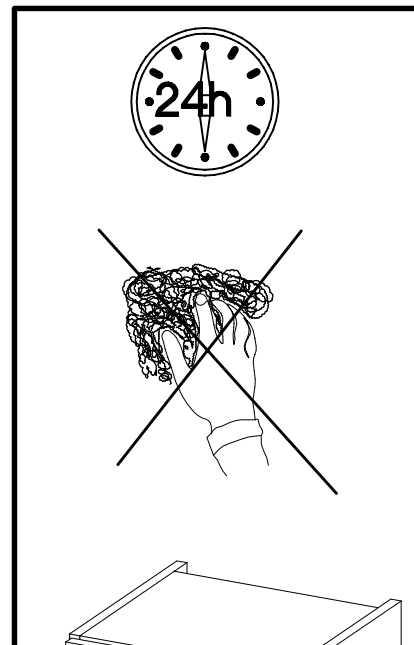
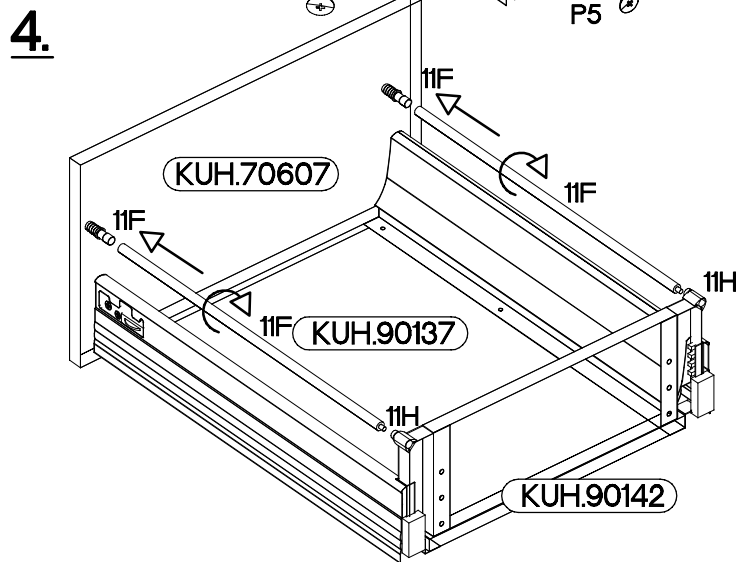

VARIANT HIGH GLOSS

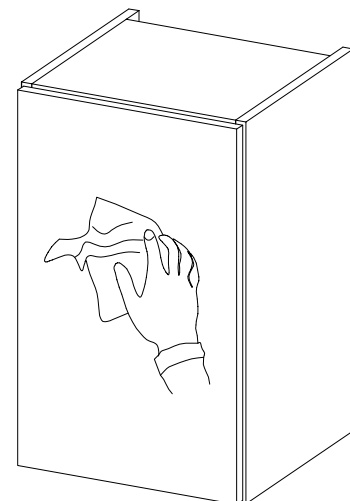
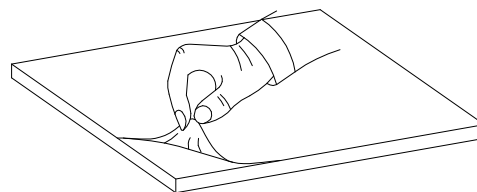
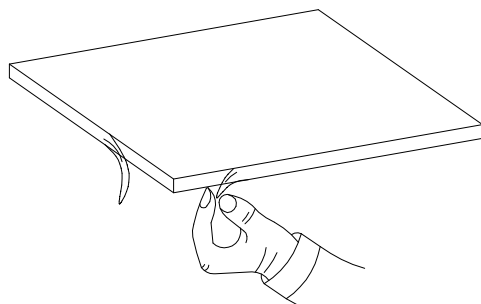

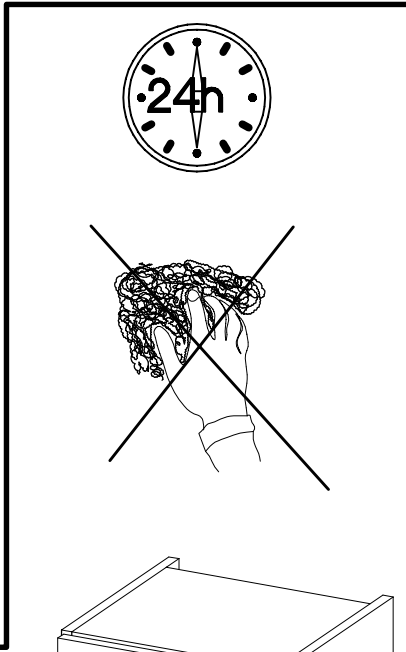
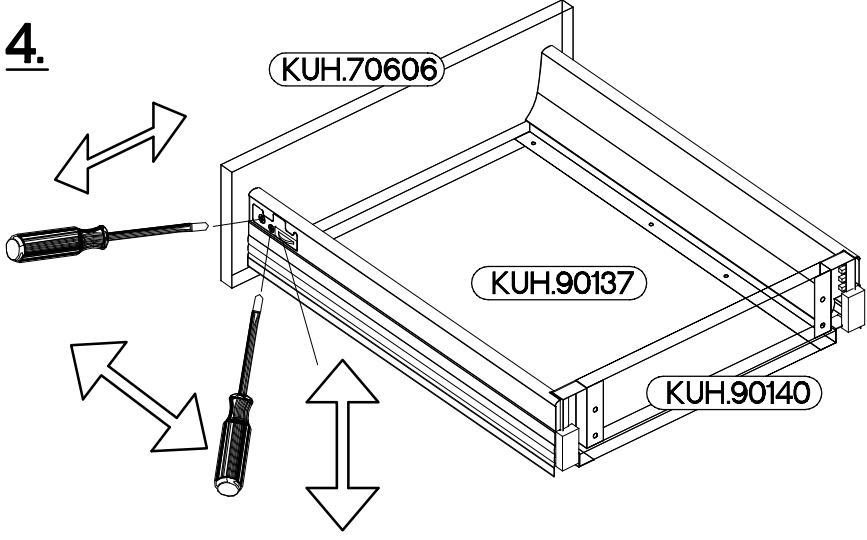
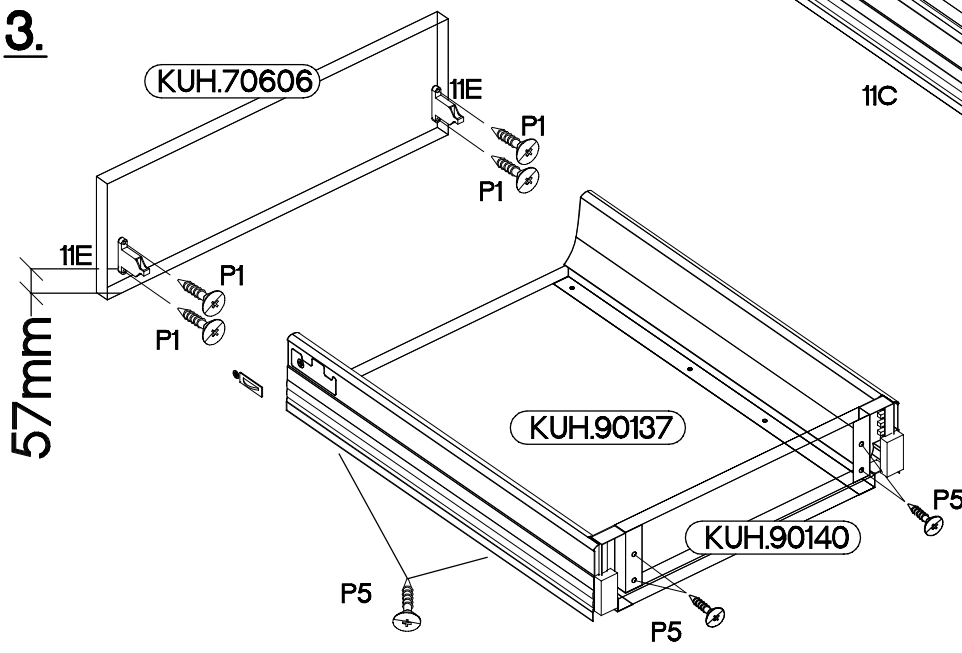
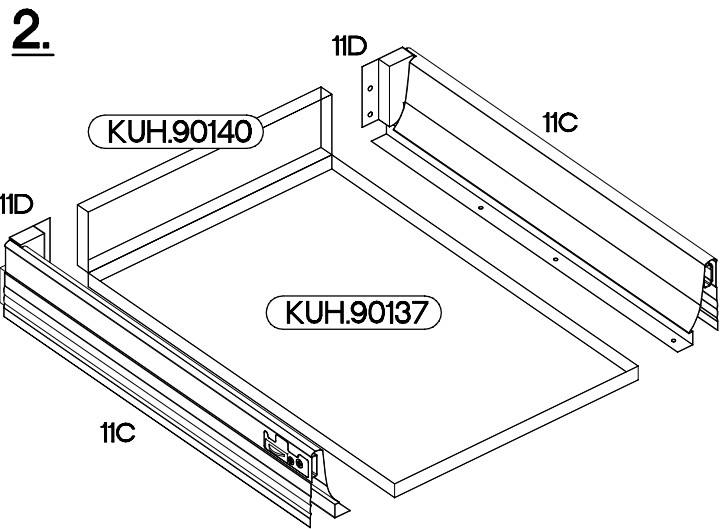
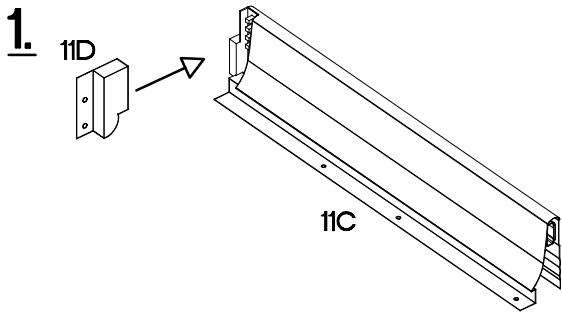

11D	11C	11E	P1	P5	11G
1	1	2	4	8	2

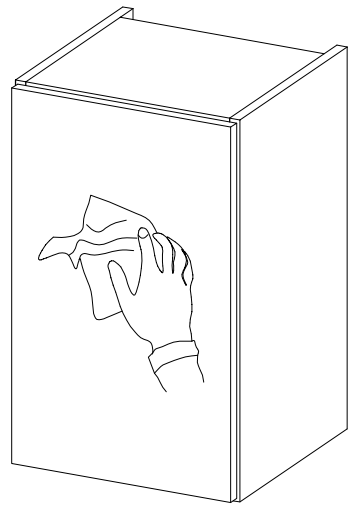
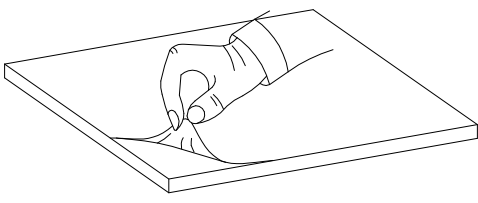
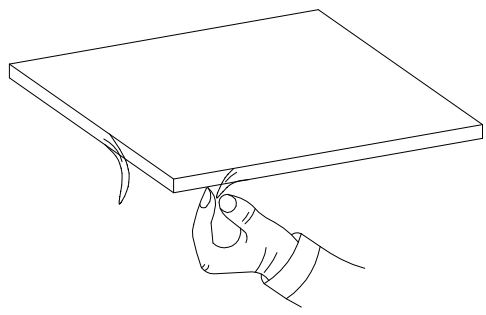

VARIANT HIGH GLOSS

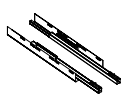

3

		
11A	M3	P1
3	12	12

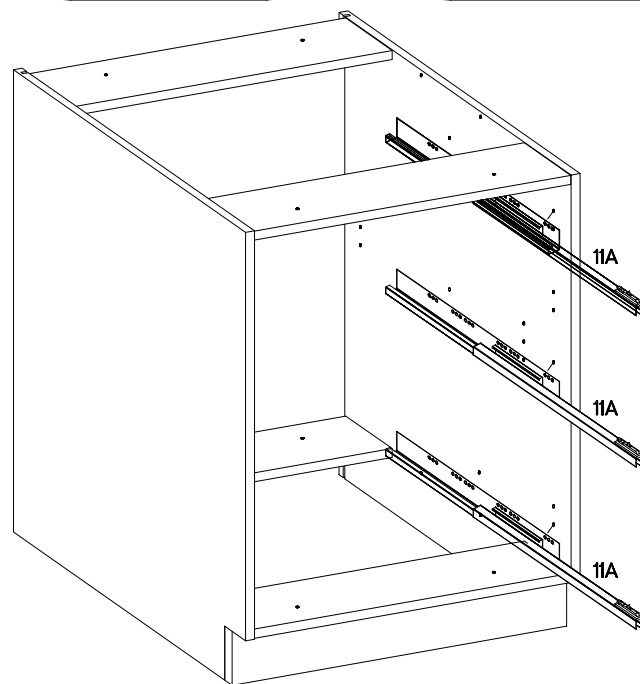
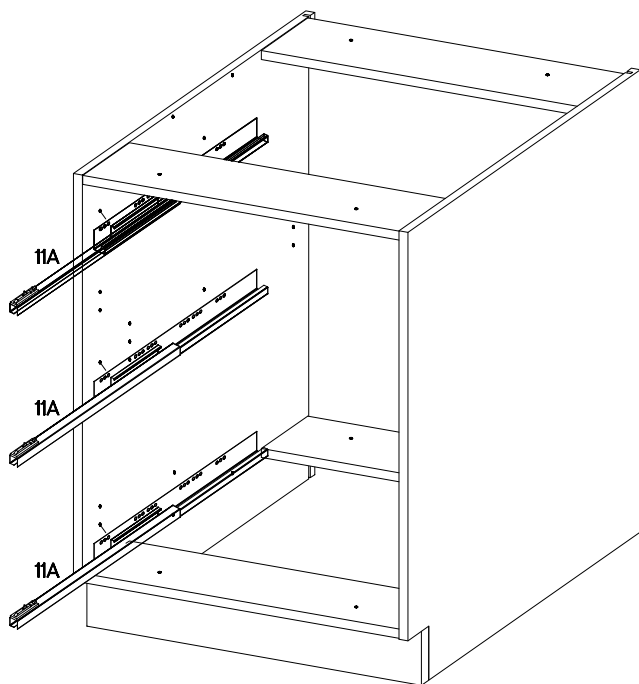
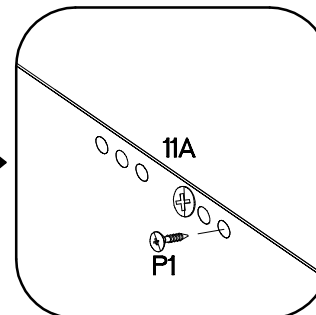
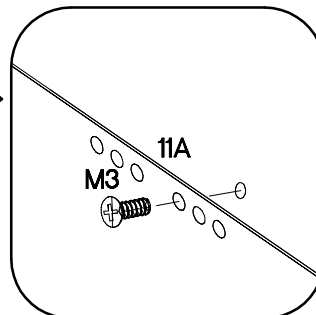
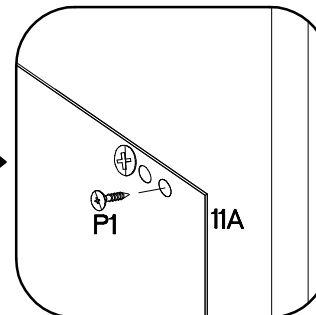
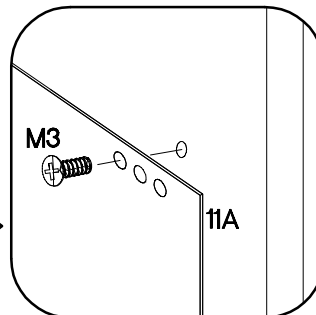
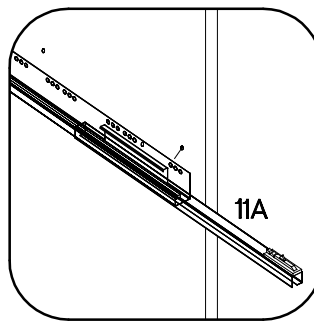

4

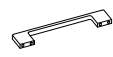
	
R2	S15
6	3

