

- PL Instrukcja montażu
- D Montageanleitung
- NL Handleiding voor de montage
- TR Montaj talimatı
- F Notice de montage
- CZ Montážní návod
- HU Szerelési útmutató
- GB Assembly instructions
- RU Инструкция по монтажу
- IT Istruzioni di montaggio
- SK Návod na montáž
- RO Instrucțiuni de montaj
- ES Instrucciones de montaje

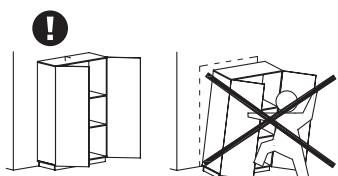

2024-02-26

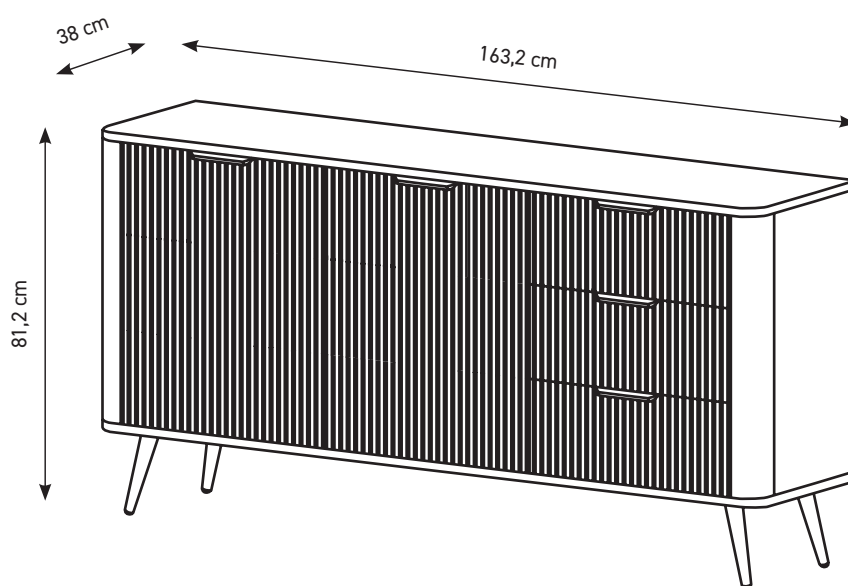

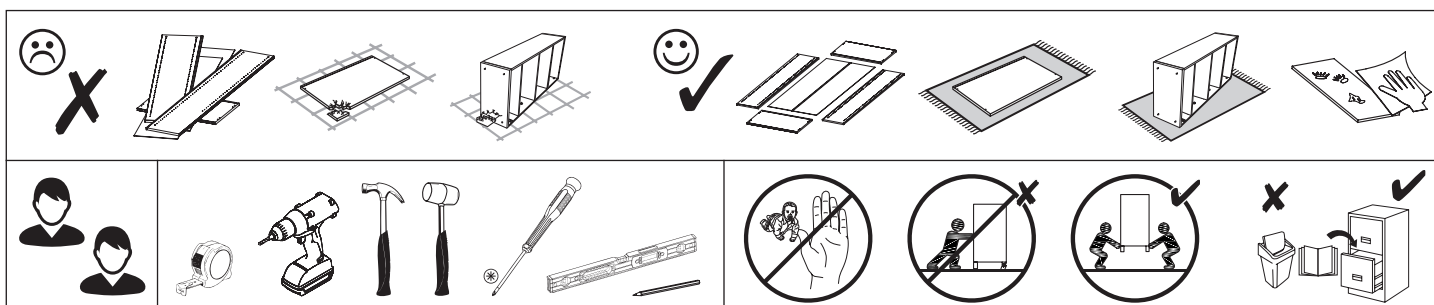
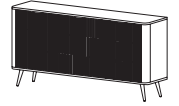

**PL** Przed rozpoczęciem montażu mebla wszystkie elementy należy sprawdzić czy nie są uszkodzone. W przypadku wykrycia uszkodzenia elementu należy odstąpić od montażu mebla i złożyć reklamację. Montaż produktu w oparciu o uszkodzone elementy oznacza akceptację ich stanu przez Kupującego, co powoduje, że reklamacja uszkodzonych elementów nie będzie uznawana.

Nie wolno przekraczać podanych maksymalnych wartości obciążenia. W innym przypadku można mebel uszkodzić lub zniszczyć.

Przed zawieszeniem mebla, lub przymocowaniem go do ściany (w celu zabezpieczenia przed przewróceniem), sprawdź wcześniej rodzaj i wytrzymałość ściany. Dobierz odpowiednie kotki i wkręty do rodzaju ściany. W przypadku wątpliwości skontaktuj się ze specjalistą. Montaż musi zostać wykonany przez osobę kompetentną.

**D** Vor Beginn der Möbelmontage sollten alle Elemente auf Beschädigungen überprüft werden. Wenn ein Element des Produkts beschädigt ist, installieren Sie das Produkt bitte nicht und reichen Sie eine Beschwerde ein. Die Installation des Produkts auf der Grundlage der beschädigten Elemente bedeutet, dass der Käufer seinen Zustand akzeptiert, was bedeutet, dass die Beschwerde über beschädigte Elemente nicht akzeptiert wird.

Überschreiten Sie die angegebenen Maximalbelastungen nicht. Andernfalls kann das Möbelstück beschädigt oder zerstört werden.

Bevor Sie ein Möbelstück an einer Wand aufhängen oder befestigen (um es gegen Umkippen zu sichern), prüfen Sie Art und Tragfähigkeit der Wand. Wählen Sie für die Wand geeigneten Dübel und Schrauben. Im Zweifelsfall kontaktieren Sie bitte einen Fachmann. Die Montage muss durch eine sachkundige Person ausgeführt werden.

**F** Avant de commencer l'assemblage du meuble, tous les éléments doivent être vérifiés pour détecter tout dommage. Si un élément du produit est endommagé, veuillez ne pas installer le produit et déposer une plainte. L'installation du produit sur la base des éléments endommagés signifie que l'Acheteur accepte leur état, ce qui signifie que la réclamation d'éléments endommagés ne sera pas acceptée.

Ne dépassez pas les charges maximum indiquées. Sinon, le meuble peut être endommagé ou détruit.

Avant de suspendre le meuble ou de le fixer au mur (dans le but d'éviter un renversement), vérifiez au préalable le type et la résistance du mur. Utilisez les chevilles et les vis adaptées au type de mur. En cas de doute, veuillez contacter un spécialiste. Le montage doit être réalisé par une personne compétente.

**CZ** Před zahájením montáže nábytku je třeba zkontrolovat poškození všech prvků. Pokud je některý prvek produktu poškozen, zdržte se instalace produktu a podejte stížnost. Instalace výrobku na základě poškozených prvků znamená, že kupující akceptuje jejich stav, což znamená, že reklamacje poškozených prvků nebude uznána. Nepřekračujte uvedené maximální zatížení. V opačném případě může dojít k poškození nebo zničení nábytku.

Před zavěšením nábytku nebo jeho připevněním ke zdi (za účelem zajištění před převrácením) dříve zkontrolujte druh a odolnost stěny. Vyberte k druhu stěny vhodné hmoždinky a šrouby. V případě pochybností kontaktujte specialistu. Montáž musí být provedena kompetentní osobou.

**HU** A bútorszerelés megkezdése előtt ellenőrizni kell az összes elem sérülését. Ha a termék bármely eleme megsérült, kérjük, tartózkodjon a termék telepítésétől és nyújtson be panaszt. A termék sérült elemek alapján történő felszerelése azt jelenti, hogy a Vevő elfogadja azok állapotát, ami azt jelenti, hogy a sérült elemek igényét nem fogadják el. A megadott maximális terhelési értékeket nem szabad túllépni. Ellenkező esetben a bútor megsérülhet vagy megsemmisülhet.

A bútor felfüggesztése illetve falhoz való rögzítése (megakadályozván ezzel eldőléseinek lehetőségét) előtt ellenőrizze a fal fajtáját és szilárdságát. Megfelelő, a falhoz illő tipliket és csavarokat használjon. Ha kétsége támadna, konzultáljon szakemberrel. A felszerelést csakis egy hozzáértő szakember végezheti el.

**GB** Before starting the furniture assembly, all elements should be checked for damage. If any element of the product is damaged, please refrain from installing the product and file a complaint. Installation of the product on the basis of the damaged elements means the Buyer's acceptance of their condition, which means that the complaint of damaged elements will not be accepted.

The specified maximum load values must not be exceeded. Otherwise, the piece of furniture may be damaged or destroyed.

Before suspending or fixing furniture to the wall (in order to prevent falling over), check the type and strength of the wall. Select wall plugs and screws appropriate for the given type of the wall. In the case of doubts, contact a specialist. The installation must be performed by a competent person.

**SK** Pred začatím montáže nábytku by sa mali skontrolovať všetky prvky, či nie sú poškodené. Ak je niektorý prvok výrobku poškodený, neinštalujte výrobok a reklamujte ho. Inštalácia produktu na základe poškodených prvkov znamená, že Kupujúci akceptuje ich stav, čo znamená, že reklamácia poškodených prvkov nebude akceptovaná. Uvedené hodnoty maximálneho zaťaženia nesmú byť prekročené. V opačnom prípade môže dôjsť k poškodeniu alebo zničeniu nábytku.

Pred zaviesním nábytku alebo jeho pripewnením na stenu (za účelom zaistenia pred prevrátením) predtým skontrolujte druh a odolnosť steny. Vyberte k druhu steny vhodné hmoždinky a skrutky. V prípade pochybností kontaktujte špecialistu. Montáž musí byť vykonaná kompetentnou osobou.

**RU** Перед началом сборки мебели следует проверить все элементы на предмет повреждений. Если какой-либо элемент продукта поврежден, пожалуйста, воздержитесь от установки продукта и подайте жалобу. Установка товара на поврежденные элементы означает, что Покупатель принимает их состояние, а значит, претензии по поврежденным элементам не принимаются.

Указанные максимальные значения нагрузки не должны превышаться. В противном случае предмет мебели может быть поврежден или уничтожен.

Перед подвешиванием мебели или ее креплением к стене (для защиты от падений) проверьте предварительно тип и прочность стены. Подберите соответствующие типу стены дюбели и шурупы. При возникновении сомнений свяжитесь со специалистом. Монтаж должен проводиться компетентным лицом.

**IT** Prima di iniziare l'assemblaggio del mobile, tutti gli elementi dovrebbero essere controllati per danni. Se qualche elemento del prodotto è danneggiato, astenersi dall'installare il prodotto e presentare un reclamo. L'installazione del prodotto sulla base degli elementi danneggiati implica l'accettazione da parte dell'Acquirente della loro condizione, il che significa che il reclamo per elementi danneggiati non sarà accettato.

I valori di carico massimo specificati non devono essere superati. In caso contrario, il mobile potrebbe essere danneggiato o distrutto.

Prima di appendere i mobili, oppure attaccarli al muro (per proteggerli da ribaltamenti), verifica prima la tipologia e resistenza del muro. Scegli i tasselli e viti più adatti per il tipo di muro. In caso di dubbi contattare uno specialista. Il montaggio deve essere fatto da una persona competente.

**NL** Voordat u met de meubelmontage begint, moeten alle elementen op schade worden gecontroleerd. Als een onderdeel van het product beschadigd is, installeer het dan niet en dien een klacht in. Installatie van het product op basis van de beschadigde elementen betekent dat de koper hun staat accepteert, wat betekent dat de claim voor beschadigde elementen niet wordt geaccepteerd.

Overschrijd de aangegeven maximale belastingen niet. Anders kan het meubelstuk worden beschadigd of vernield.

Voordat u het meubel ophangt of bevestigt tegen de muur (om het te beschermen tegen omvallen) dient u het type en de duurzaamheid van deze muur na te kijken. Maak gebruik van pluggen en schroeven die geschikt zijn voor het type muur. Neem in geval van twijfels contact op met een specialist. De assemblage dient te worden uitgevoerd door iemand met kennis van zaken.

**TR** Mobilya montajına başlamadan önce tüm elemanlarda hasar olup olmadığını kontrol edilmelidir. Ürünün herhangi bir parçası hasar görmüşse, lütfen ürünü kurmayın ve şikayete bulunun. Ürünün hasarlı elemanlar bazında montajı, Alıcının durumunu kabul ettiği anlamına gelir, bu da hasarlı elemanlar için talep kabul edilmeceği anlamına gelir.

Belirtilen azami yük değerini aşmayınız, aksi takdirde mobilya parçaları zarar görebilir veya kullanılamaz hale gelebilir.

Mobilyayı duvara asmadan veya montaj etmeden önce (devrilmesini önlemek için) duvarın türünü ve dayanıklılığını kontrol edin. Duvara uygun dübelleri ve vidaları seçin. Emin olamamanız durumunda bir uzman ile irtibata geçin. Kurulum yetkili bir kişi tarafından yapılmalıdır.

**RO** Înainte de a începe asamblarea mobilierului, toate elementele trebuie verificate pentru a nu se deteriora. Dacă vreun element al produsului este deteriorat, vă rugăm să vă abțineți de la instalarea produsului și să depuneți o reclamație. Instalarea produsului pe baza elementelor deteriorate înseamnă acceptarea de către Cumpărător a stării lor, ceea ce înseamnă că reclamația privind elementele deteriorate nu va fi acceptată.

Valorile maxime de sarcină specificate nu trebuie depășite. În caz contrar, piesa de mobilier poate fi deteriorată sau distrusă.

Înainte de suspendarea unei piese de mobilier sau atașarea acestuia la perete (pentru a preveni bascularea), verificați în prealabil tipul și gradul de rezistență a peretelui. Montați diblurile și șuruburile adecvate pentru tipul de perete. În caz de îndoieli, consultați un specialist. Instalarea trebuie să fie efectuată de către o persoană competentă.

**ES** Antes de comenzar el montaje de los muebles, todos los elementos deben comprobarse en busca de daños. Si algún elemento del producto está dañado, absténgase de instalar el producto y presente una queja. La instalación del producto sobre la base de los elementos dañados supone la aceptación por parte del Comprador de su estado, por lo que no se aceptará la reclamación de elementos dañados.

No se deben exceder los valores de carga máxima especificados. De lo contrario, el mueble puede dañarse o destruirse.

Antes de colgar o fijar el mueble en el muro (a fin de proteger contra el vuelco del mueble), compruebe de antemano la naturaleza y la resistencia de la pared. Seleccione tacos y tornillos adecuados para el tipo de la pared. En caso de duda, consulte a un especialista, debiendo efectuar este montaje una persona competente.

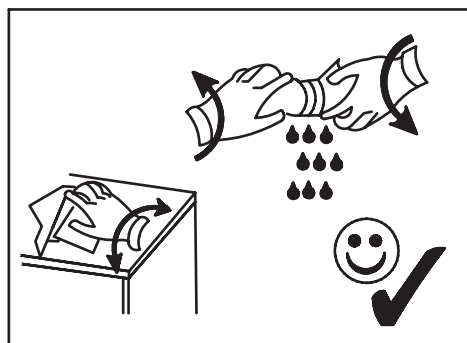
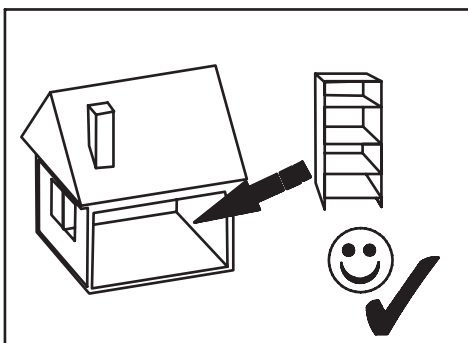
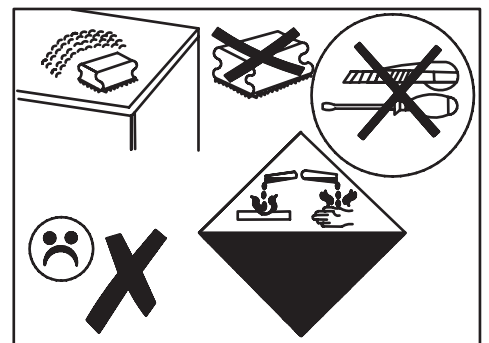
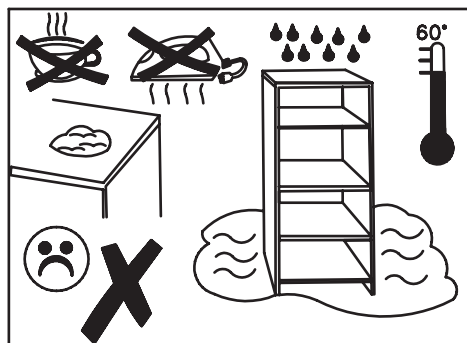
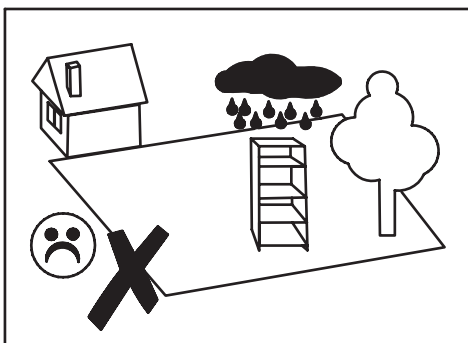

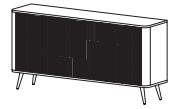

<b>A</b> x24  7x50mm	<b>B</b> x36  8x32mm	<b>C2+D</b> x2  B	<b>C4+D</b> x2  R	<b>DS2</b> x6  H=40mm	<b>E</b> x25  3,5x13mm	<b>E2</b> x8  3x20mm	<b>E3</b> x2  4x27mm	<b>E7</b> x12  4x20mm
<b>EP1</b> x46  4x16mm	<b>H1</b> x7 	<b>K6</b> x3  L=300mm	<b>M</b> x5  L=150mm	<b>N</b> x4  H=180mm	<b>P</b> x8 	<b>R</b> x18  H=11mm	<b>T3</b> x24  5x9mm	<b>T4</b> x6  6,3x24mm
<b>U</b> x18  L=24,3mm	<b>W1</b> x1 	<b>XA</b> x1 	<b>ZA</b> x24  Ø4	<b>ZR</b> x18  Ø15				

C-1	1632	380	16	x 1	1/3
C-2	1632	380	16	x 1	1/3
C-3	600	314	16	x 1	2/3
C-4	600	314	16	x 1	2/3
C-5L	600	338	16	x 1	1/3
C-5P	600	338	16	x 1	1/3
C-6L	600	65	65	x 1	2/3
C-6P	600	65	65	x 1	2/3
C-7	1596	150	16	x 1	1/3
C-8	540	320	16	x 1	2/3
C-9	484	320	16	x 1	2/3
C-10	496	593	18	x 2	2/3
C-11	496	195	18	x 3	2/3
C-12	428	120	16	x 3	1/3
C-13	300	120	16	x 3	1/3
C-14	300	120	16	x 3	1/3
C-15	338	70	16	x 3	2/3
C-16	458	305	3	x 3	1/3
C-17	1612	614	3	x 1	1/3

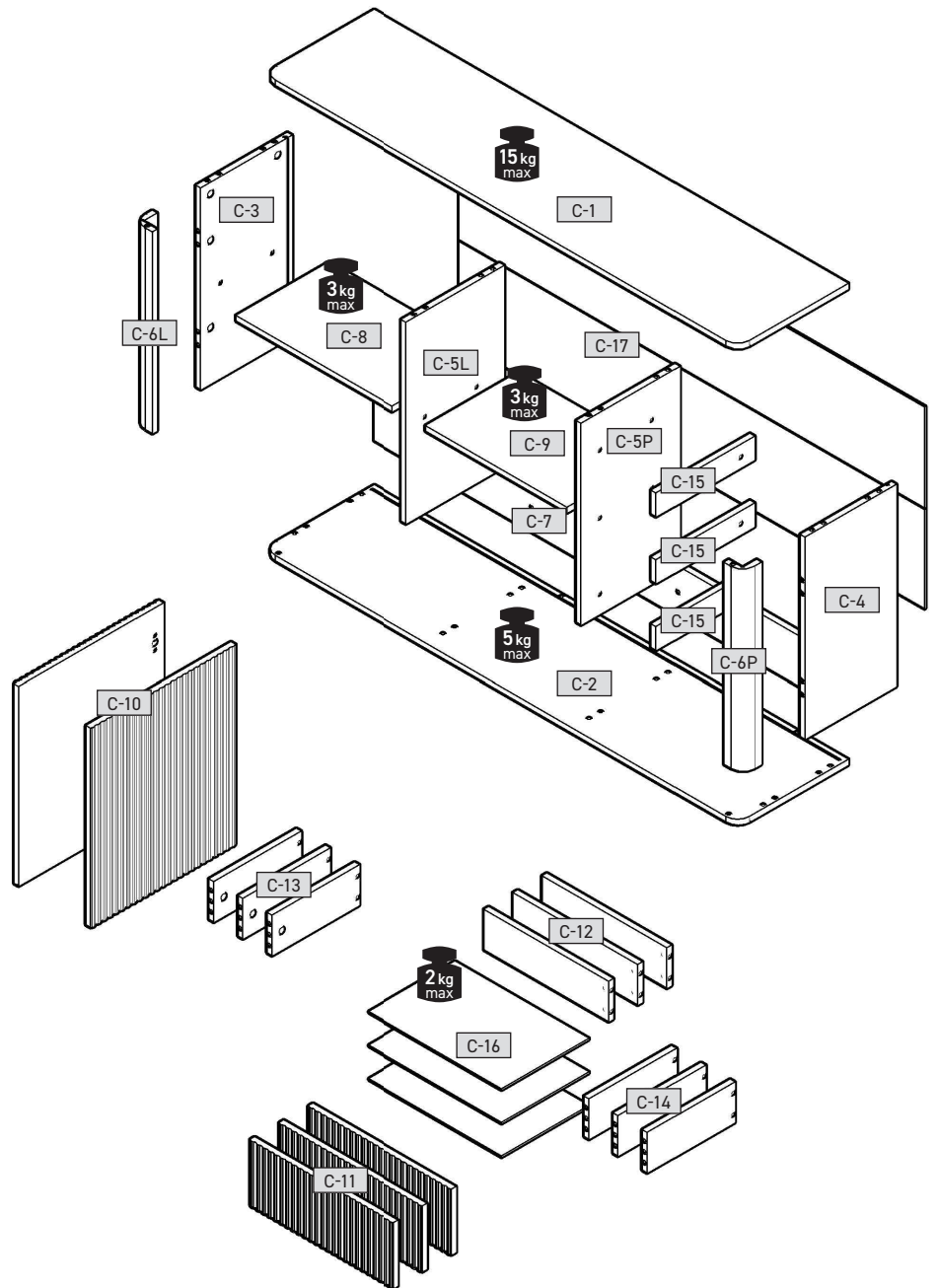

3/3

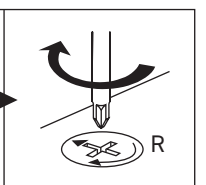
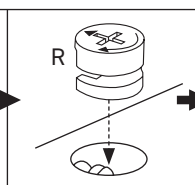
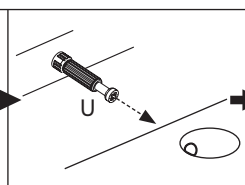
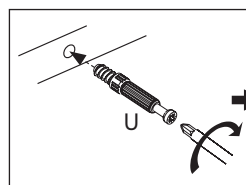
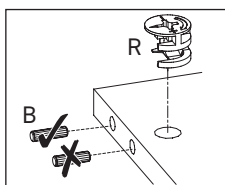
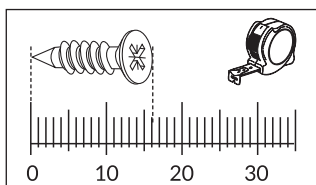
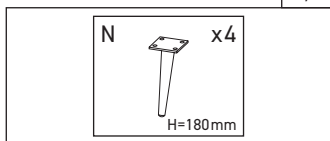

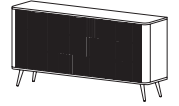

## 1

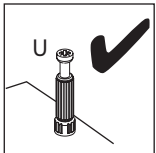
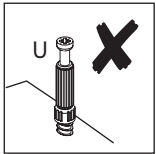
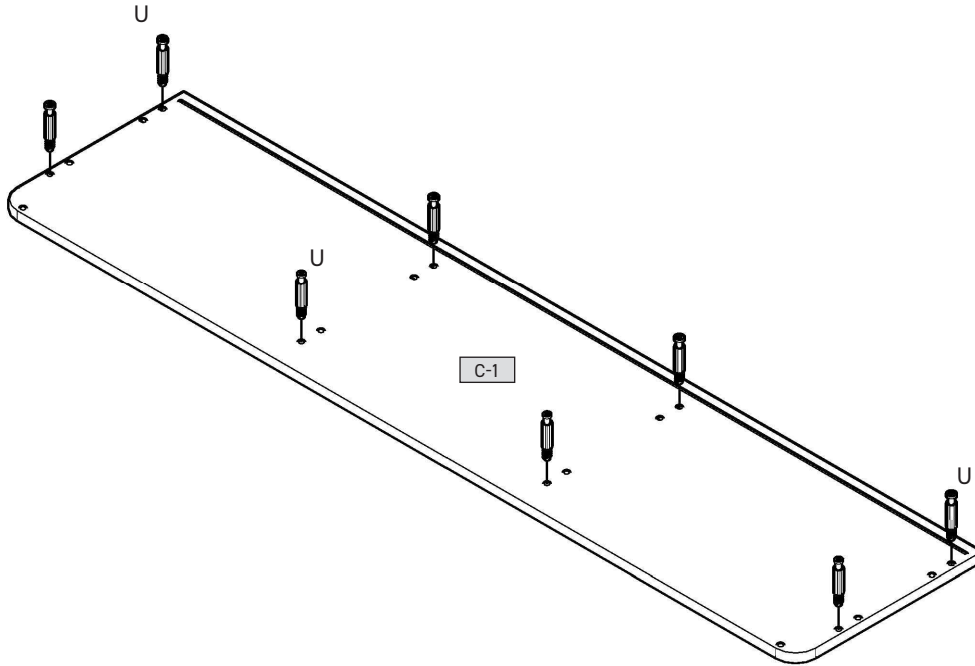
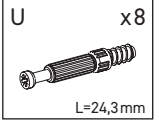

## 2

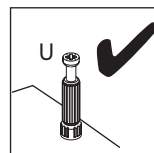
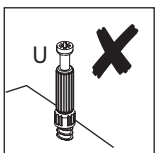
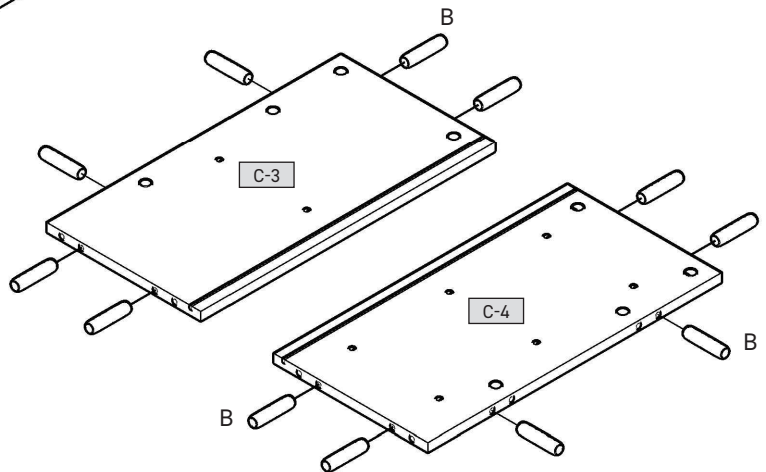
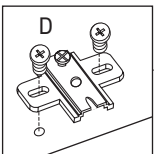
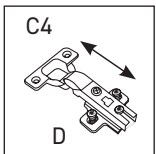
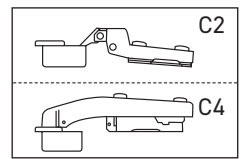
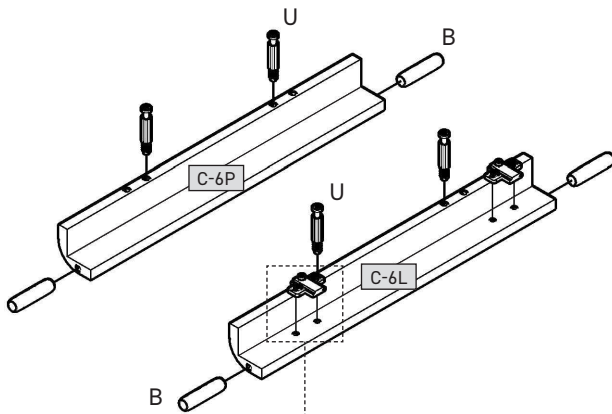
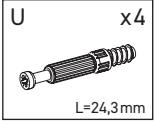
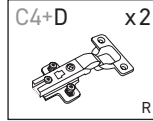
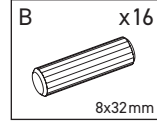



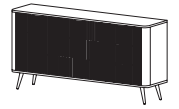

### 3

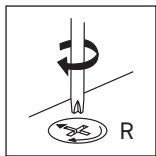
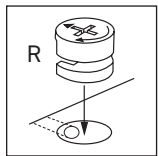
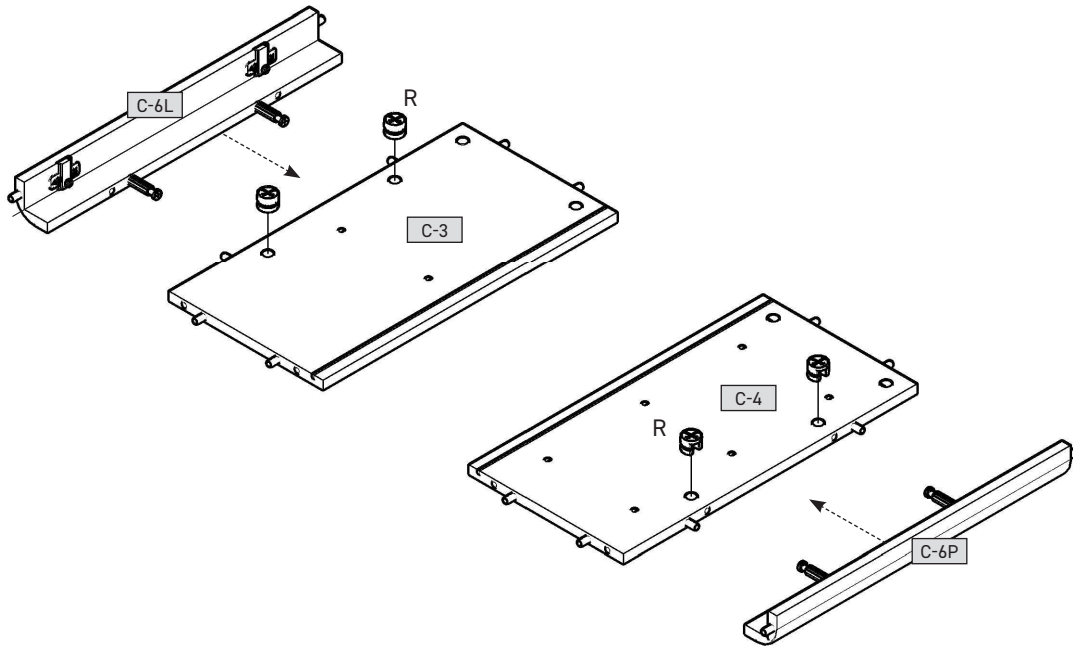
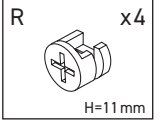

### 4

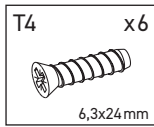

### 5

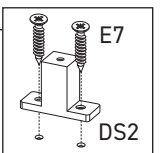
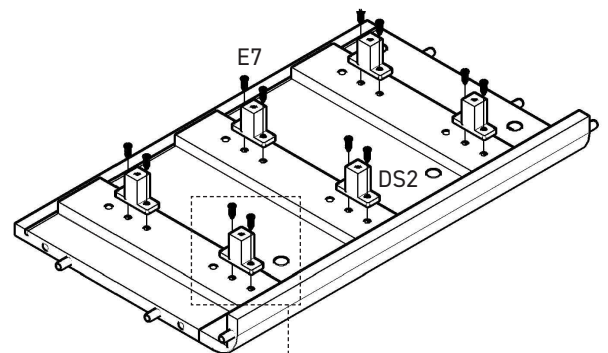
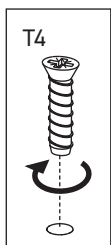
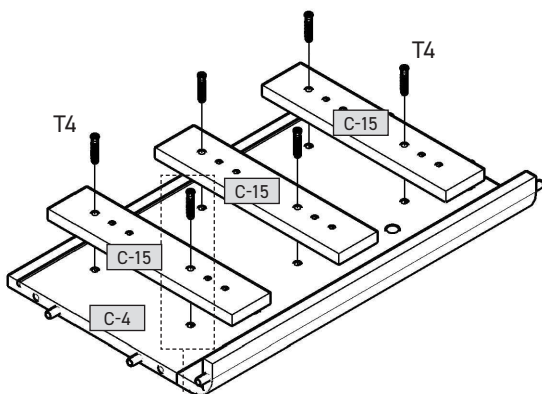
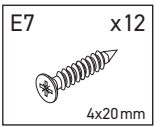
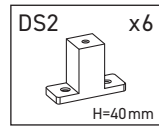

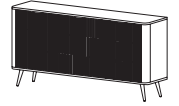

## 6



<b>B</b>	x8	<b>K6</b>	x3	<b>T3</b>	x12
	8x32mm		L=300mm		5x9mm

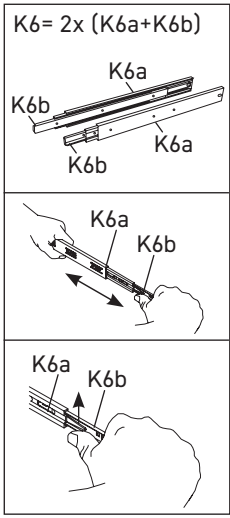
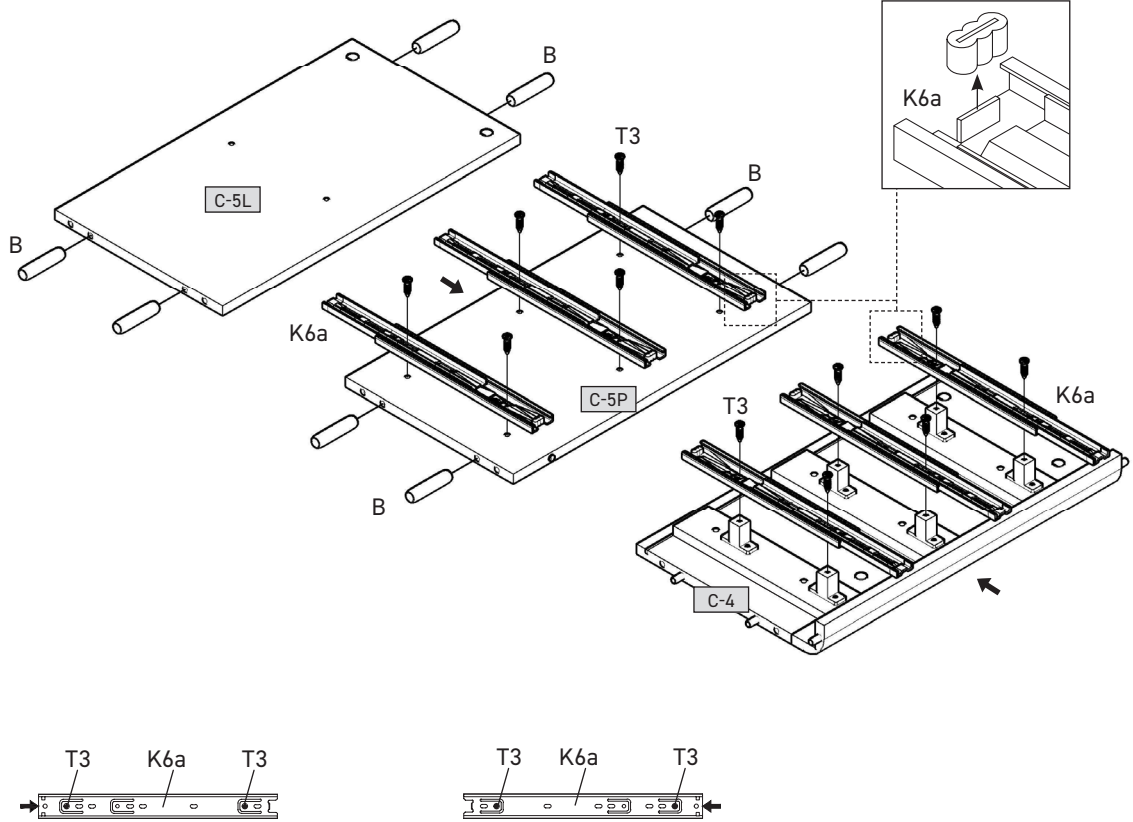

## 7



<b>R</b>	x8
	H=11mm

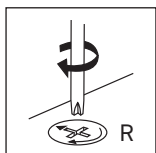
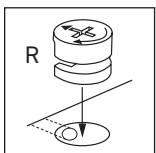
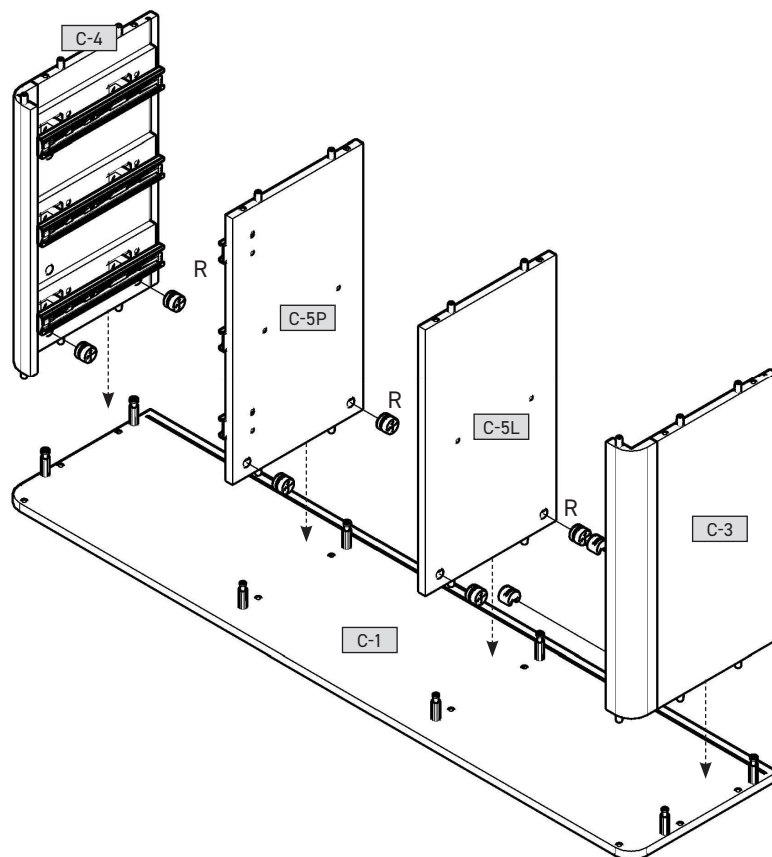

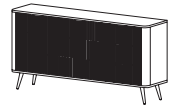

8

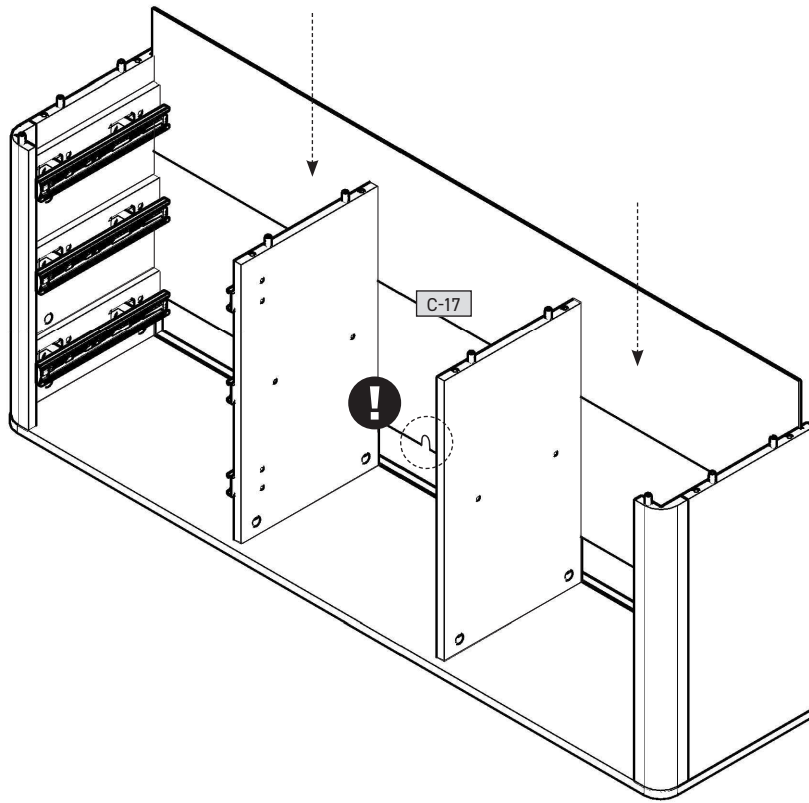

9

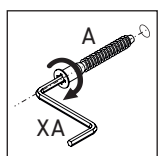
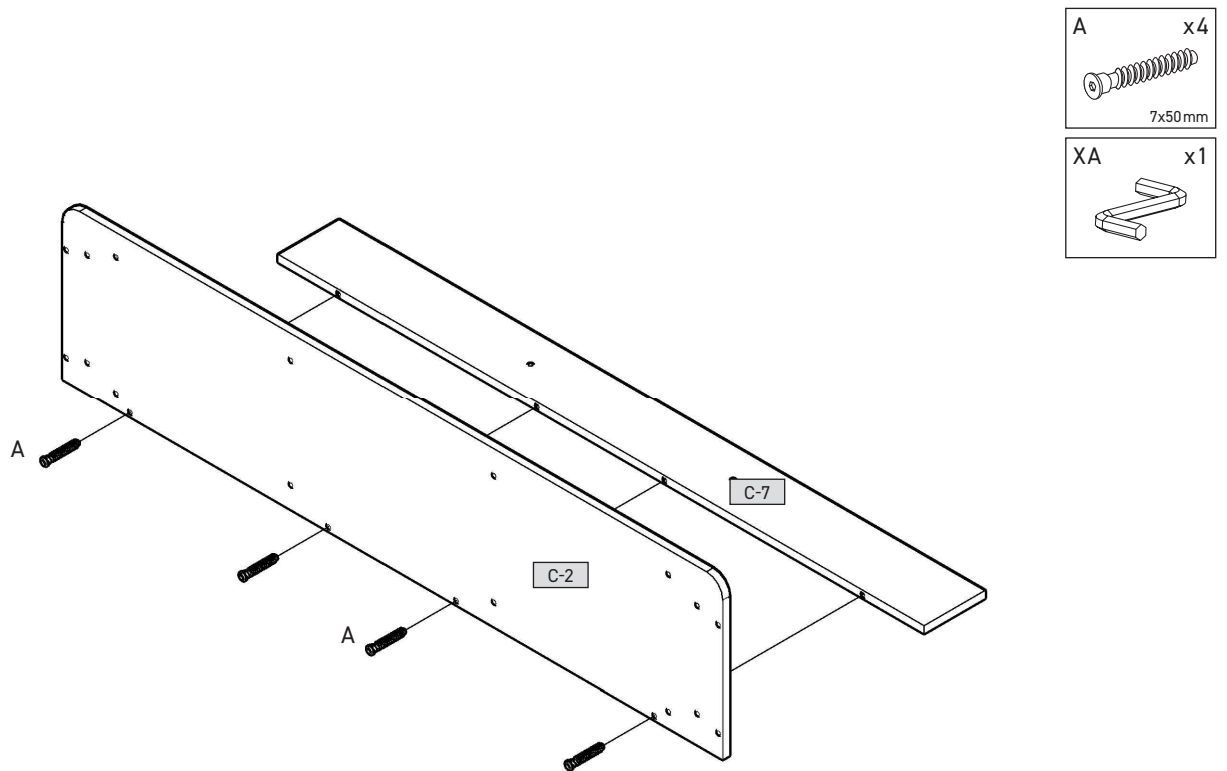

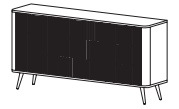

## 10

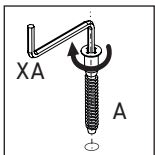
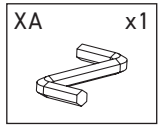
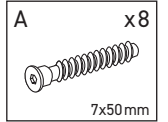
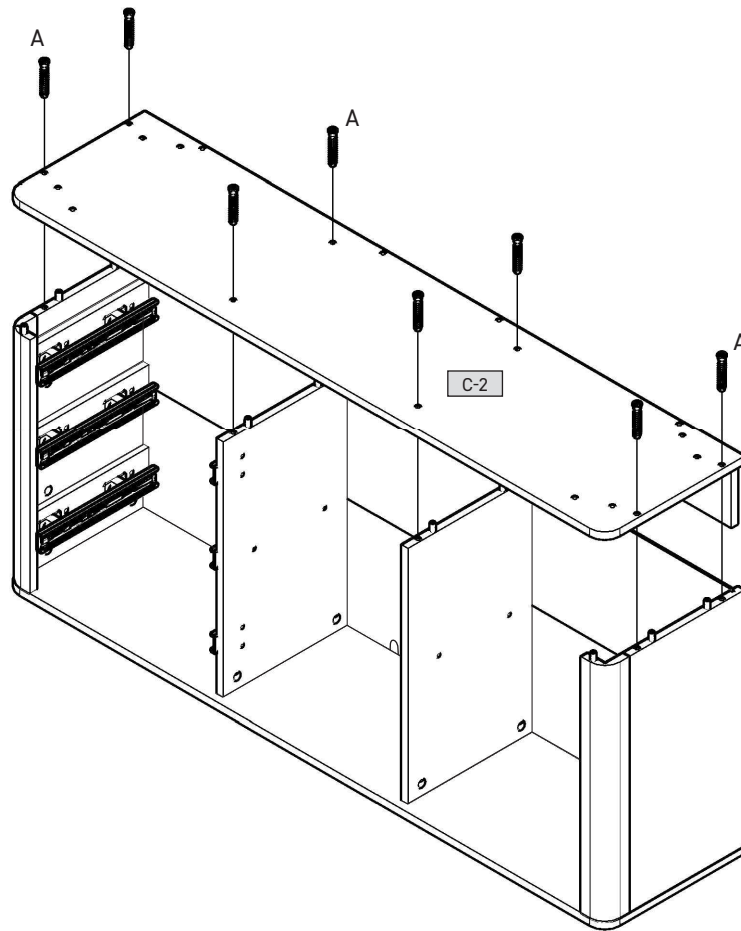

## 11

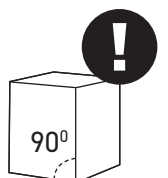
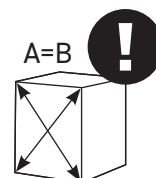
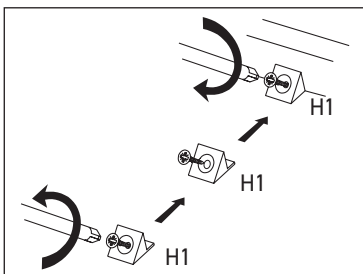
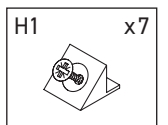
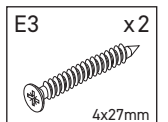
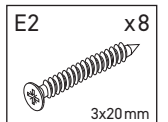
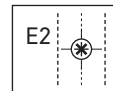
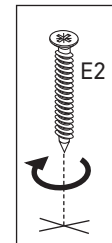
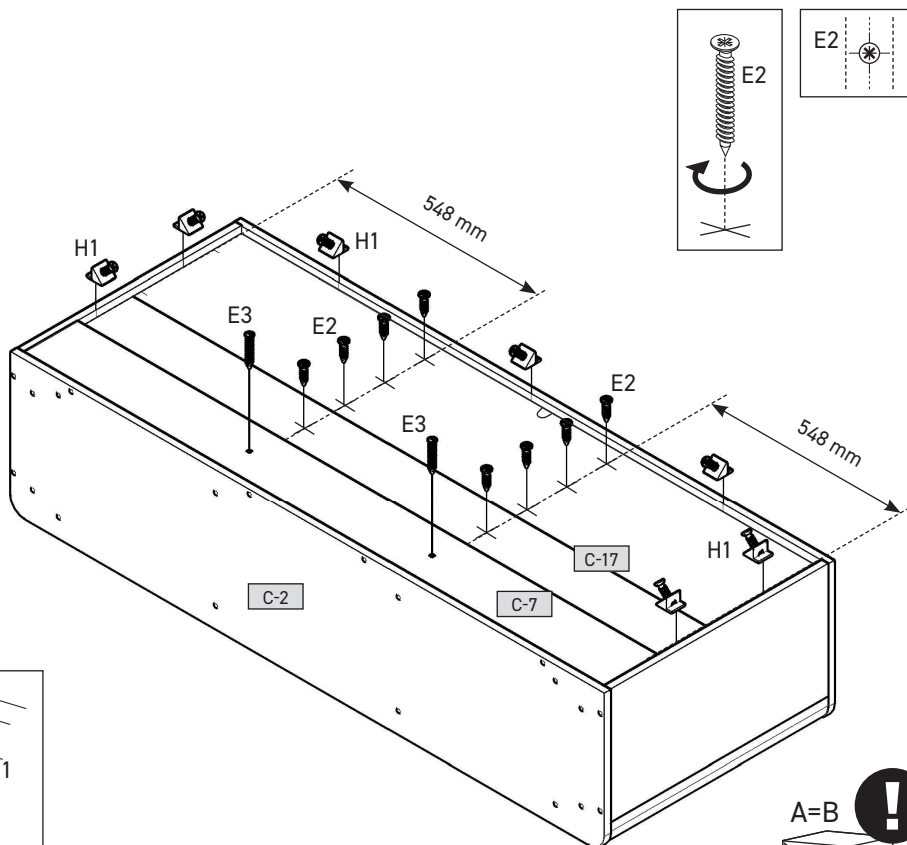

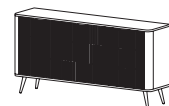

## 12

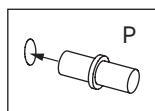
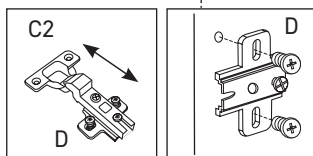
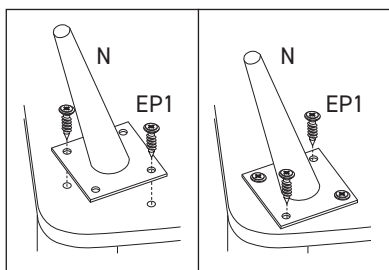
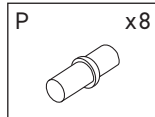
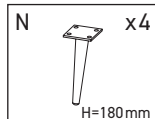
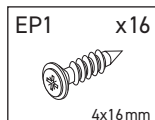
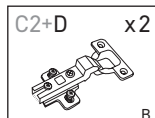
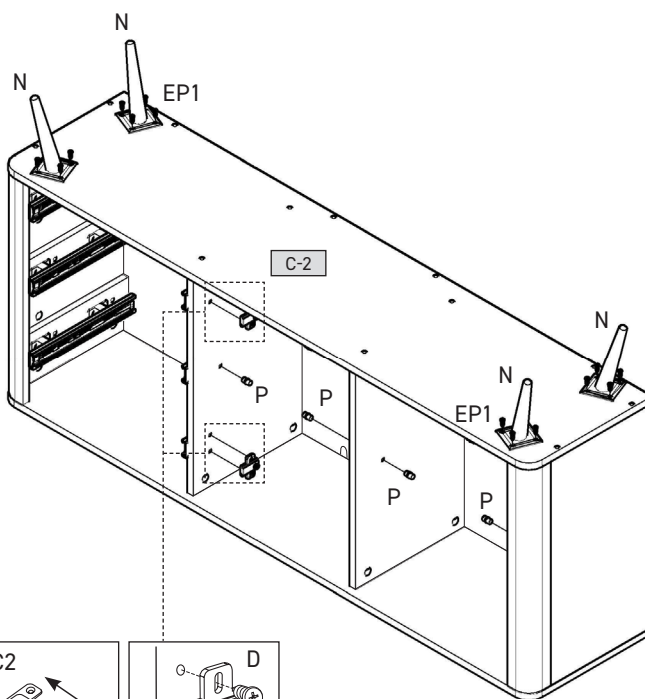

## 13

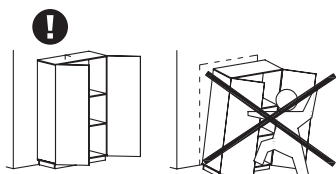
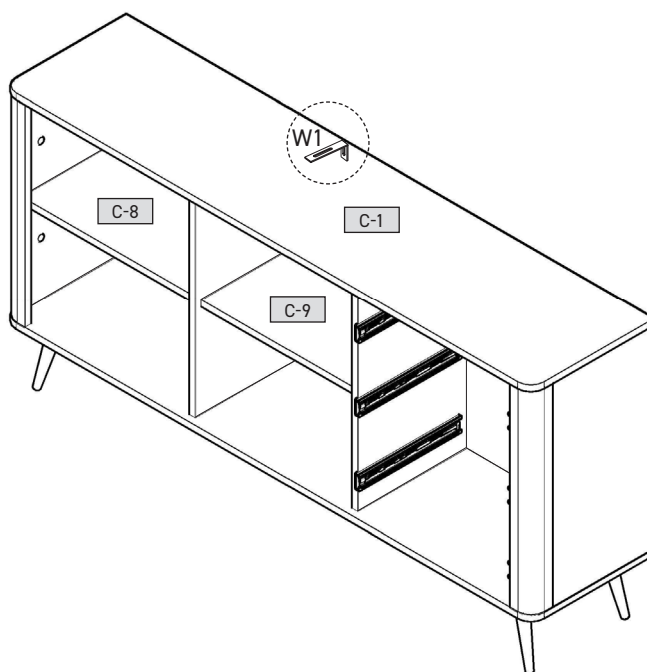
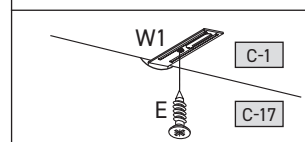
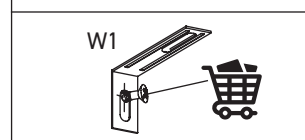
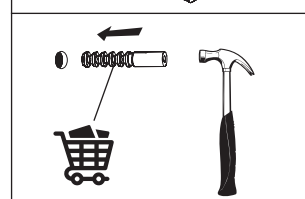
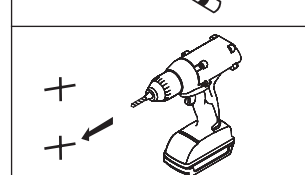
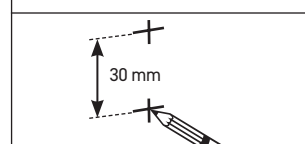
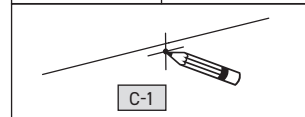
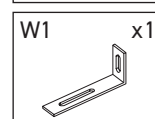
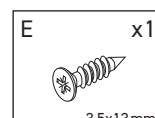
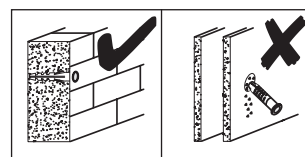
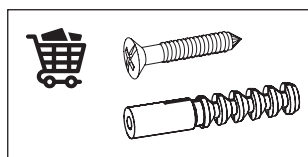
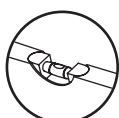

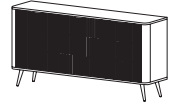

## 14

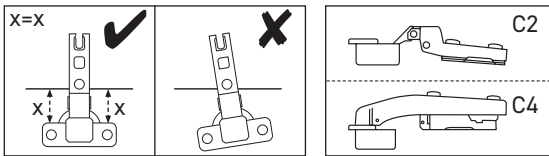
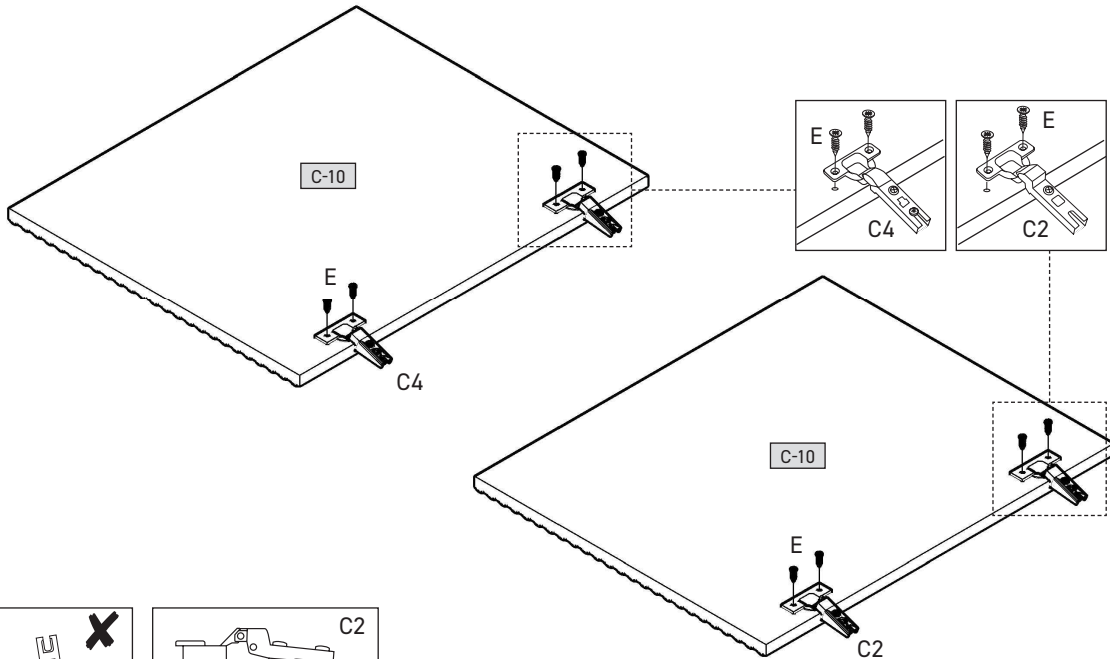
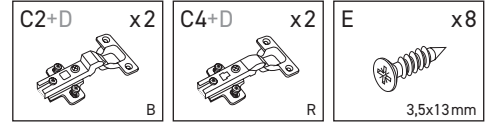

## 15

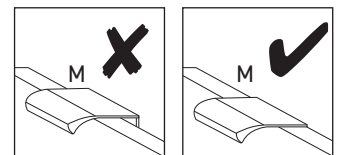
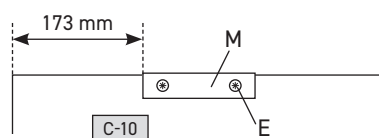
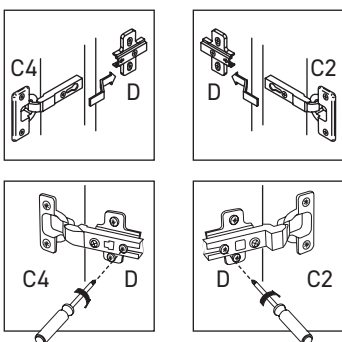
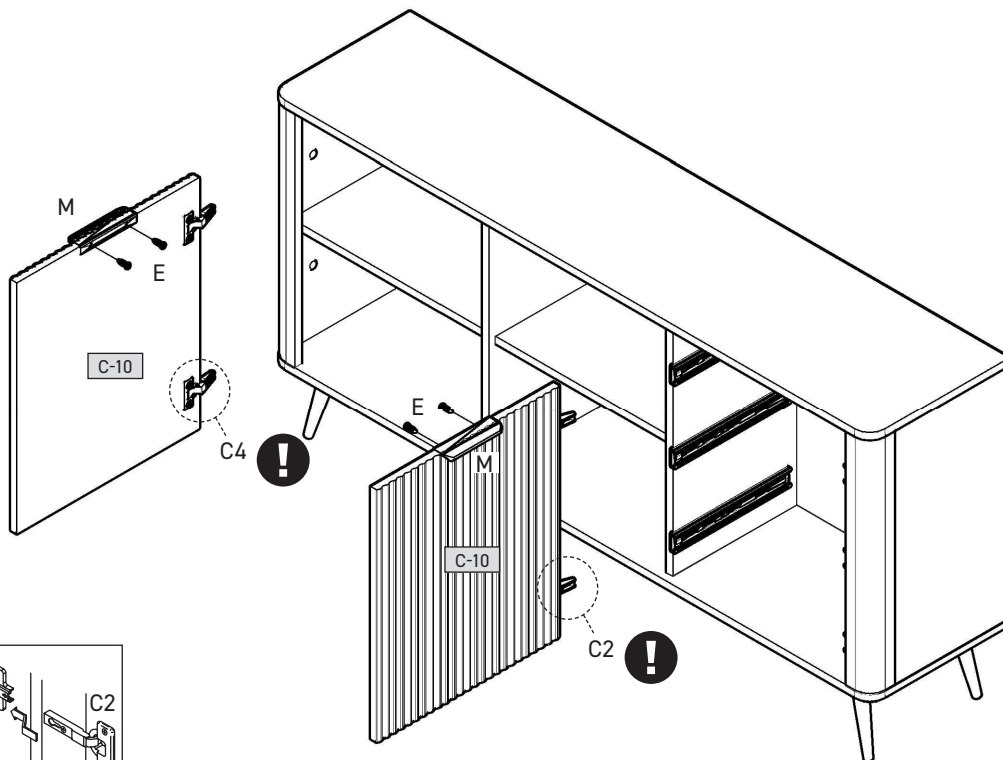
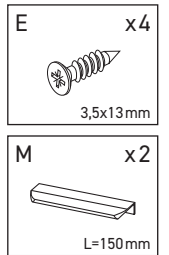



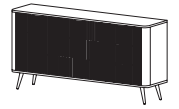

## 16

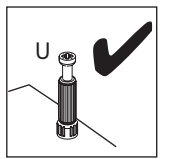
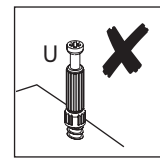
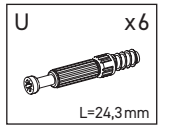
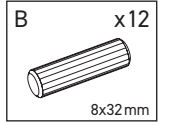
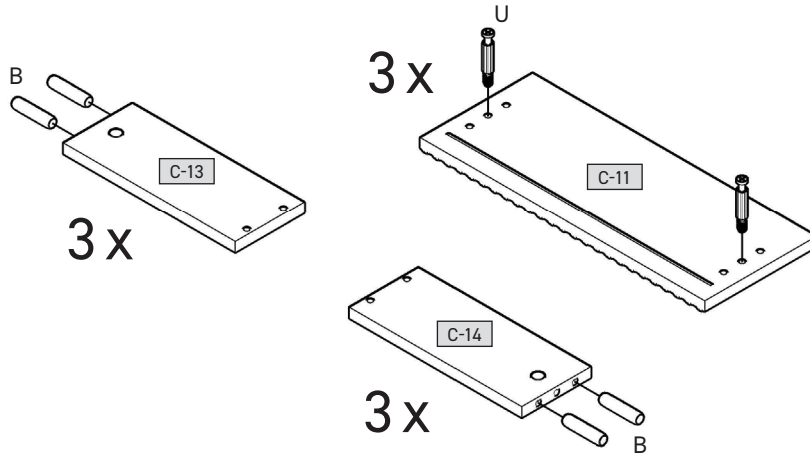

## 17

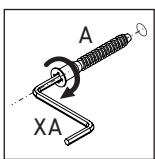
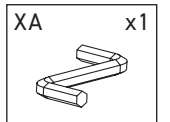
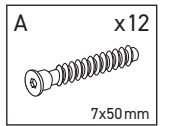
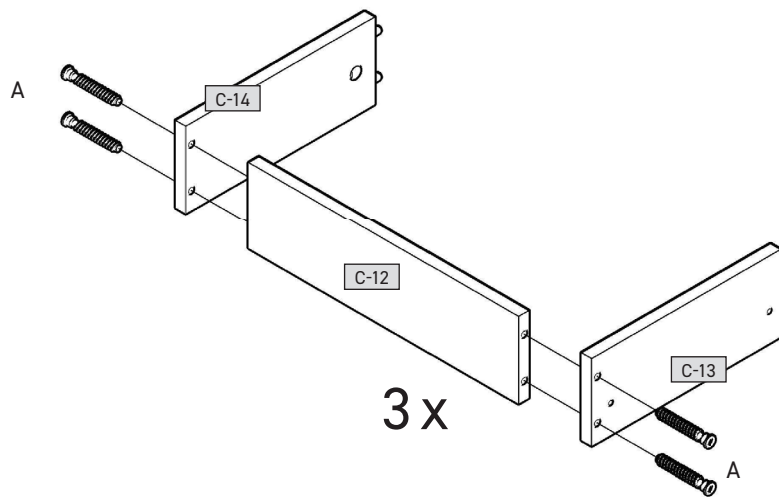

## 18

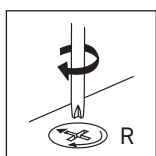
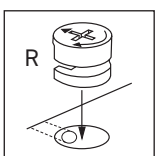
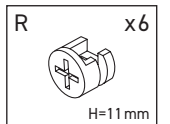
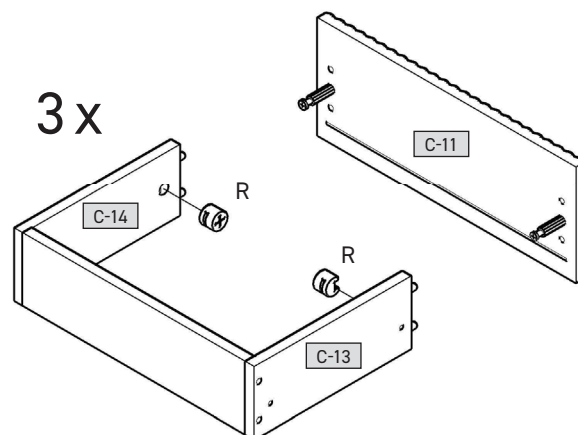

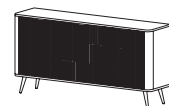

19

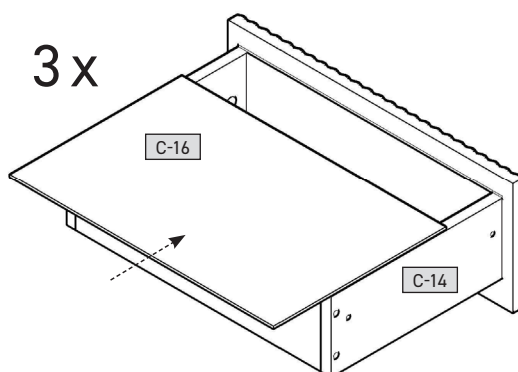

20

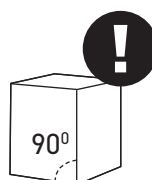
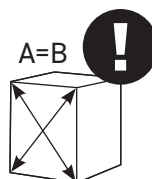
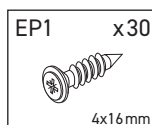
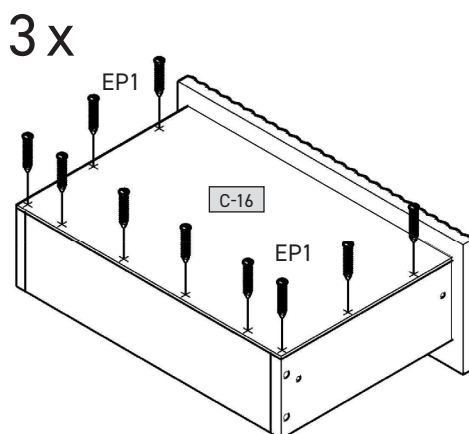
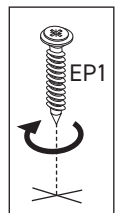

21

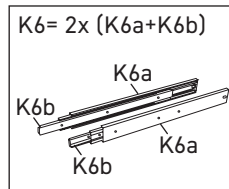
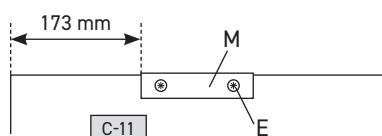
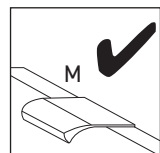
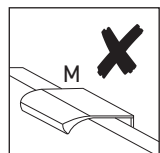
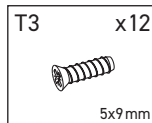
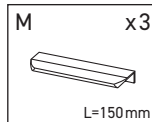
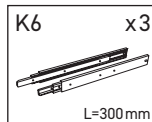
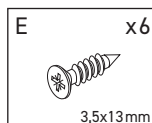
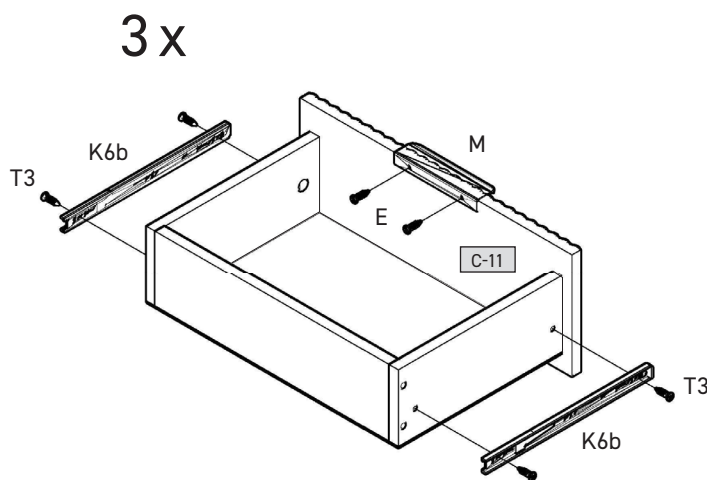

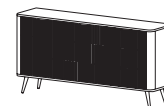

## 22

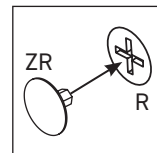
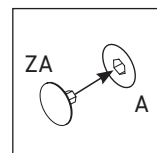
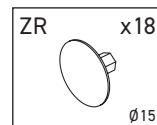
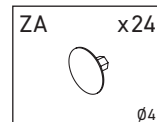
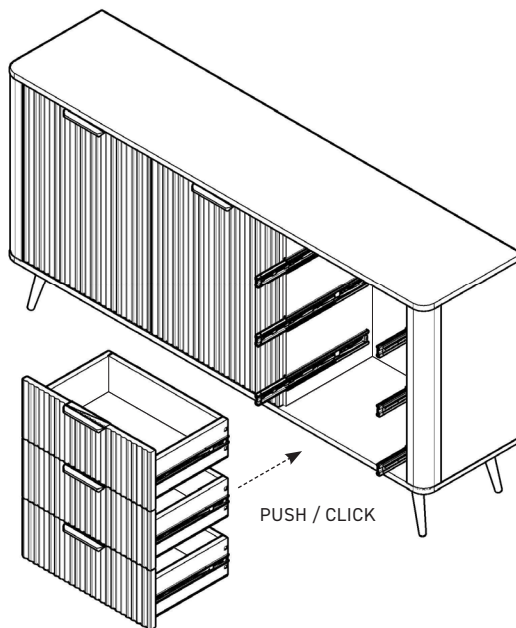

## 23

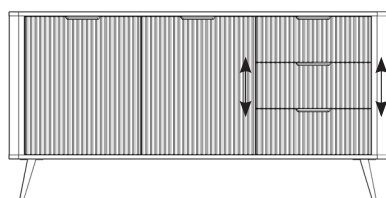
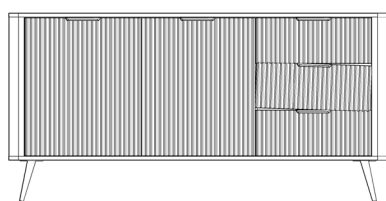

A

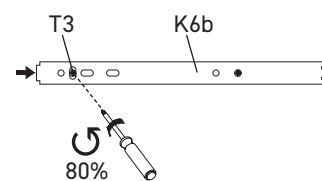
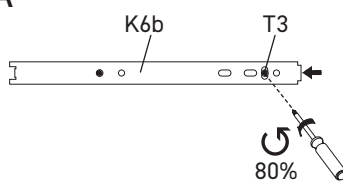

B

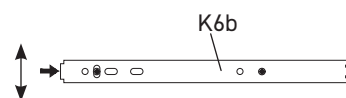
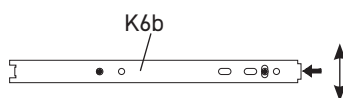

C

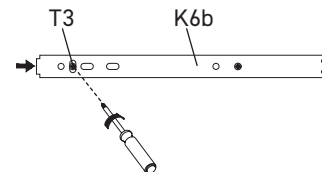
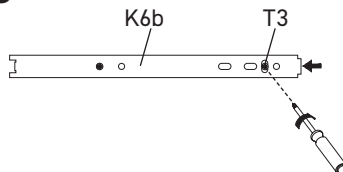

## 24

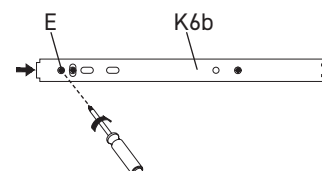
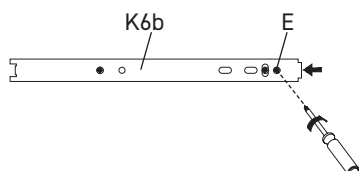
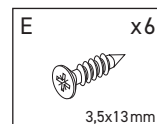
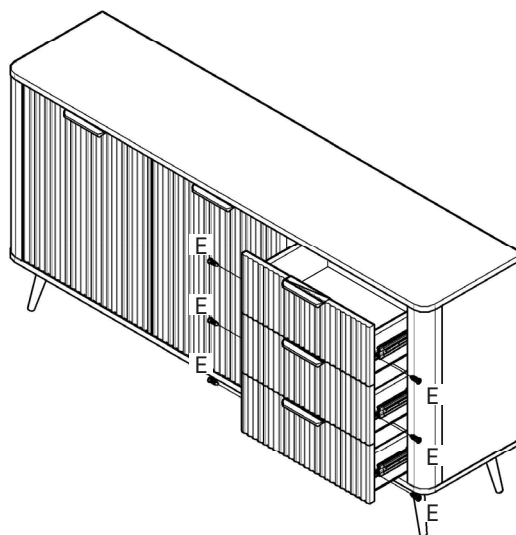

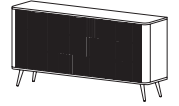

25

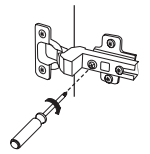
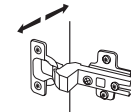
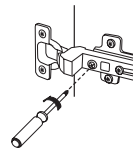
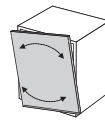
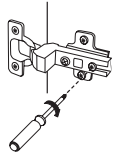
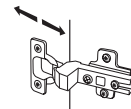
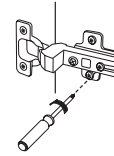
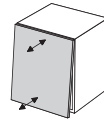
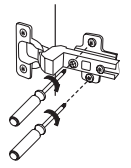
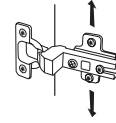
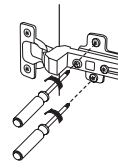
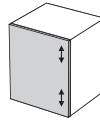
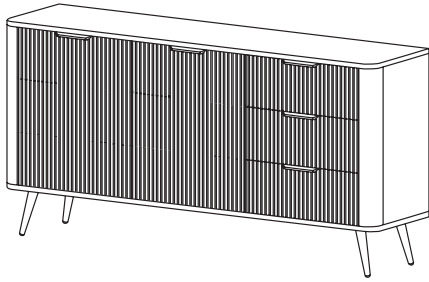

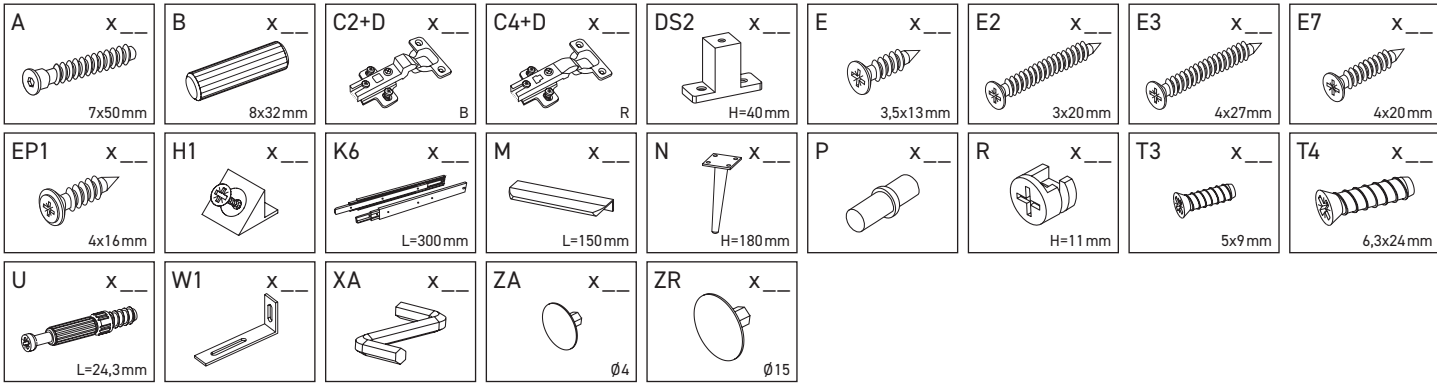

C-1	1632	380	16	x 1	1/3
C-2	1632	380	16	x 1	1/3
C-3	600	314	16	x 1	2/3
C-4	600	314	16	x 1	2/3
C-5L	600	338	16	x 1	1/3
C-5P	600	338	16	x 1	1/3
C-6L	600	65	65	x 1	2/3
C-6P	600	65	65	x 1	2/3
C-7	1596	150	16	x 1	1/3
C-8	540	320	16	x 1	2/3
C-9	484	320	16	x 1	2/3
C-10	496	593	18	x 2	2/3
C-11	496	195	18	x 3	2/3
C-12	428	120	16	x 3	1/3
C-13	300	120	16	x 3	1/3
C-14	300	120	16	x 3	1/3
C-15	338	70	16	x 3	2/3
C-16	458	305	3	x 3	1/3
C-17	1612	614	3	x 1	1/3

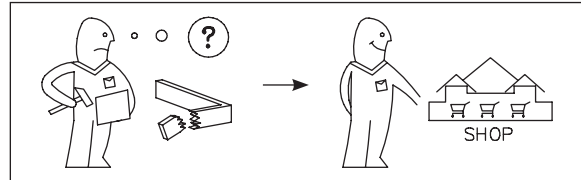
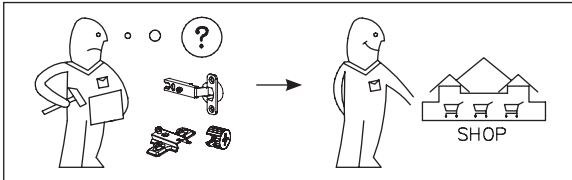
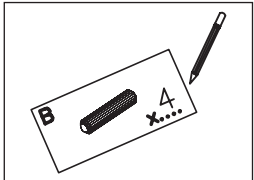
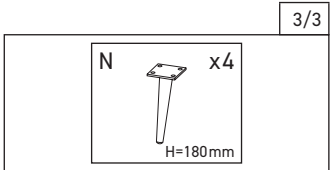
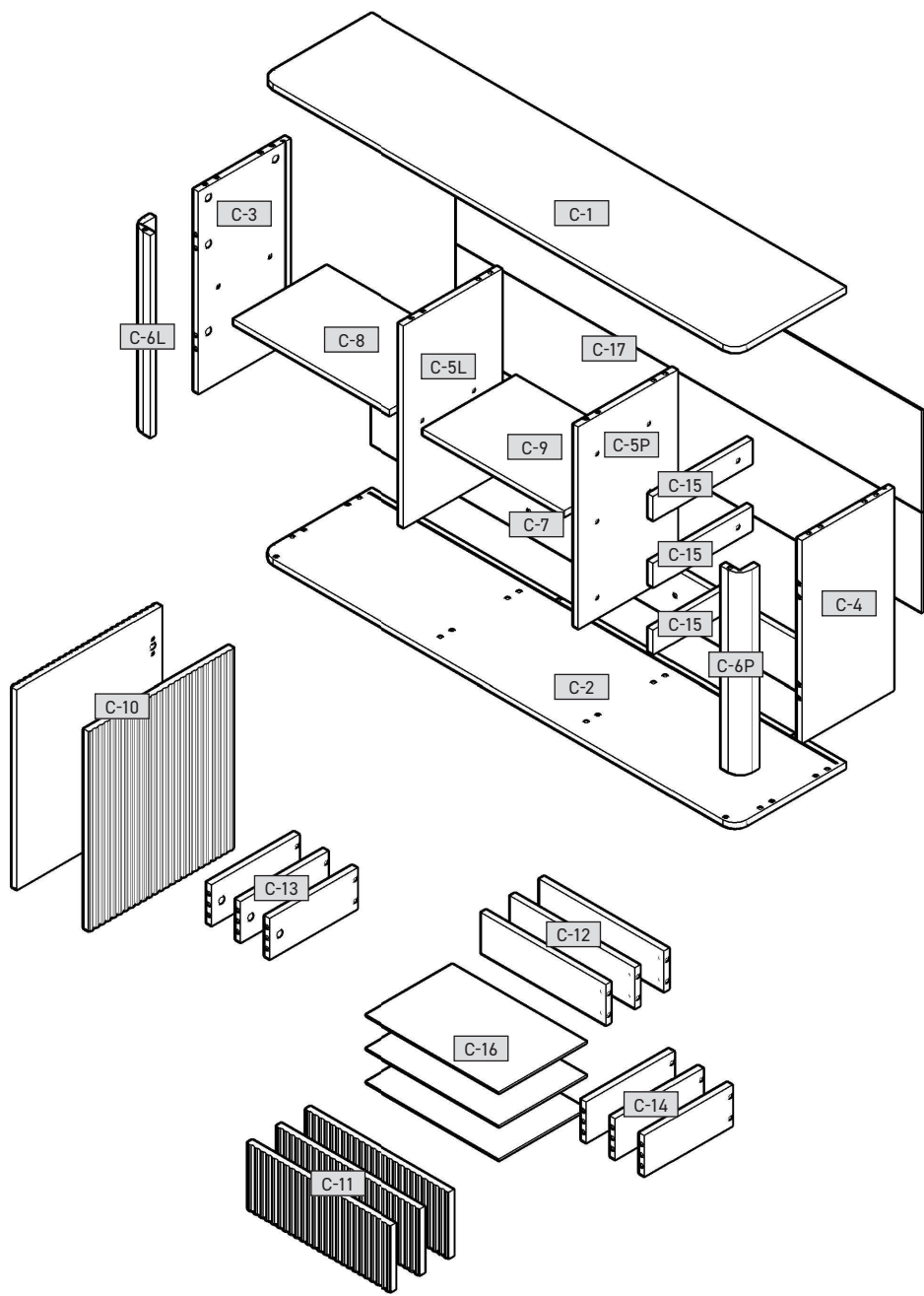









<b><span>DE</span></b>	Möbel aus Naturholz und Plattenwerkstoffen
<b><span>PL</span></b>	Mebel z drewna naturalnego oraz płyt drewnopochodnych
<b><span>NL</span></b>	Meubelen van natuurhout en plaatmateriaal
<b><span>GB</span></b>	Furniture made of natural wood and panel materials
<b><span>IT</span></b>	Mobili in legno naturale e materiali pannellati
<b><span>FR</span></b>	Meuble en bois naturel et plaque en dérivé du bois

<b><span>DE</span></b>	
------------------------	--

**Liebe Kundin,**
**lieber Kunde,**
wir dank Ihnen Bestellung gleichgültig ob Sie ein aus Naturholz gefertigtes Möbelstück gekauft haben, eine Hochglanzfront oder eine matte Kunststofffront – jedes Möbelstück hat seine ganz speziellen Eigenschaften. Auch Holzbeschaffenheit und -struktur, wie zum Beispiel die rere Äste bei Naturholzbeinen, sind Teil der individuellen Ausprägung jedes einzelnen Meubelstücks.

Da Möbel aus Naturholz ständigen Klima- und Feuchtigkeitsschwankungen ausgesetzt sind, können vereinzelt Veränderungen in der Oberfläche auftreten wie z.B. Haarrisse oder Farbveränderungen. Generell nimmt im Laufe der Zeit die Helligkeit ab und die Farbsättigung zu – das Holz dunkelt nach.

Die im Natur-Rohstoff wie Holz ein normaler Prozess.

Dieses Büchlein soll Ihnen ein paar Tipps zur Pflege Ihres Möbelstücks geben, damit Sie lange Freude daran haben können.

**Grundätzlich gilt:**

Möbeln sind Gegenstände auf die wir unsere Aufmerksamkeit richten und die uns Freude bereiten sollen.

- Keine Kratzen direkt auf die Möbel stellen.
- Verschlutete Flüssigkeiten sofort aufwischen.
- In regelmäßigen Abständen einen festen Sitz von Schrauben und Beschlägen kontrollieren.
- Der typische, aromatische Holzgeruch des Naturholzmöbels immer ein wenig erfrischen.
- Heiße Stellen an den Händen entstehen durch einen natürlichen Hautausstritt und können mit einem trockenen, fusselfreien Tuch abpoliert werden.

• Auch von anderen Holz-, Lack-, Leder- oder Polstermaterialien ist unvermeidbar. Diese Gerüche können durch regelmäßiges Lüften von allen Werten des Möbels entfernt werden.
• Wenn Sie den Geruch nicht ertragen können, können Sie die Möbel leicht feucht mit Wasser aus, das mit ein wenig Essig versetzt ist, abwischen.
• Bewahren Sie diese Hinweise gut auf.

**Pflegehinweise für Möbel aus Plattenwerkstoffen**
Verwenden Sie zur Pflege Ihres Möbels aus Plattenwerkstoffen am besten ein weiches, sauberes, nicht abrasives Reinigungsmittel. Wischen Sie die Oberflächen leicht feucht ab.

**Grundsätzlich gilt:**
Verwenden Sie bitte auf keinen Fall folgende Reinigungs- und Pflegemittel:

- **Microfasererleder** oder **Schmutzradierer**. Diese entziehen häufig feine Schmelzpartikel, die zu einem Zerknätzen der Oberfläche führen können.
- **Scharfe chemische Substanzen** wie **scheuernde Putz- oder Lösungsmittel**. Diese können die Oberflächen ebenfalls beschädigen;
- **Scheuerpulver**, **Stahlwolle** oder **Poliermittel**. Sie zerstören die Oberfläche so stark, dass eine Aufarbeitung nicht mehr möglich ist;
- **Staubsauger** und **Bürsten** können die Oberflächen durch ihren Druck und die Hitze, mit denen der Wasserdampf auf die Oberflächen trifft, können diese beschädigt werden oder sich sogar vom Untergrund ablösen.

## Ihre Produktentwicklung

<b><span>TR</span></b>	Doğal ahşap ve kereste malzemelerden Üretilmiş mobilyalar
------------------------	---

<b><span>RU</span></b>	Мебель из натурального дерева и древесных панелей.
------------------------	--

<b><span>RO</span></b>	Mobilă din lemn natural și materiale fibrolemnoase
------------------------	--

<b><span>CZ</span></b>	Nábytek z přírodního dřeva a deskových materiálů
------------------------	--

<b><span>SK</span></b>	Nábytok z prírodného dreva a drevovláknitých deskových materiálov
------------------------	---

<b><span>HU</span></b>	Bűtor természetes faanyagból és bútórappalkó
------------------------	--

<b><span>TR</span></b>	Doğal ahşap ve kereste malzemelerden Üretilmiş mobilyalar
------------------------	---

<b><span>RU</span></b>	Мебель из натурального дерева и древесных панелей.
------------------------	--

<b><span>RO</span></b>	Mobilă din lemn natural și materiale fibrolemnoase
------------------------	--

<b><span>CZ</span></b>	Nábytek z přírodního dřeva a deskových materiálů
------------------------	--

<b><span>SK</span></b>	Nábytok z prírodného dreva a drevovláknitých deskových materiálov
------------------------	---

<b><span>HU</span></b>	Bűtor természetes faanyagból és bútórappalkó
------------------------	--

<b><span>NL</span></b>	
------------------------	--

**Beste klant,**
Hartelijk dank voor uw bestelling! Het maakt niet uit of u een meubelstuk heeft besteld of een plastic voorkant voor een van onze meubels. Het is heel gebruikelijk dat de afwerking van de af te bezichtigen objecten van de bovenlaag zoals haarscherptes of kleurveranderingen. In het algemeen neemt na verloop van tijd de helderheid af en de kleurverzadiging toe – het hout wordt donkerder.

De genoemde wijzigingen vormen bij een natuurlijke grondstof zoals hout een normaal proces. Dit boekje helpt u een paar tips geven die u helpen om de natuurlijke schoonheid van uw meubelstuk te behouden en er lang plezier aan kunt beleven.

**In principe geldt:**

- Plaats geen hete voorwerpen op de meubelen.
- Plaats geen kaarsen direct op de meubelen.
- Veeg gemorst vloeistoffen direct af.
- Controleer met regelmatige intervallen de beslag- en scharnieren van de meubelen.
- De typische, aromatische houtgeur is steeds een kwaliteitsbewijs bij natuurhouten meubelen.
- Heldere plaatsen aan de takken ontstaan door een natuurlijk uitdrennen van hars en kunnen worden weggepoijst met een droge, pluisjevrije doek.
- Ook van andere hout-, lak-, leder- of polstermaterialen is onvermeidbaar. Deze geuren kunnen door regelmatig ventileren van alle meubelen worden verwijderd.
- Wanneer u de geur niet ergeren kunt, kunt u de meubelen licht vochtig met water, dat een beetje is aangelengd met azijn, schoonmaken.
- Bewaar deze instructies goed.

**Onderbouwstructuur voor meubelen**
Gebruik voor de reiniging van uw meubel plaatmateriaal het best een zachte, niet pluisdige doek of een leren doek. Veeg de oppervlakten leraf vochtig af.

**In principe geldt:**
Gebruik zeker niet volgende reinigings- en poetsmiddelen:
• **microvezelrupsen** of **poetsmiddelen**. Deze bevatten vaak fijne slijpdeeltjes die de lak of het hout van uw meubel kunnen beschadigen;

• **scherpe chemische substanties** zoals **schuurpapier**, **staalwol** of **pannensponzen**. Deze kunnen de oppervlakken eveneens beschadigen;

• **schuurpoeder**, **staalwol** of **pannensponzen**. Ze vernietten het oppervlak zo erg dat een reparatie niet meer mogelijk is;

• **stofzuiger**. Mondstukken en borstels kunnen beschadigen op de oppervlakten van de meubelen;

• **stoomreiniger**. Door de hoge druk en de hitte, waarmee de stoom op de bovenlagen komt, kunnen deze worden beschadigd of zelfs loskomen van de ondergrond.

### De productontwikkelingsafdeling

<b><span>TR</span></b>	Doğal ahşap ve kereste malzemelerden Üretilmiş mobilyalar
------------------------	---

<b><span>RU</span></b>	Мебель из натурального дерева и древесных панелей.
------------------------	--

<b><span>RO</span></b>	Mobilă din lemn natural și materiale fibrolemnoase
------------------------	--

<b><span>CZ</span></b>	Nábytek z přírodního dřeva a deskových materiálů
------------------------	--

<b><span>SK</span></b>	Nábytok z prírodného dreva a drevovláknitých deskových materiálov
------------------------	---

<b><span>HU</span></b>	Bűtor természetes faanyagból és bútórappalkó
------------------------	--

<b><span>TR</span></b>	Doğal ahşap ve kereste malzemelerden Üretilmiş mobilyalar
------------------------	---

<b><span>RU</span></b>	Мебель из натурального дерева и древесных панелей.
------------------------	--

<b><span>RO</span></b>	Mobilă din lemn natural și materiale fibrolemnoase
------------------------	--

<b><span>CZ</span></b>	Nábytek z přírodního dřeva a deskových materiálů
------------------------	--

<b><span>SK</span></b>	Nábytok z prírodného dreva a drevovláknitých deskových materiálov
------------------------	---

<b><span>HU</span></b>	Bűtor természetes faanyagból és bútórappalkó
------------------------	--

<b><span>NL</span></b>	
------------------------	--

**Beste klant,**
Hartelijk dank voor uw bestelling! Het maakt niet uit of u een meubelstuk heeft besteld of een plastic voorkant voor een van onze meubels. Het is heel gebruikelijk dat de afwerking van de af te bezichtigen objecten van de bovenlaag zoals haarscherptes of kleurveranderingen. In het algemeen neemt na verloop van tijd de helderheid af en de kleurverzadiging toe – het hout wordt donkerder.

De genoemde wijzigingen vormen bij een natuurlijke grondstof zoals hout een normaal proces. Dit boekje helpt u een paar tips geven die u helpen om de natuurlijke schoonheid van uw meubelstuk te behouden en er lang plezier aan kunt beleven.

**In principe geldt:**

- Plaats geen hete voorwerpen op de meubelen.
- Plaats geen kaarsen direct op de meubelen.
- Veeg gemorst vloeistoffen direct af.
- Controleer met regelmatige intervallen de beslag- en scharnieren van de meubelen.
- De typische, aromatische houtgeur is steeds een kwaliteitsbewijs bij natuurhouten meubelen.
- Heldere plaatsen aan de takken ontstaan door een natuurlijk uitdrennen van hars en kunnen worden weggepoijst met een droge, pluisjevrije doek.
- Ook van andere hout-, lak-, leder- of polstermaterialen is onvermeidbaar. Deze geuren kunnen door regelmatig ventileren van alle meubelen worden verwijderd.
- Wanneer u de geur niet ergeren kunt, kunt u de meubelen licht vochtig met water, dat een beetje is aangelengd met azijn, schoonmaken.
- Bewaar deze instructies goed.

**Onderbouwstructuur voor meubelen**
Gebruik voor de reiniging van uw meubel plaatmateriaal het best een zachte, niet pluisdige doek of een leren doek. Veeg de oppervlakten leraf vochtig af.

**In principe geldt:**
Gebruik zeker niet volgende reinigings- en poetsmiddelen:
• **microvezelrupsen** of **poetsmiddelen**. Deze bevatten vaak fijne slijpdeeltjes die de lak of het hout van uw meubel kunnen beschadigen;

• **scherpe chemische substanties** zoals **schuurpapier**, **staalwol** of **pannensponzen**. Deze kunnen de oppervlakken eveneens beschadigen;

• **schuurpoeder**, **staalwol** of **pannensponzen**. Ze vernietten het oppervlak zo erg dat een reparatie niet meer mogelijk is;

• **stofzuiger**. Mondstukken en borstels kunnen beschadigen op de oppervlakten van de meubelen;

• **stoomreiniger**. Door de hoge druk en de hitte, waarmee de stoom op de bovenlagen komt, kunnen deze worden beschadigd of zelfs loskomen van de ondergrond.

<b><span>GB</span></b>	
------------------------	--

<b><span>IT</span></b>	
------------------------	--

<b><span>FR</span></b>	
------------------------	--

<b><span>TR</span></b>	Doğal ahşap ve kereste malzemelerden Üretilmiş mobilyalar
------------------------	---

<b><span>RU</span></b>	Мебель из натурального дерева и древесных панелей.
------------------------	--

<b><span>RO</span></b>	Mobilă din lemn natural și materiale fibrolemnoase
------------------------	--

<b><span>CZ</span></b>	Nábytek z přírodního dřeva a deskových materiálů
------------------------	--

<b><span>SK</span></b>	Nábytok z prírodného dreva a drevovláknitých deskových materiálov
------------------------	---

<b><span>HU</span></b>	Bűtor természetes faanyagból és bútórappalkó
------------------------	--

<b><span>TR</span></b>	Doğal ahşap ve kereste malzemelerden Üretilmiş mobilyalar
------------------------	---

<b><span>RU</span></b>	Мебель из натурального дерева и древесных панелей.
------------------------	--

<b><span>RO</span></b>	Mobilă din lemn natural și materiale fibrolemnoase
------------------------	--

<b><span>CZ</span></b>	Nábytek z přírodního dřeva a deskových materiálů
------------------------	--

<b><span>SK</span></b>	Nábytok z prírodného dreva a drevovláknitých deskových materiálov
------------------------	---

<b><span>HU</span></b>	Bűtor természetes faanyagból és bútórappalkó
------------------------	--

**Dear customer,**
Thank you for your order! No matter if you bought a piece of furniture made from natural wood, a high-gloss front or a plastic front – every piece of furniture has unique characteristics. Even the texture and structure of wood, such as small knots in natural wood furniture, are part of the individual charisma of each piece of furniture.

Since natural wood furniture are permanently exposed to climate and humidity fluctuations, changes to the surface may occur (e.g. hair cracks or changes in colour) in some cases. In general, brightness decreases and colour saturation increases in the course of time – the wood darkens.

The changes mentioned above are normal for natural raw materials such as wood. This booklet provides some care tips for your piece of furniture so that you can enjoy it for a long time.

- Don't place any hot objects on the furniture.
- Don't place candles directly on the furniture.
- Immediately wipe off any spilled liquids.
- Regularly check if the screws and fittings are tight.
- The typical, aromatic wooden odour is always a proof of quality for natural wood furniture.
- The natural emission of resin may produce bright spots on the knots which can be polished with a dry, lintfree cloth.
- Initially, a slight intrinsic odour is unavoidable for other wooden, paint, leather or upholstery materials too.
- These odours automatically disappear after a while. If you want to speed up this process, ventilate more often at the beginning and/or wipe out the furniture with a slightly damp cloth which was soaked in water mixed with a small amount of vinegar.
- Keep these notes in a safe place.

### Care notes for furniture made of panel materials

We recommend using a soft, lint-free cloth or a shammy for conditioning your piece of furniture made of panel materials. Wipe off the surfaces with a slightly damp cloth or shammy.

The following applies in general: Please don't use the following detergents or cleaning agents at all:

- **microfibre cloths** or **dirt erasers**. They often contain fine abrasive particles which can cause scratches on the surfaces;
- **aggressive chemical substances** as well as **abrasive cleaning agents** or **solvents**. They may damage the surfaces too;
- **scouring powder**, **steel wool** or **scouring pads**. They destroy the surface so badly that reconditioning is impossible;
- **vacuum cleaners**. The nozzles and brushes can cause scratches on the surfaces;
- **steam cleaners**. The surfaces may be damaged or separated from the ground due to the high pressure and heat of the water vapour.

## Your product development team

<b><span>FR</span></b>	
------------------------	--

<b><span>TR</span></b>	
------------------------	--

<b><span>RU</span></b>	
------------------------	--

<b><span>RO</span></b>	
------------------------	--

<b><span>CZ</span></b>	
------------------------	--

<b><span>SK</span></b>	
------------------------	--

<b><span>HU</span></b>	
------------------------	--

<b><span>TR</span></b>	
------------------------	--

<b><span>RU</span></b>	
------------------------	--

<b><span>RO</span></b>	
------------------------	--

<b><span>CZ</span></b>	
------------------------	--

<b><span>SK</span></b>	
------------------------	--

<b><span>HU</span></b>	
------------------------	--

<b><span>TR</span></b>	
------------------------	--

<b><span>RU</span></b>	
------------------------	--

<b><span>RO</span></b>	
------------------------	--

<b><span>CZ</span></b>	
------------------------	--

<b><span>SK</span></b>	
------------------------	--

<b><span>HU</span></b>	
------------------------	--

<b><span>TR</span></b>	
------------------------	--

<b><span>RU</span></b>	
------------------------	--

<b><span>RO</span></b>	
------------------------	--

<b><span>CZ</span></b>	
------------------------	--

<b><span>SK</span></b>	
------------------------	--

<b><span>HU</span></b>	
------------------------	--

<b><span>TR</span></b>	
------------------------	--

<b><span>RU</span></b>	
------------------------	--

<b><span>RO</span></b>	
------------------------	--

<b><span>CZ</span></b>	
------------------------	--

<b><span>SK</span></b>	
------------------------	--

<b><span>HU</span></b>	
------------------------	--

<b><span>TR</span></b>	
------------------------	--

<b><span>RU</span></b>	
------------------------	--

<b><span>RO</span></b>	
------------------------	--

<b><span>CZ</span></b>	
------------------------	--

<b><span>SK</span></b>	
------------------------	--

<b><span>HU</span></b>	
------------------------	--

<b><span>TR</span></b>	
------------------------	--

<b><span>RU</span></b>	
------------------------	--

<b><span>RO</span></b>	
------------------------	--

<b><span>CZ</span></b>	
------------------------	--

<b><span>SK</span></b>	
------------------------	--

<b><span>HU</span></b>	
------------------------	--

<b><span>TR</span></b>	
------------------------	--

<b><span>RU</span></b>	
------------------------	--

<b><span>RO</span></b>	
------------------------	--

<b><span>CZ</span></b>	
------------------------	--

<b><span>SK</span></b>	
------------------------	--

<b><span>HU</span></b>	
------------------------	--

<b><span>TR</span></b>	
------------------------	--

<b><span>RU</span></b>	
------------------------	--

<b><span>RO</span></b>	
------------------------	--

<b><span>CZ</span></b>	
------------------------	--

<b><span>SK</span></b>	
------------------------	--

<b><span>HU</span></b>	
------------------------	--

<b><span>TR</span></b>	
------------------------	--

<b><span>RU</span></b>	
------------------------	--

<b><span>RO</span></b>	
------------------------	--

<b><span>CZ</span></b>	
------------------------	--

<b><span>SK</span></b>	
------------------------	--

<b><span>HU</span></b>	
------------------------	--

<b><span>TR</span></b>	
------------------------	--

<b><span>RU</span></b>	
------------------------	--

<b><span>RO</span></b>	
------------------------	--

<b><span>CZ</span></b>	
------------------------	--

<b><span>SK</span></b>	
------------------------	--

<b><span>HU</span></b>	
------------------------	--

<b><span>TR</span></b>	
------------------------	--

