

Ø10mm  
60 GU-36

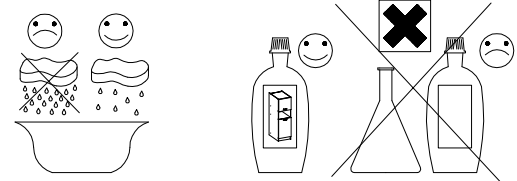

KUH.40001

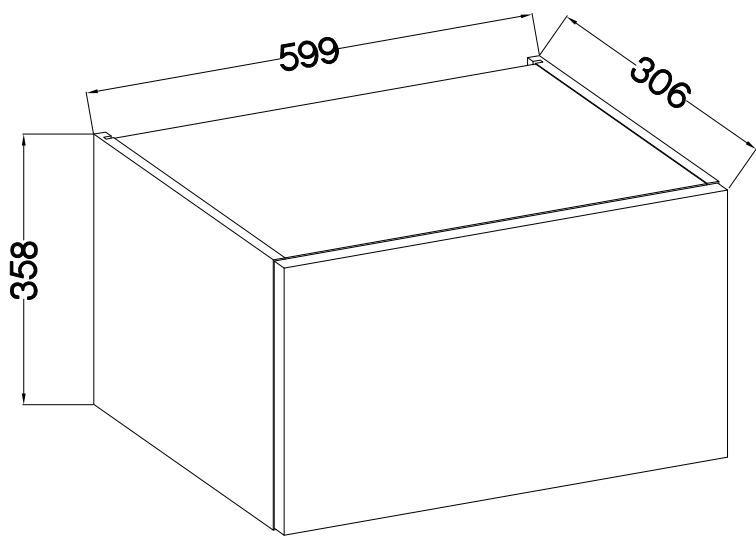

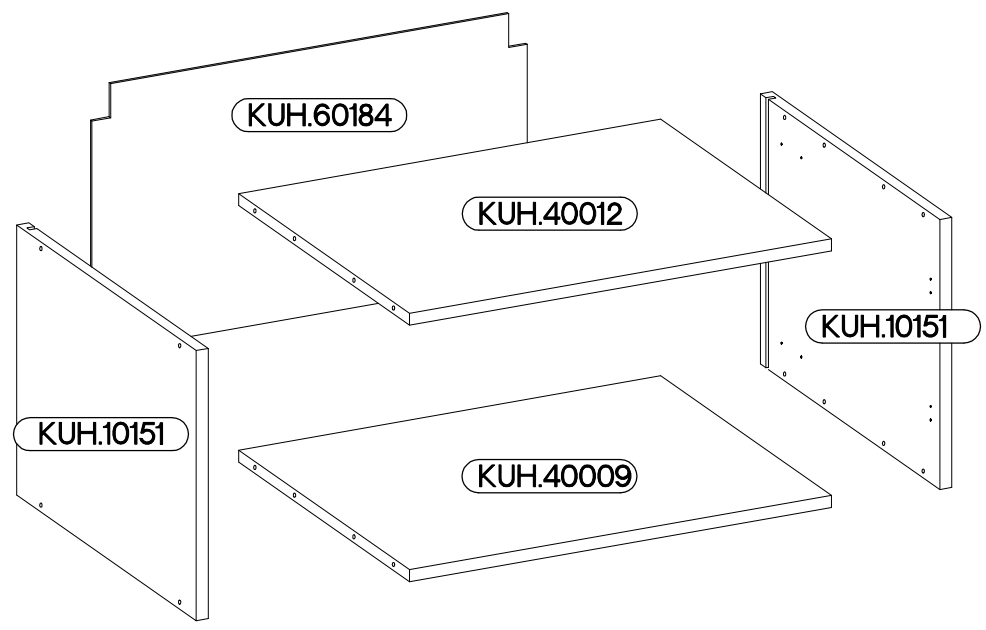
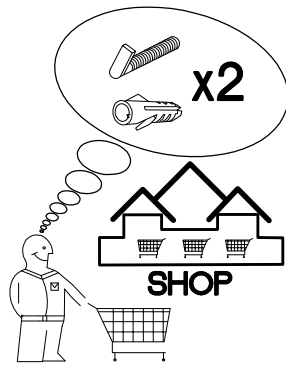
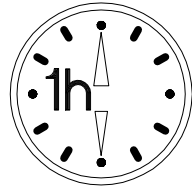

Ersatzteil Nummer	Dimension
KUH.10151 x2	358x290x16
KUH.40009	567x276x16
KUH.40012	567x276x16
KUH.60184	353x585x2,5

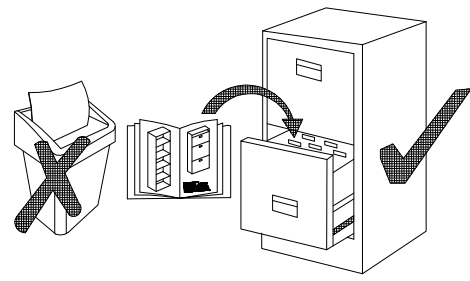
 A 8	 B 8	 E1 8	 HG 2
 K 2	 K24 2	 O 1	 P5 4
			 P7 8-10
			 P8 4



ISM-KUH-01139

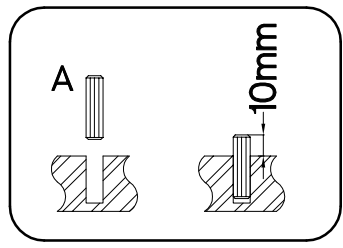
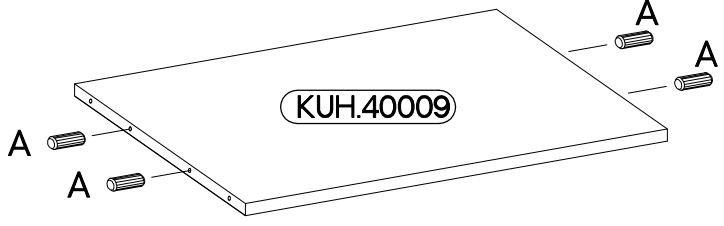
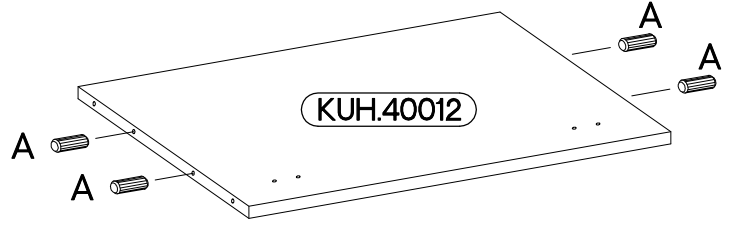
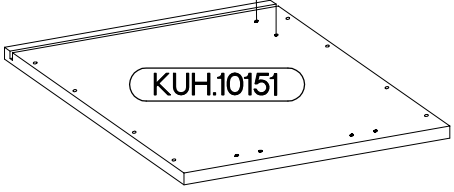
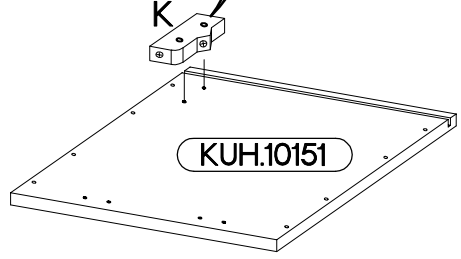
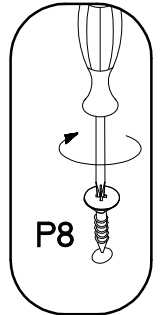
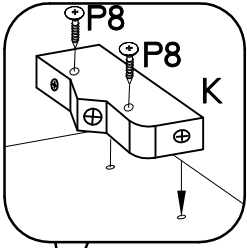
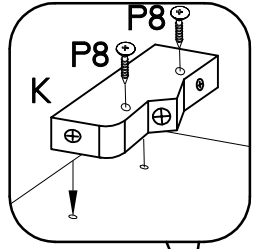
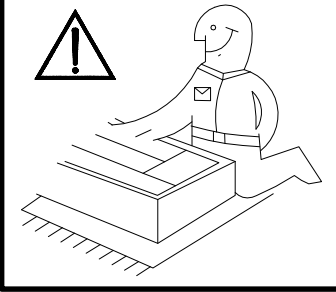

1

$\varnothing 8 \times 30 \text{mm}$	$\varnothing 4.0 \times 30 \text{mm}$	
		
A	P8	K
8	4	2

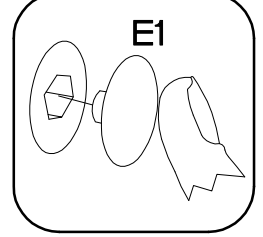
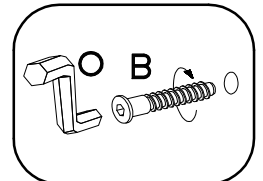
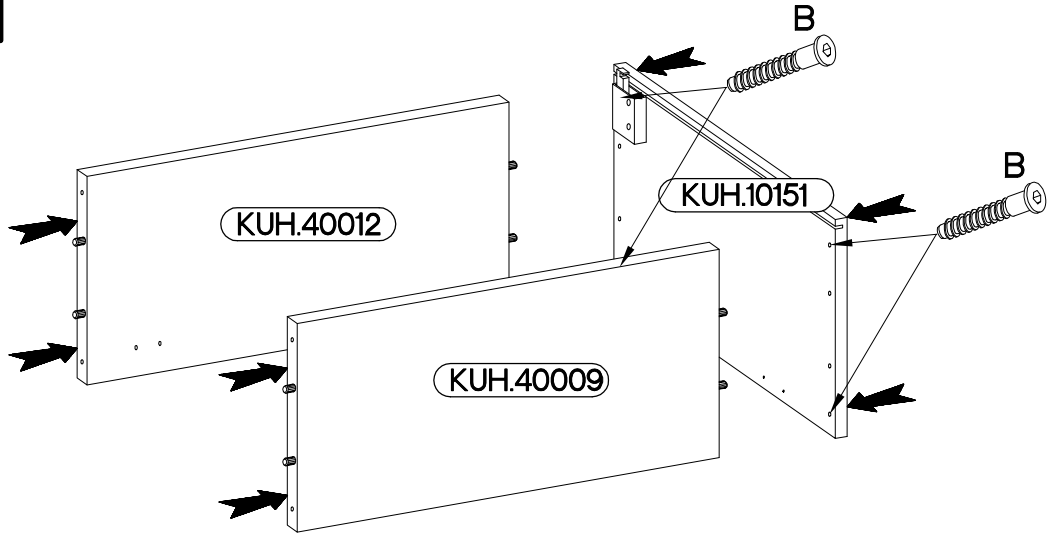

2

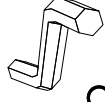

$6.4 \times 50 \text{mm}$		
		
B	O	E1
4	1	4

3

6,4 x 50mm

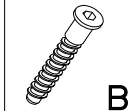

B

4

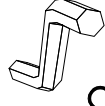

O

1



E1

4

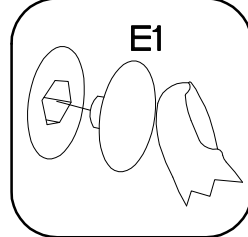
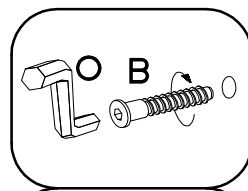
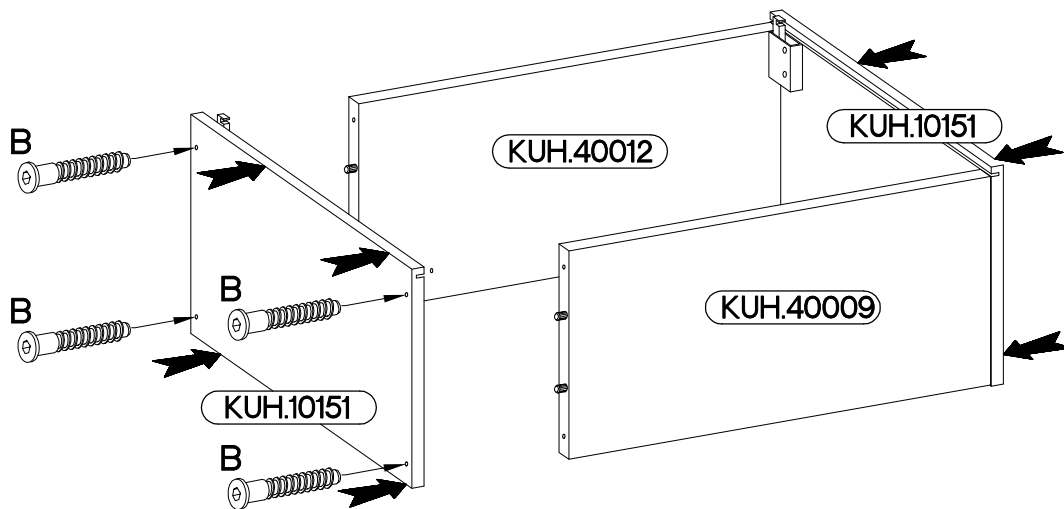
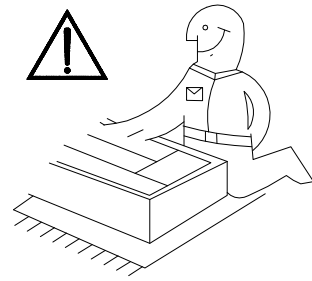

4

±3.0x20mm



P7

8-10

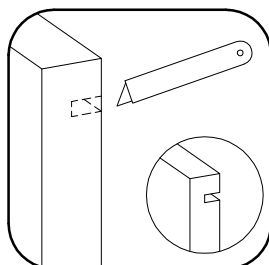
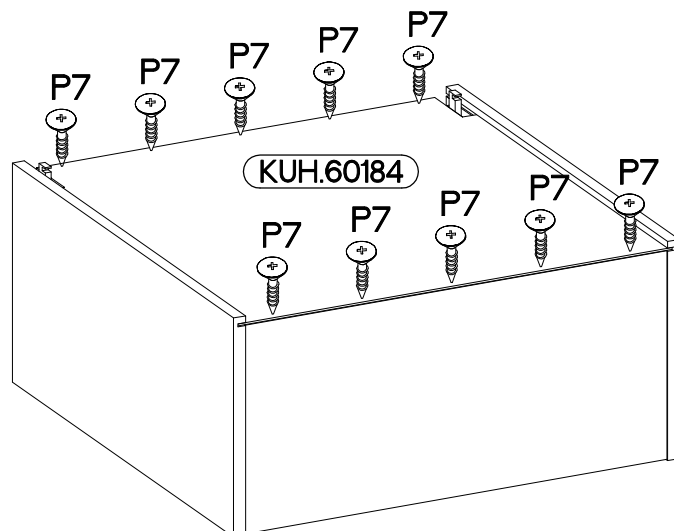
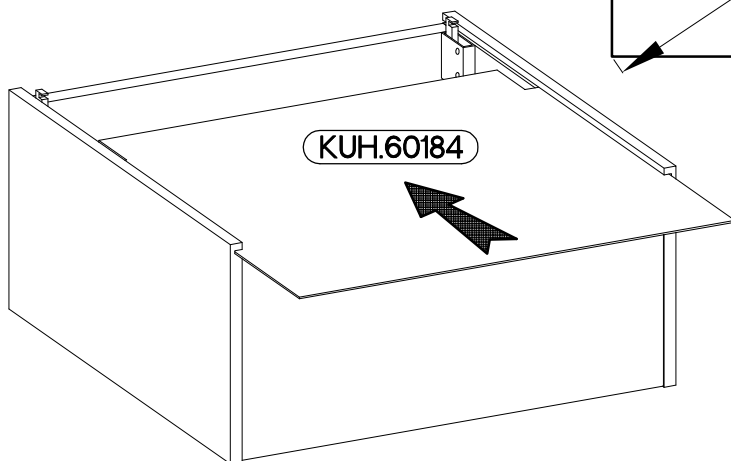
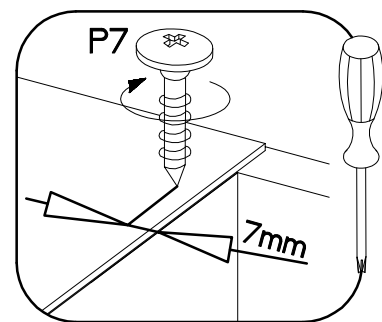
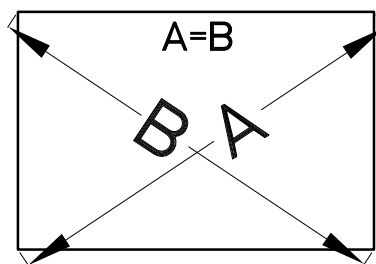

5

FRONT

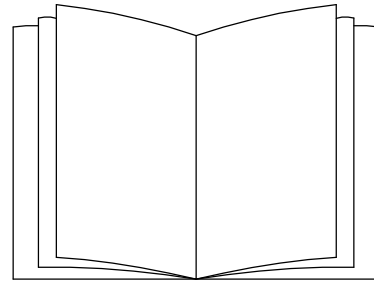
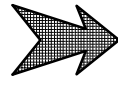
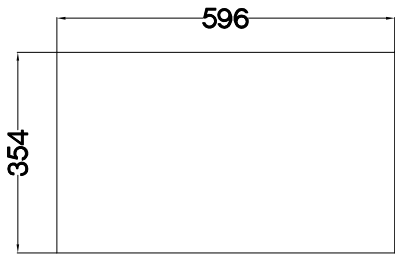

6

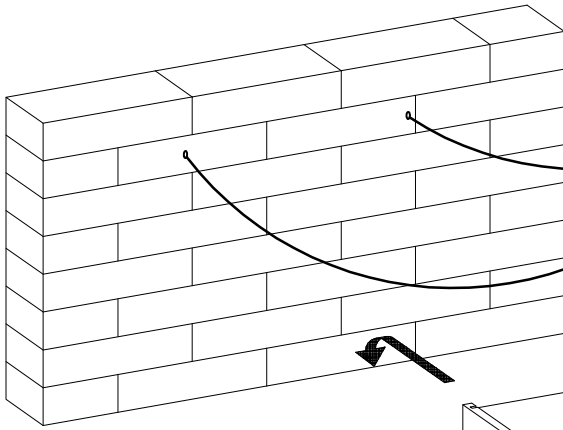

A

Ø10mm

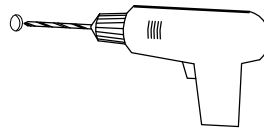

B

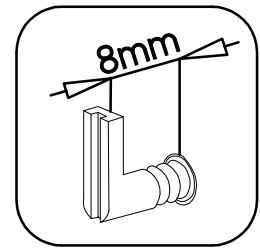
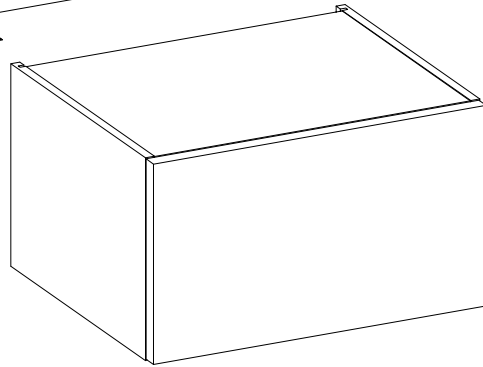
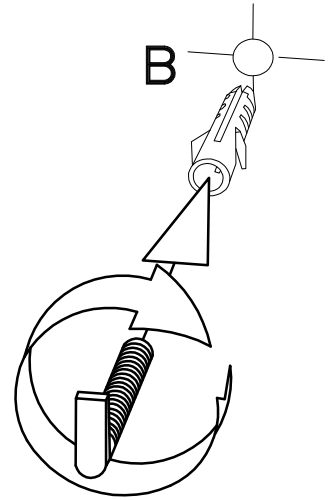

x2

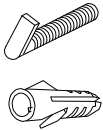

SHOP

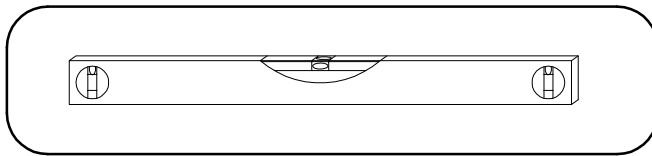
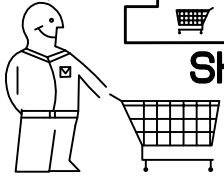

C

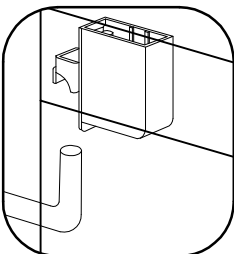

D

