

80 GS-72 2F

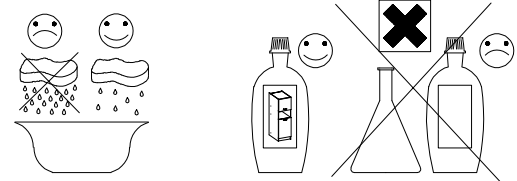

KUH.30011
KUH.40022

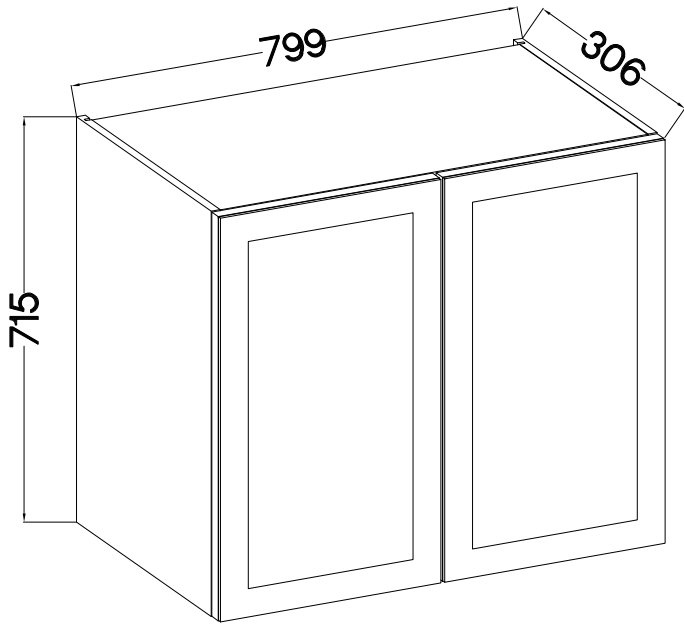

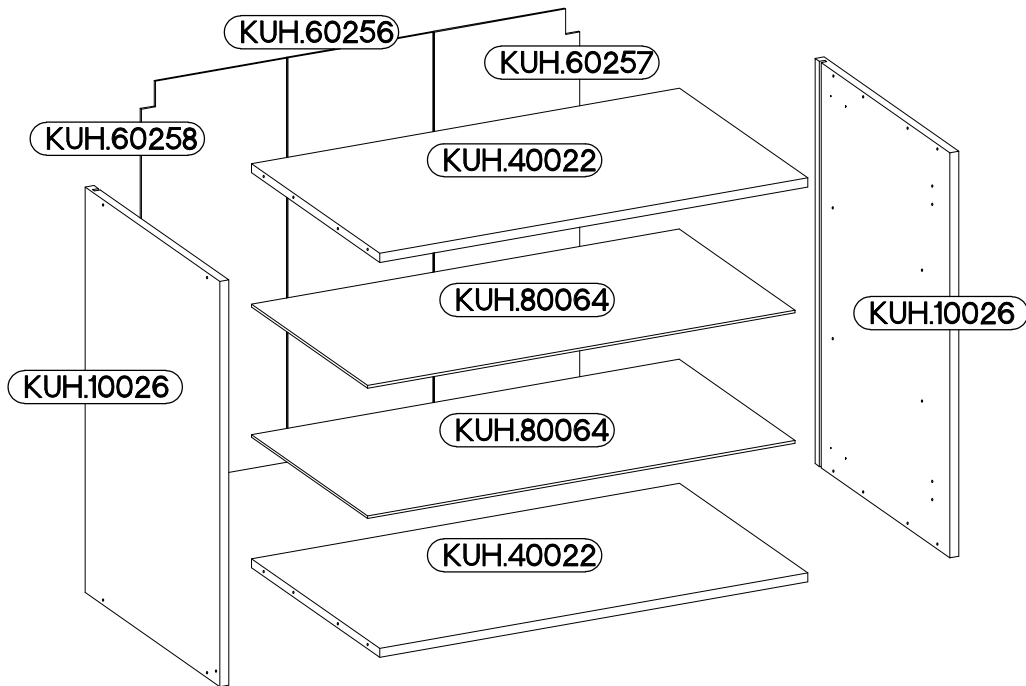
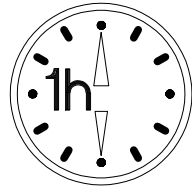

| Ersatzteil Nummer | Dimension |
|-------------------|-------------|
| KUH.10026 x2 | 715x290x16 |
| KUH.40022 x2 | 767x276x16 |
| KUH.60256 | 713x260x2,5 |
| KUH.60257 | 713x260x2,5 |
| KUH.60258 | 713x260x2,5 |
| KUH.80064 x2 | 766x250x5 |

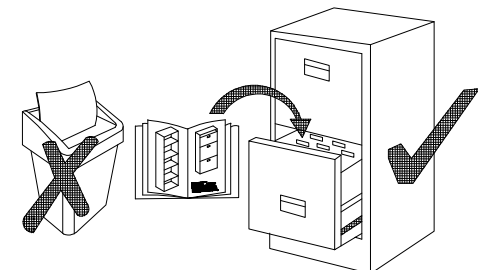
| | | | | | | | | | | |
|--------------------------|-----------------------------|---------|--------------------------------|----------------------------|---------------|----------------------------|---------------|-----------------------------|---------------------------------|-----------------------------|
| +8x30mm A 8 | 6,4 x 50mm B 8 | E1 8 | +35/0mm [CD] HG 4 | +5/16mm J12 8 | K 2 | L1=680mm L1 2 | O 1 | +3.5x13mm P5 8 | +3.0x20mm P7 15-20 | +4.0x30mm P8 4 |
|--------------------------|-----------------------------|---------|--------------------------------|----------------------------|---------------|----------------------------|---------------|-----------------------------|---------------------------------|-----------------------------|

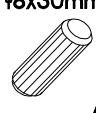

ISM-KUH-02004

1

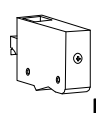
| | | |
|--|---|---|
|  ‡8x30mm A |  ‡4.0x30mm P8 |  K |
| 8 | 4 | 2 |

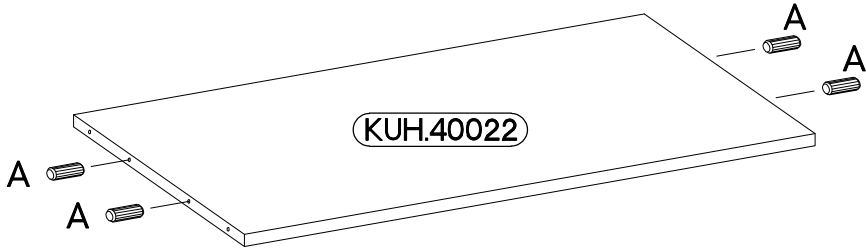
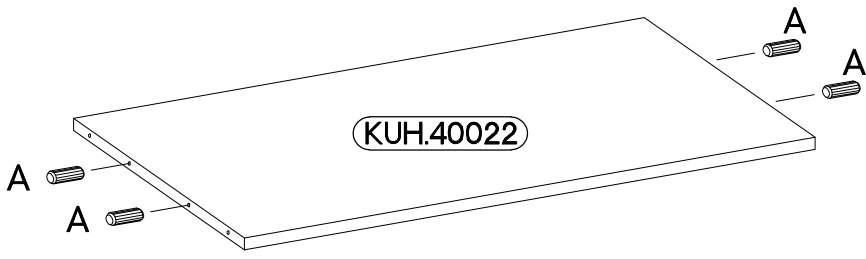
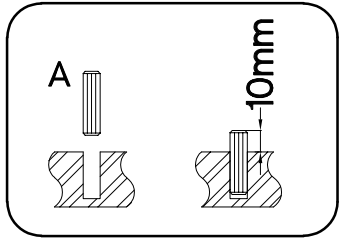
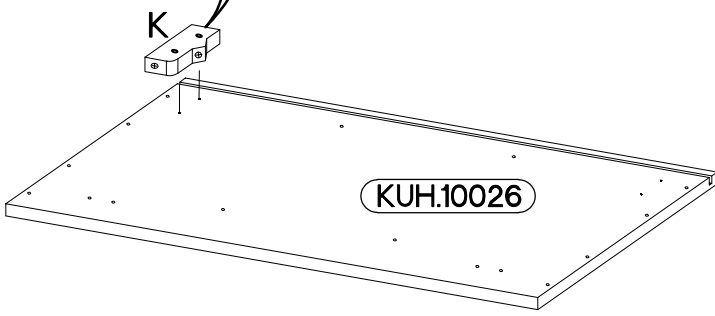
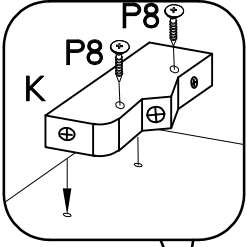
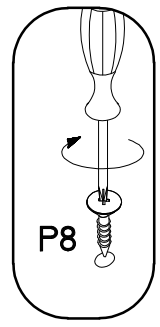
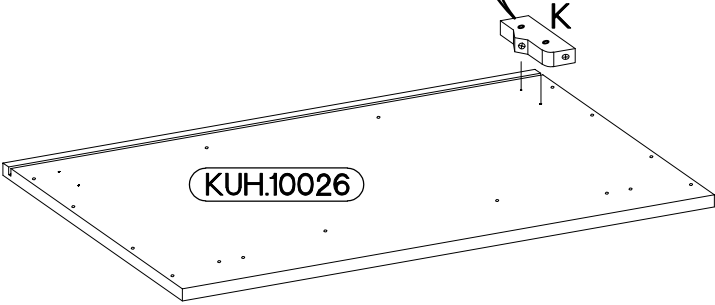
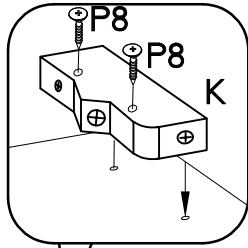
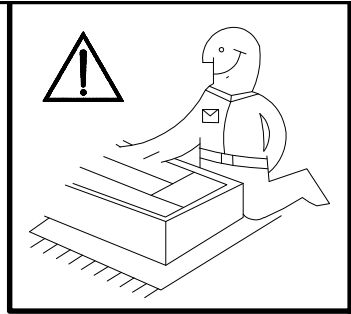

2

6,4 x 50mm

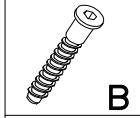

B

4

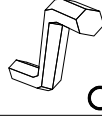

O

1



E1

4

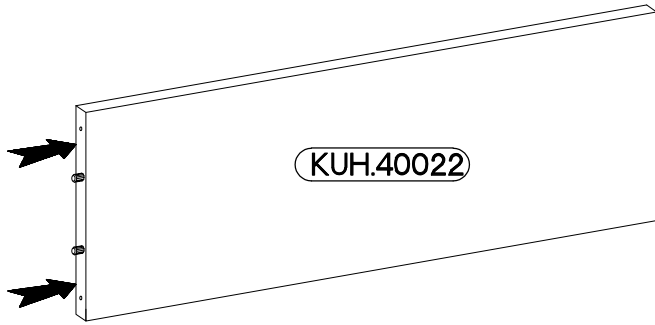
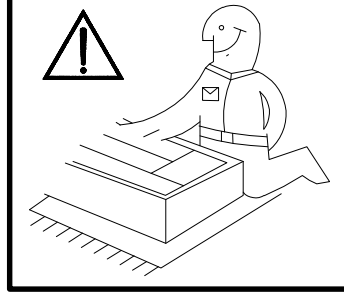

KUH.40022

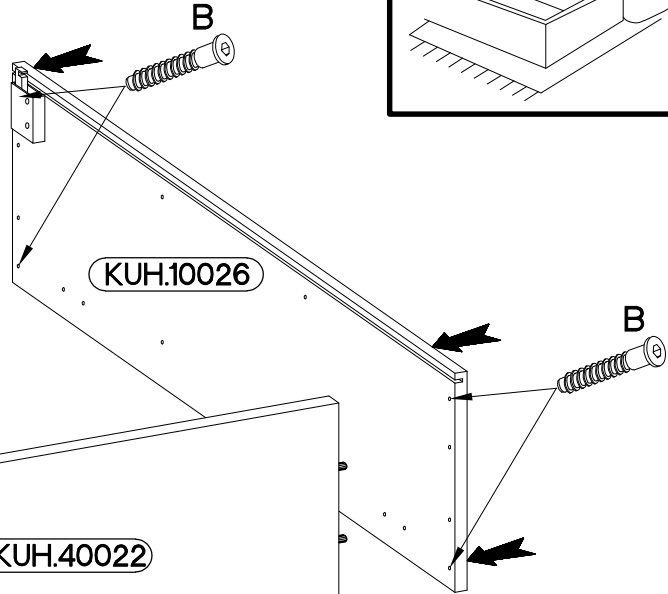

KUH.10026

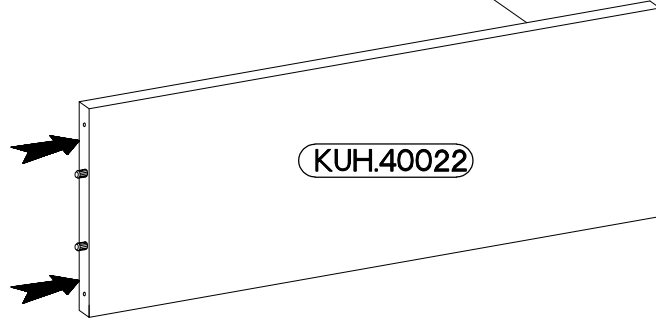

KUH.40022

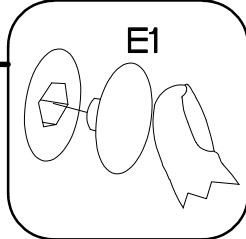
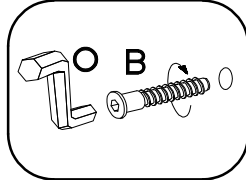

3

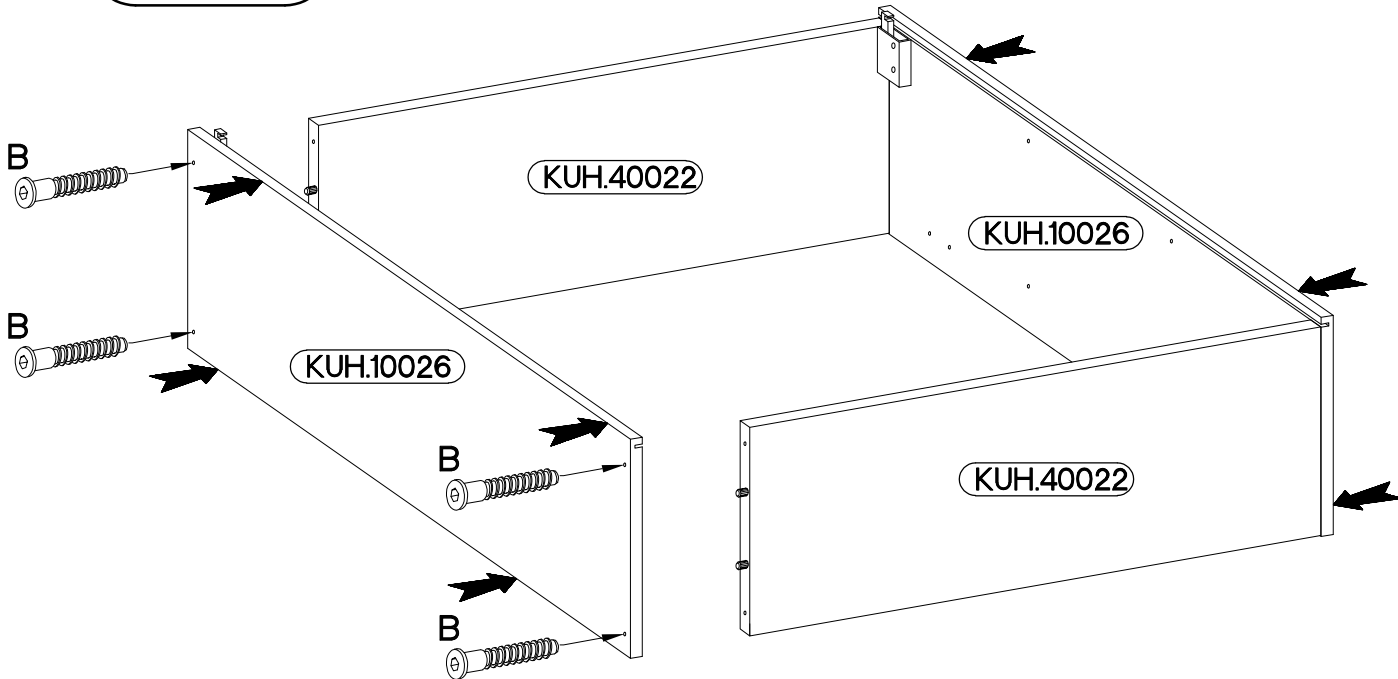

KUH.40022

KUH.10026

KUH.10026

KUH.40022

6,4 x 50mm

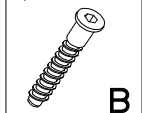

B

4

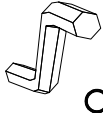

O

1



E1

4

4

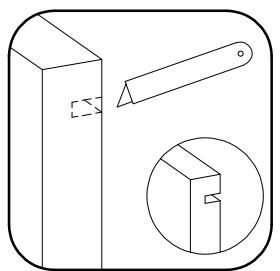
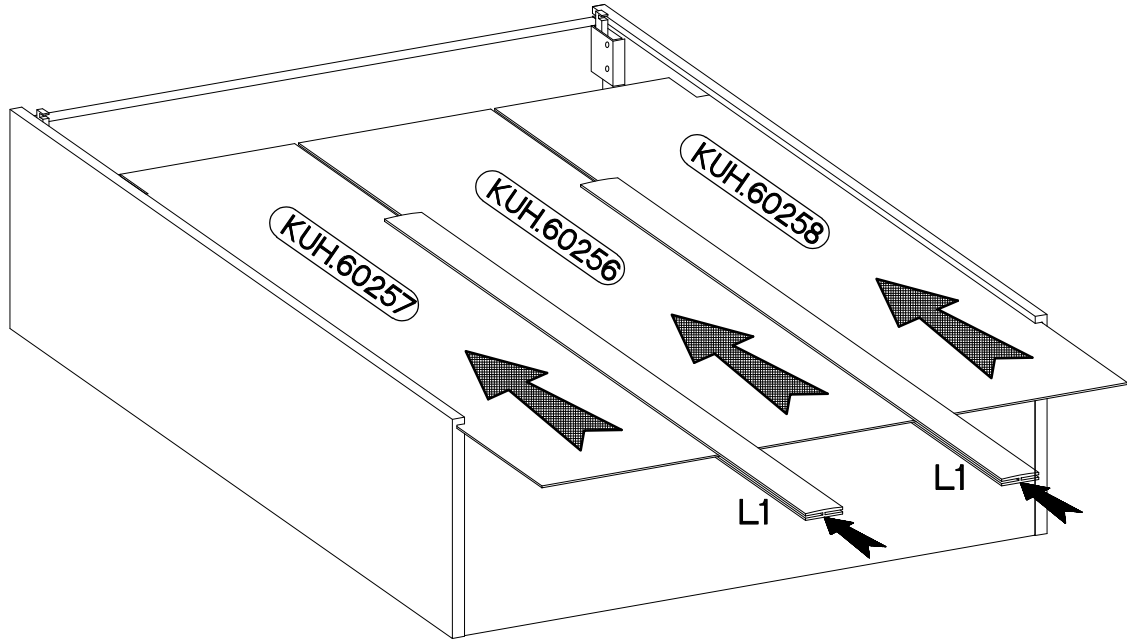
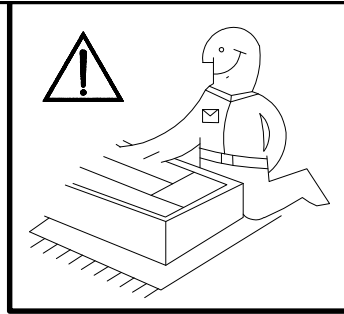
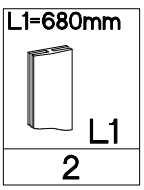

5

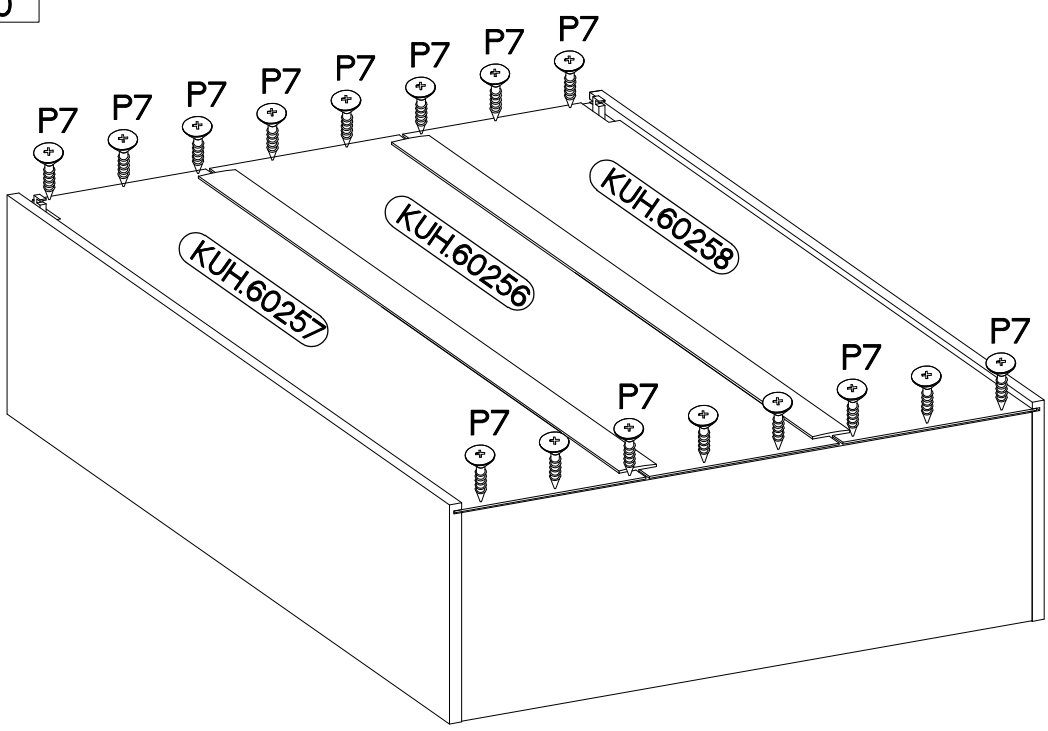
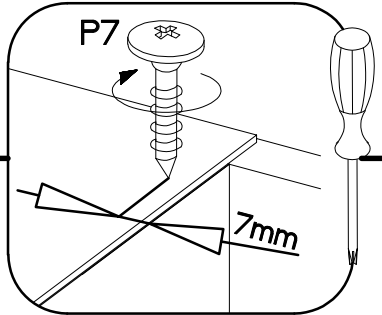
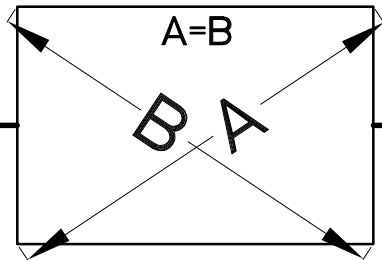
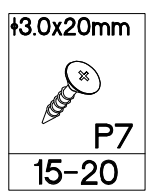

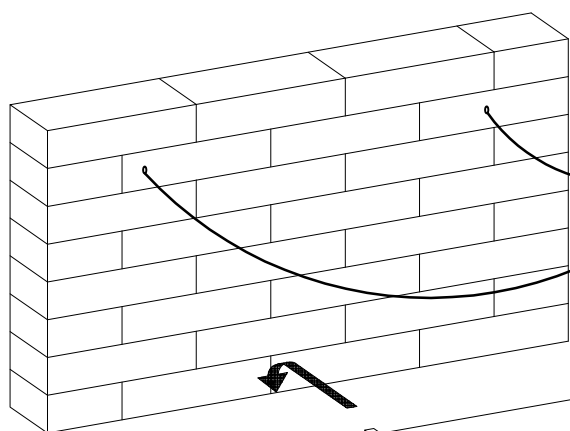
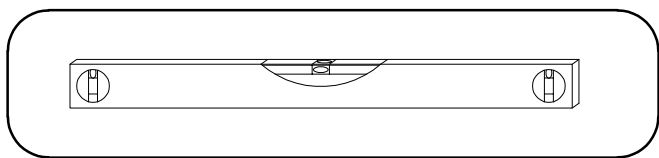

A

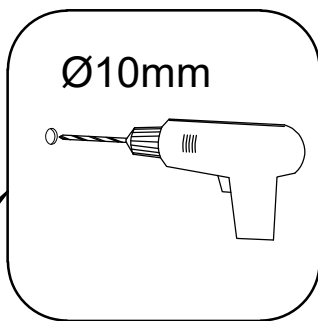

Ø10mm

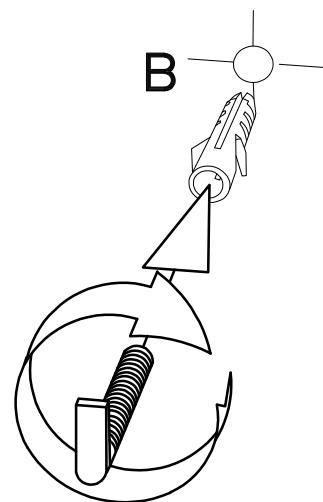
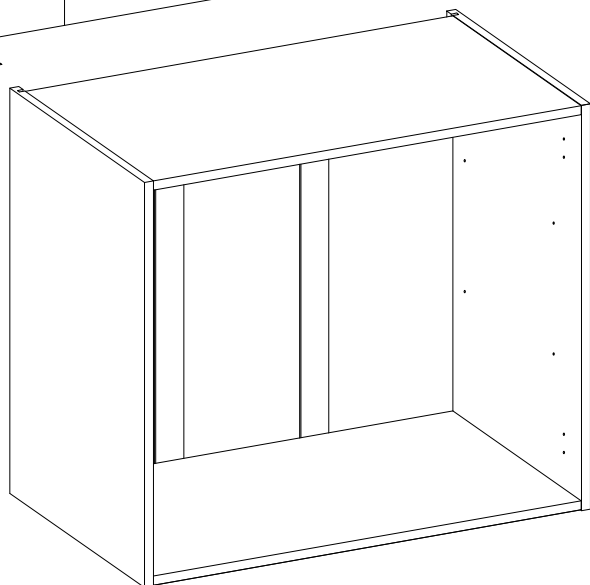

B

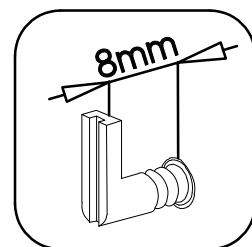

8mm

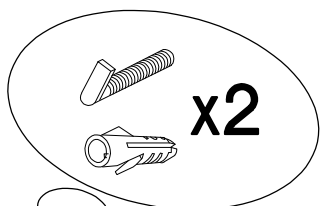

x2



SHOP

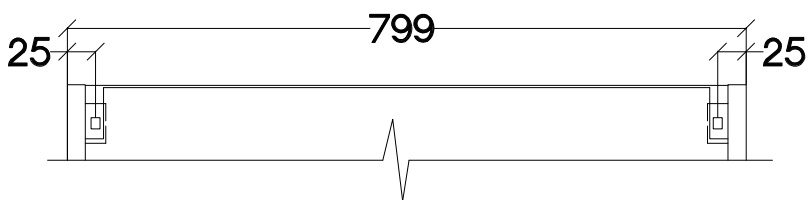

C

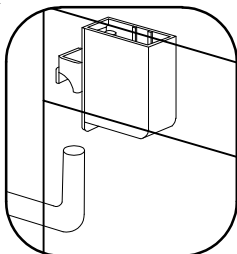

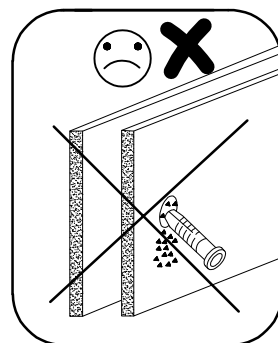
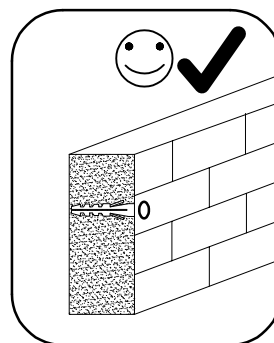
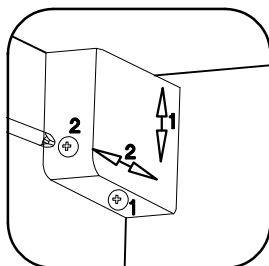

D

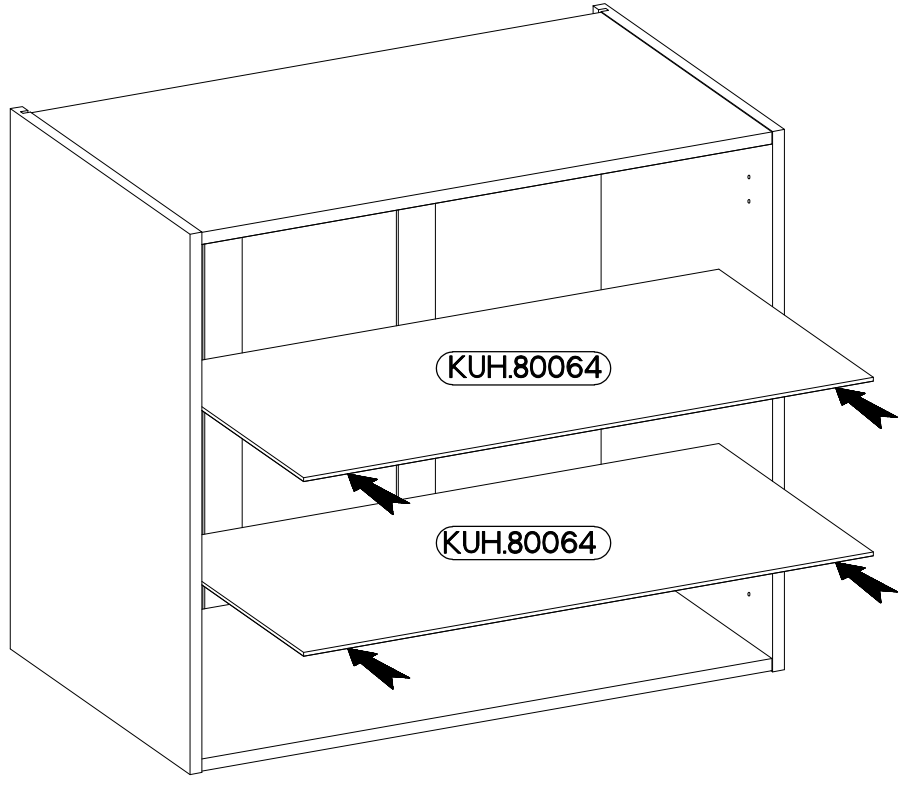
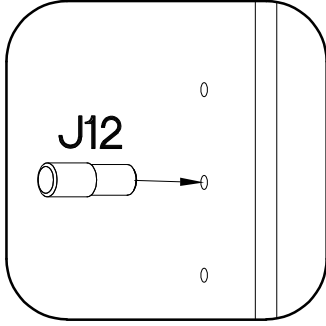

7

±5/16mm
J12
8



8

FRONT

