

# KAJA TYP 601

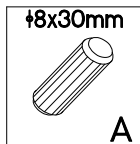

**44**

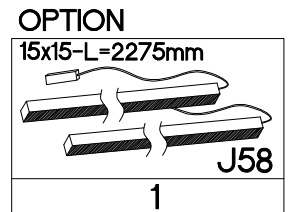
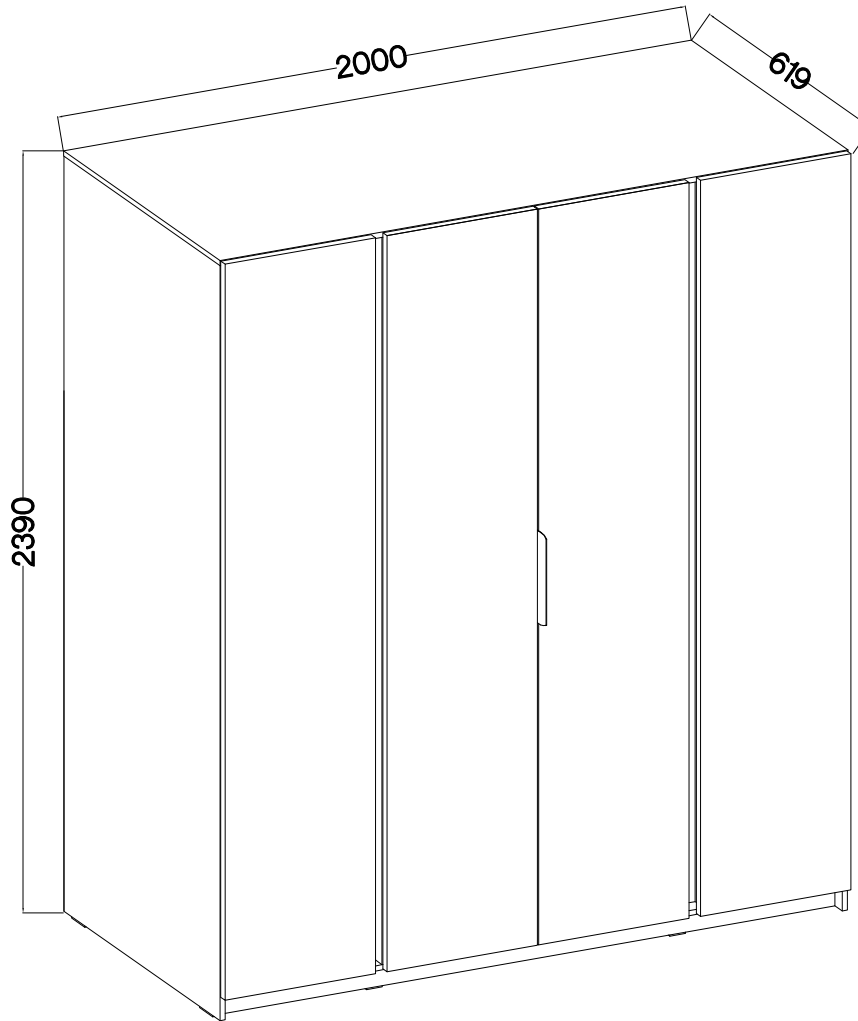
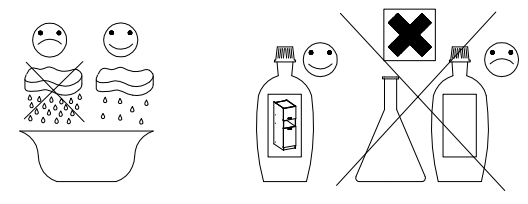
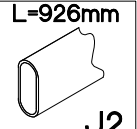
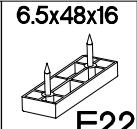
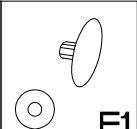
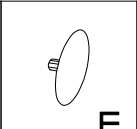
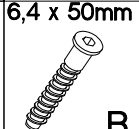
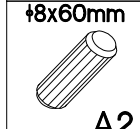

**4**

**4**

**20**

**54**

**42**

**6**

**48**

**24**

**8**

**16**

**1**

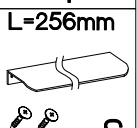
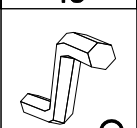
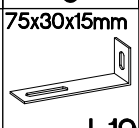
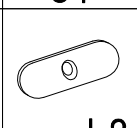
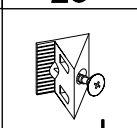
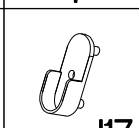
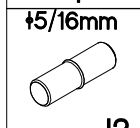

**24**

**2**

**22**

**24**

**55**

**2**

**1**

**2**



**38**

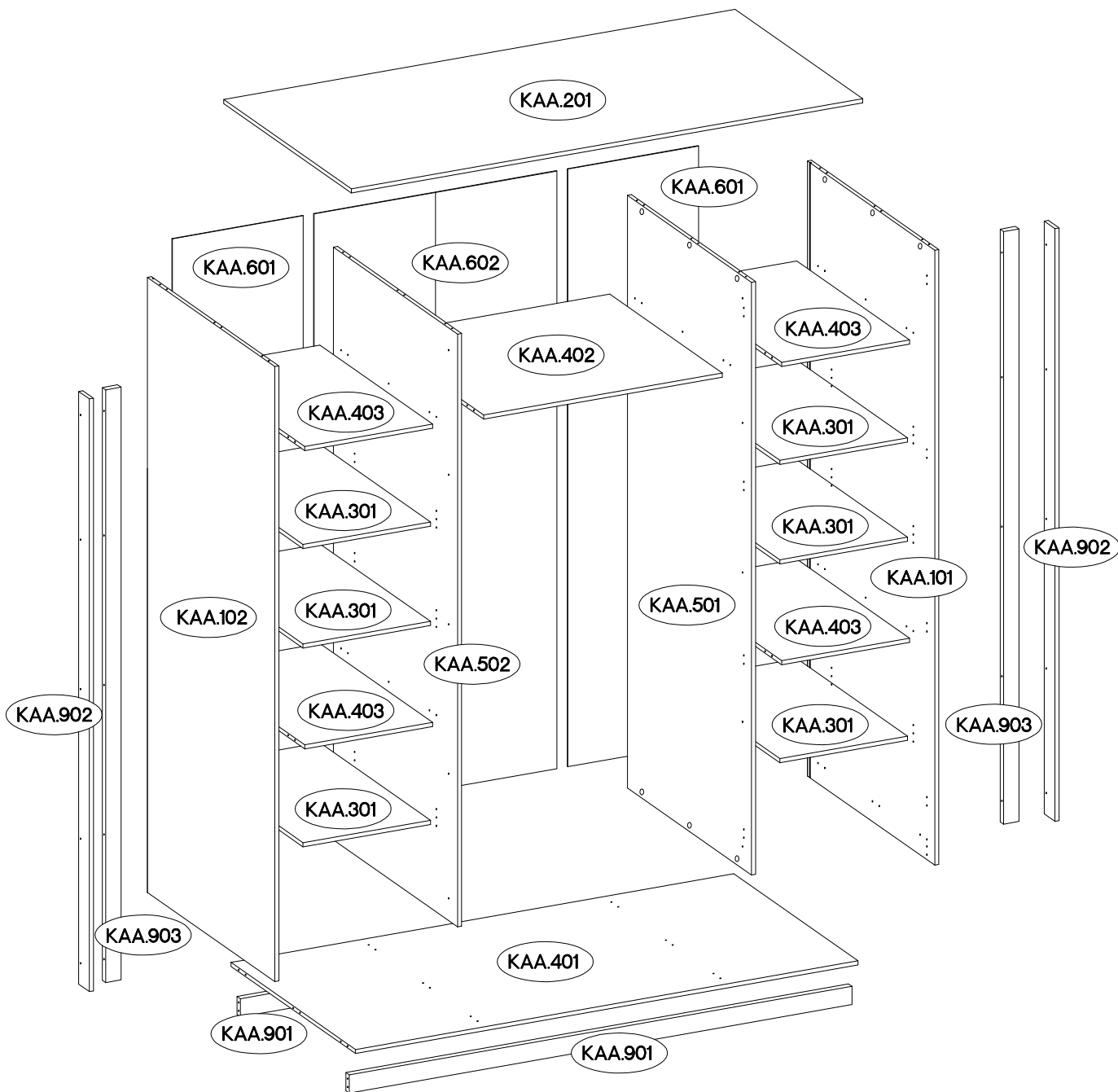

**2**

**1**

**ISM-KAA-001**



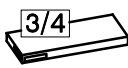

	Ersatzteil Nummer	Dimension
	KAA.402	934x530x16
	KAA.301 x6	499x520x16
	KAA.501	2283x584x16
	KAA.502	2283x584x16
	KAA.901 x2	1966x70x16
	KAA.902 x2	2283x50x16
	KAA.903 x2	2283x60x12

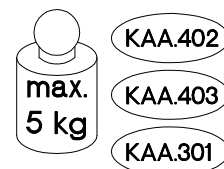
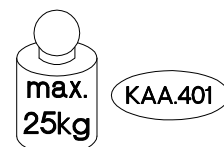
	Ersatzteil Nummer	Dimension
	KAA.101	2369x599x16
	KAA.102	2369x599x16
	KAA.601 x2	2302x512x2,5
	KAA.602	2302x949x2,5
	KAA.201	2000x600x16
	KAA.401	1966x585x16
	KAA.403 x4	500x530x16

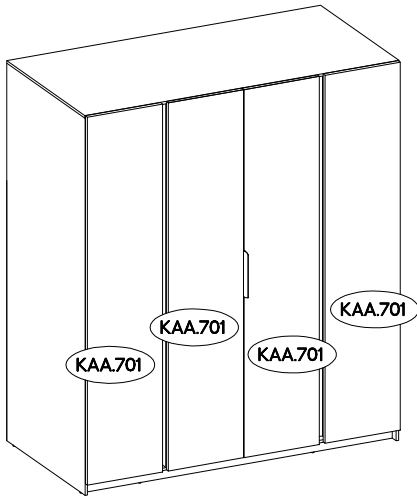

# OPTION



	Ersatzteil Nummer	Dimension
 x2	KAA.701 x4	2309x479x16

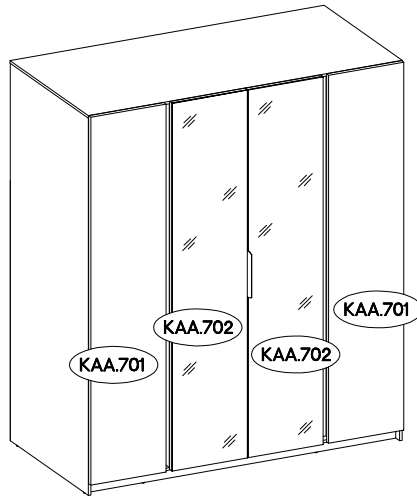

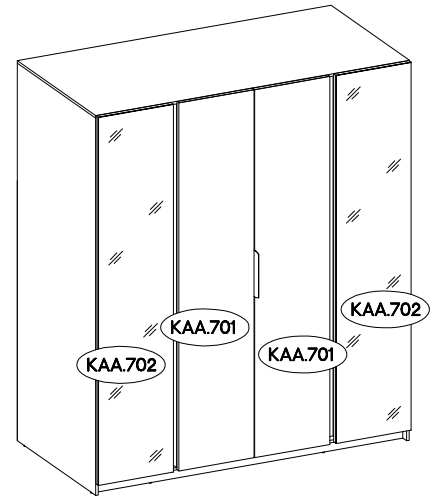

	Ersatzteil Nummer	Dimension
 x2	KAA.701 x2	2309x479x16
	KAA.702 x2	2309x479x19



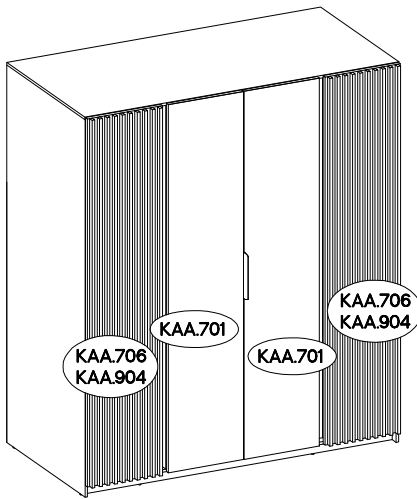

	Ersatzteil Nummer	Dimension
 x2	KAA.701 x2	2309x479x16
	KAA.702 x2	2309x479x19



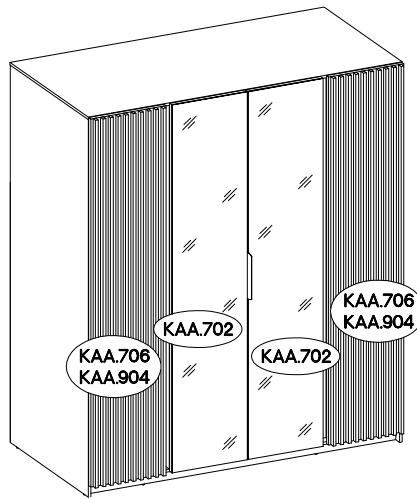

	Ersatzteil Nummer	Dimension
 x2	KAA.701 x2	2309x479x16
	KAA.706 x2	2309x479x16
	KAA.904 x20	2307x18x18
	 R1	4.0x27mm 82



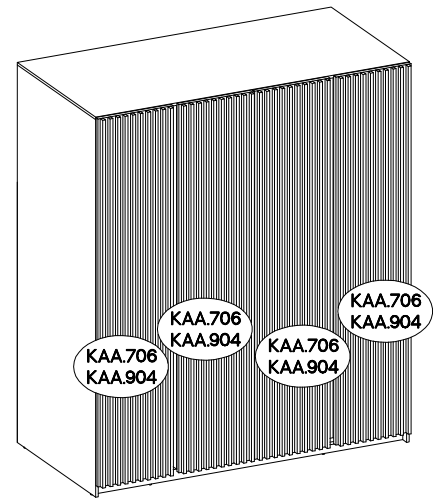

	Ersatzteil Nummer	Dimension
 x2	KAA.702 x2	2309x479x19
	KAA.706 x2	2309x479x16
	KAA.904 x20	2307x18x18
	 R1	4.0x27mm 82



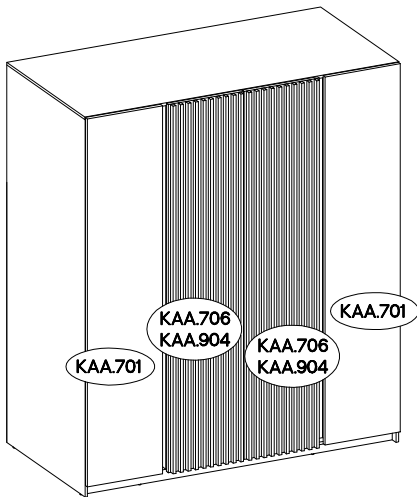

	Ersatzteil Nummer	Dimension
 x2	KAA.706 x4	2309x479x19
	KAA.904 x40	2307x18x18
	 R1	4.0x27mm 164

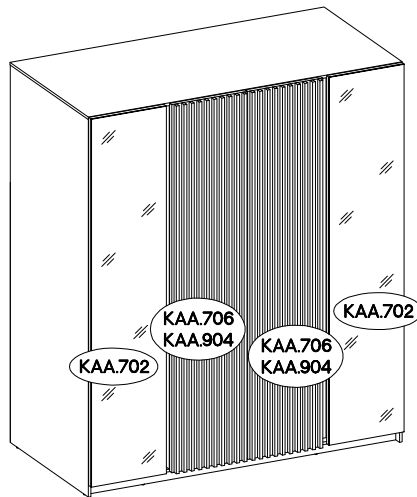

	Ersatzteil Nummer	Dimension
 x2	KAA.701 x2	2309x479x16
	KAA.706 x2	2309x479x16
	KAA.904 x20	2307x18x18
	 R1	4.0x27mm 82





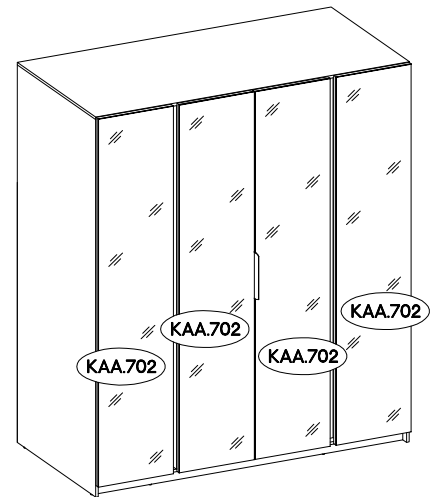

	Ersatzteil Nummer	Dimension
 x2	KAA.702 x2	2309x479x19
	KAA.706 x2	2309x479x16
	KAA.904 x20	2307x18x18
	 R1	4.0x27mm 82

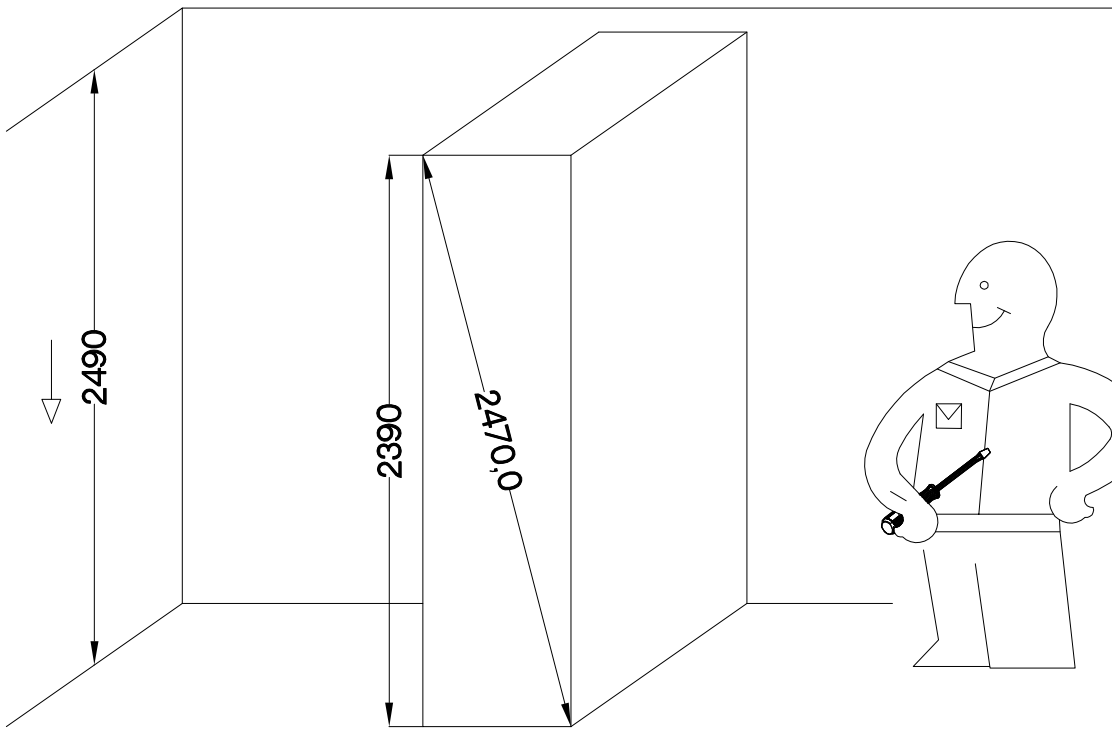
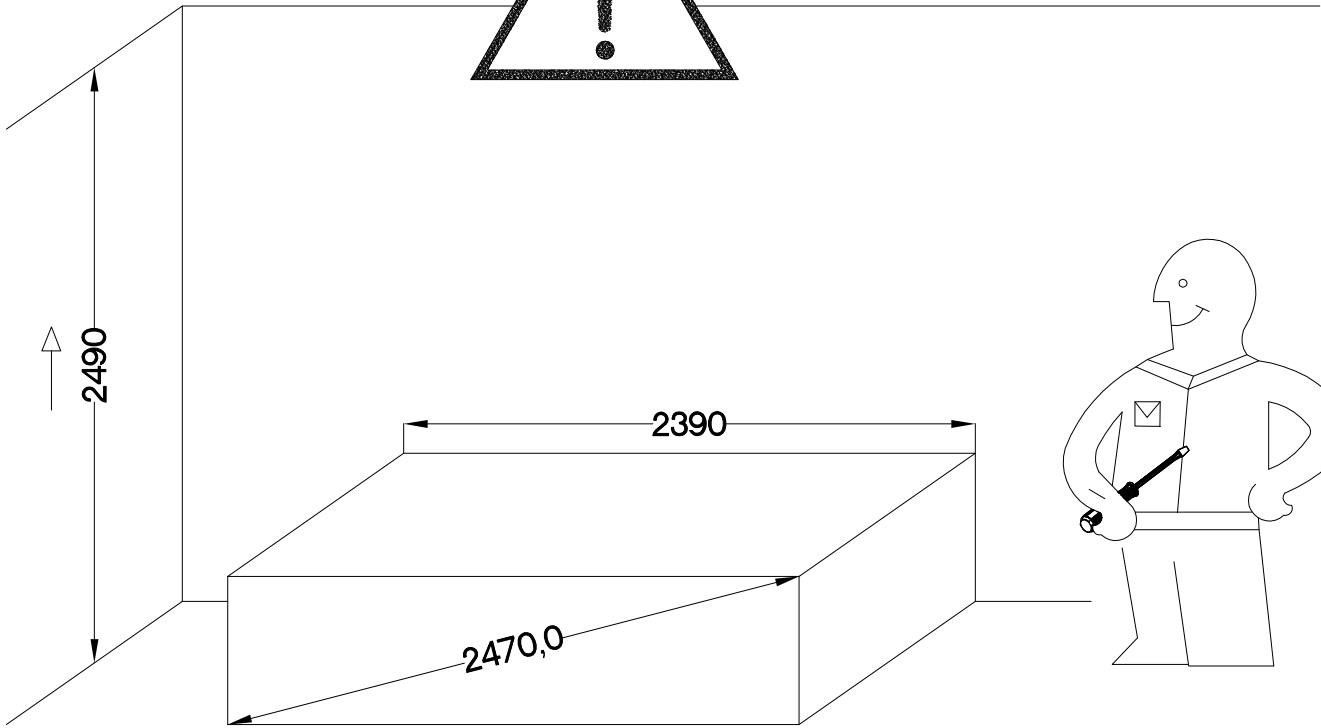
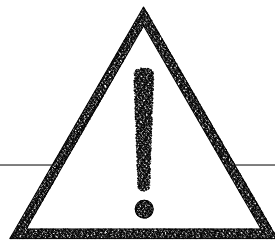

	Ersatzteil Nummer	Dimension
 x2	KAA.702x4	2309x479x19



1

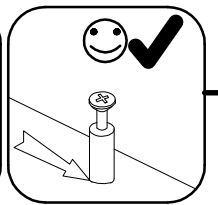
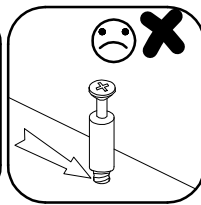
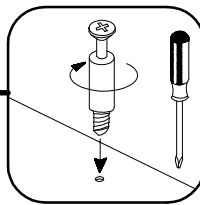
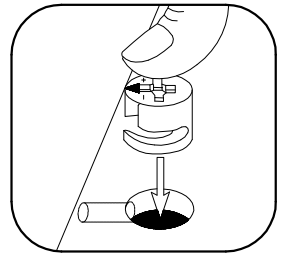
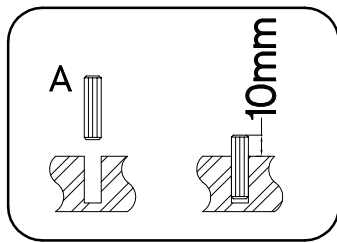
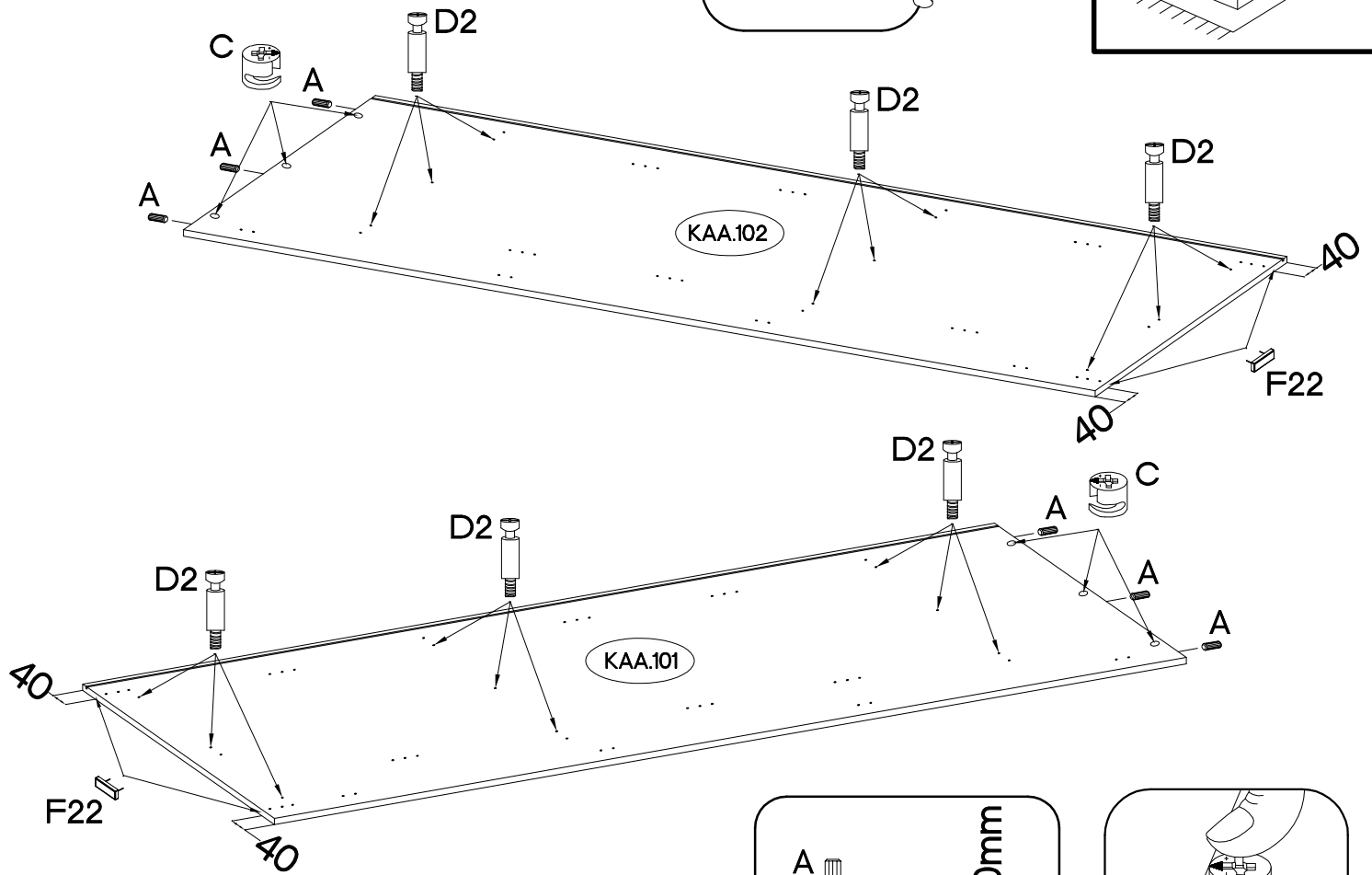
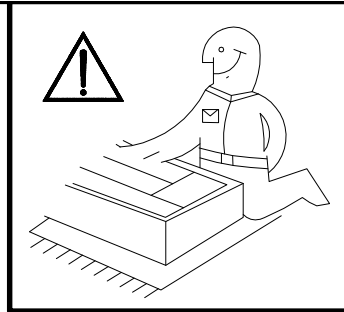
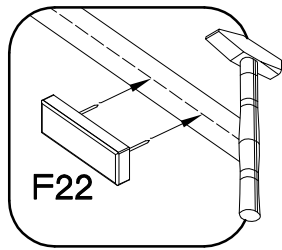

±8x30mm  A 6	±15/12mm  C 6	L=20mm  D2 18	6.5x48x16  F22 4
---	--	--	---





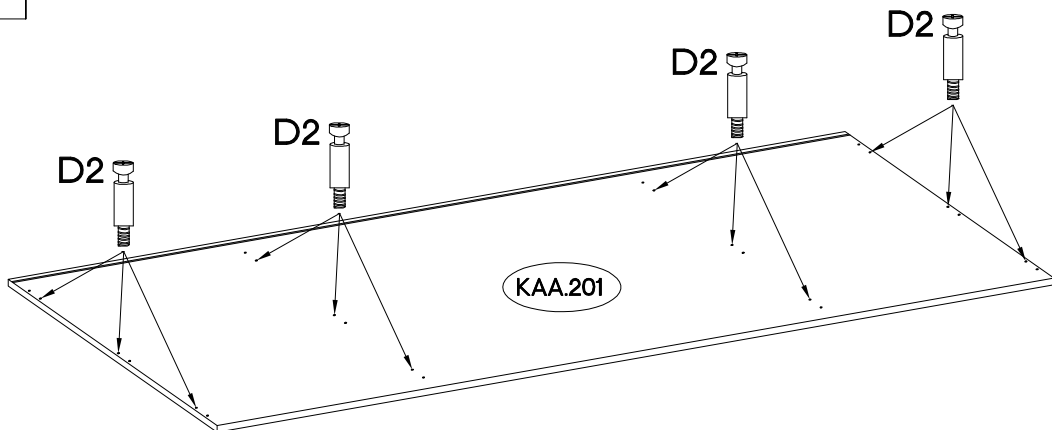

2

L=20mm  D2 12
---

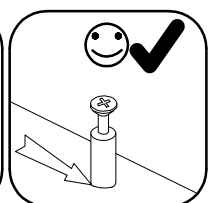
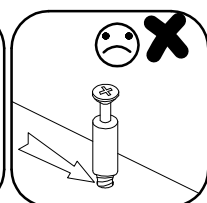
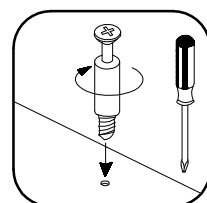
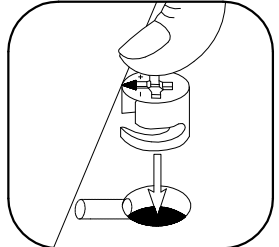
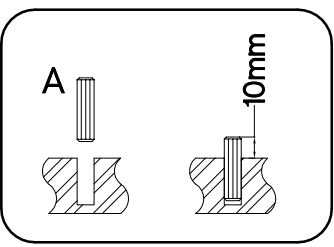
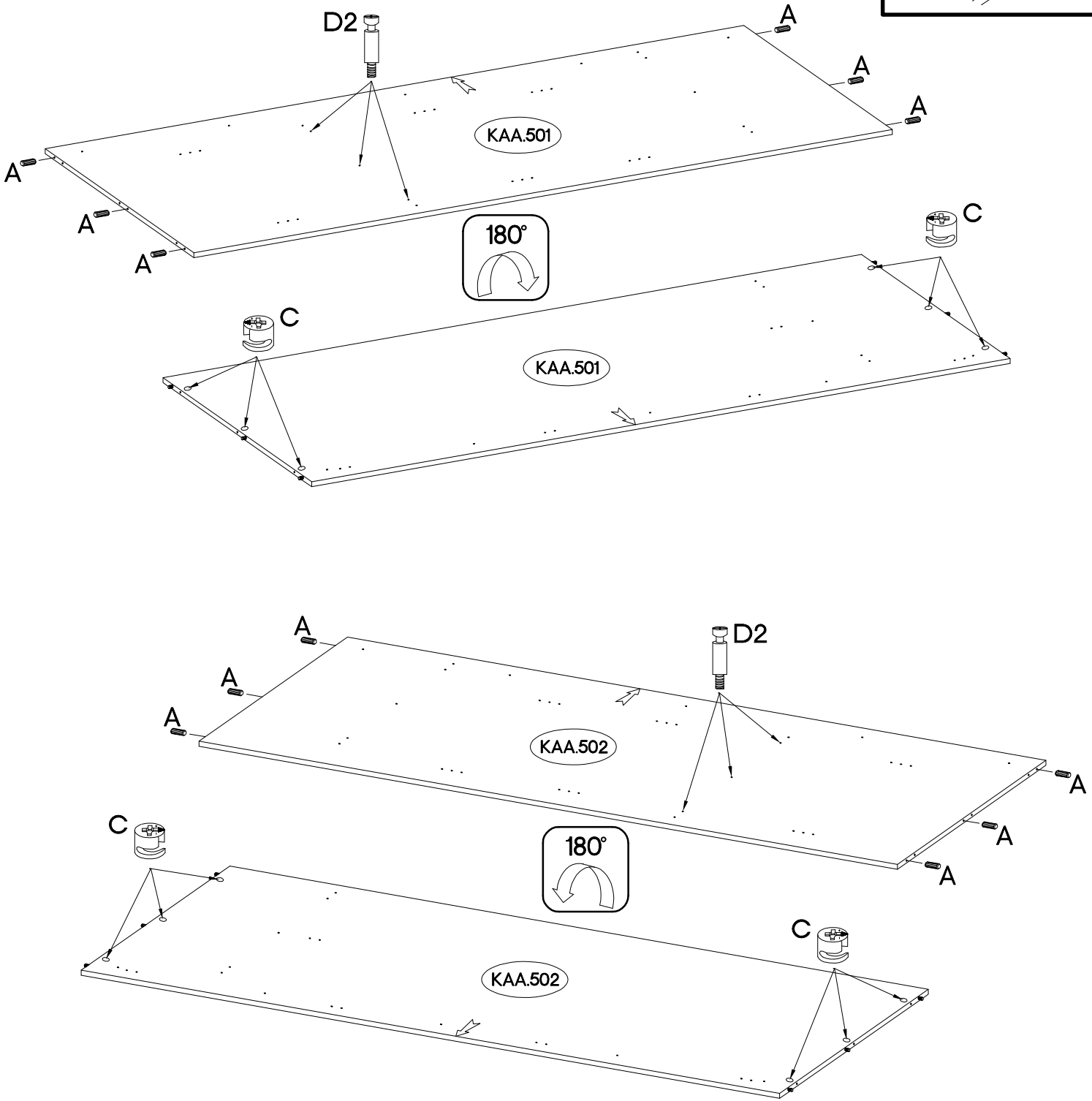
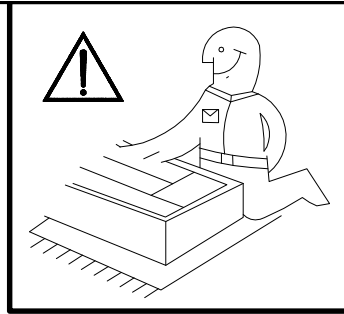



 <b>±8x30mm</b> <b>A</b>	 <b>±15/12mm</b> <b>C</b>	 <b>L=20mm</b> <b>D2</b>
12	12	6

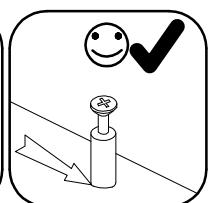
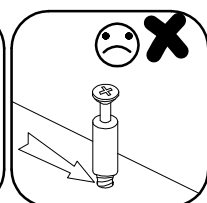
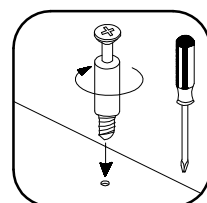
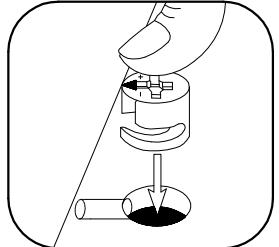
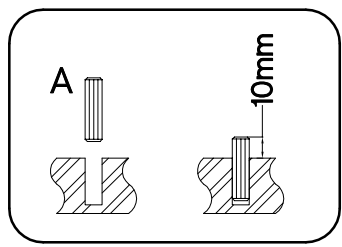
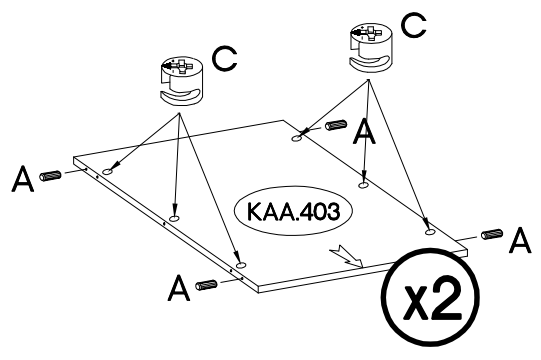
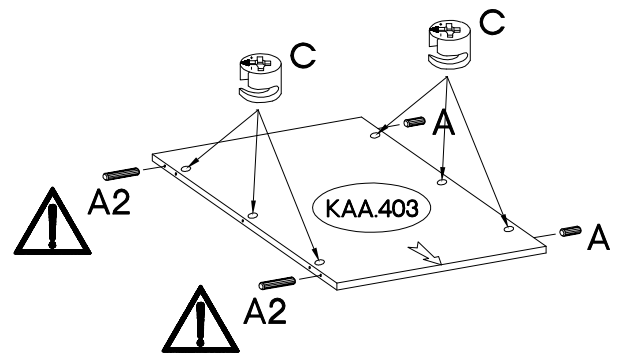
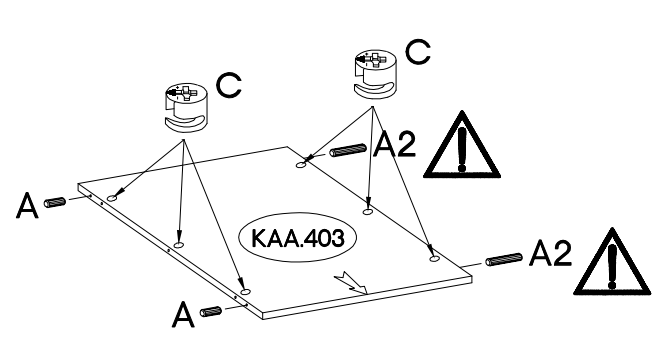
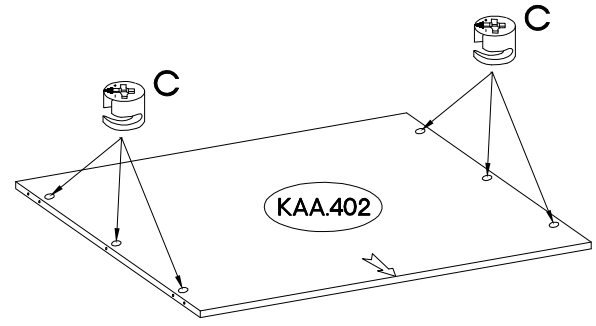
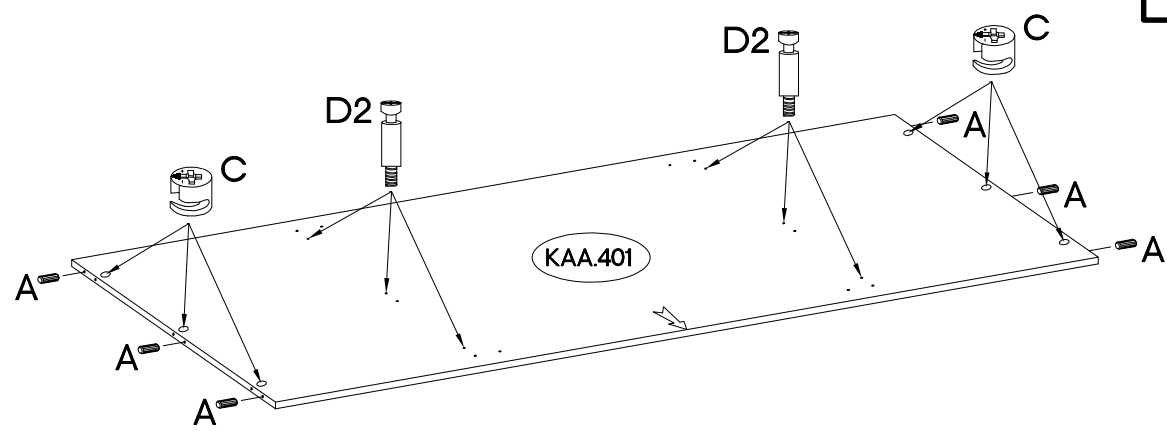
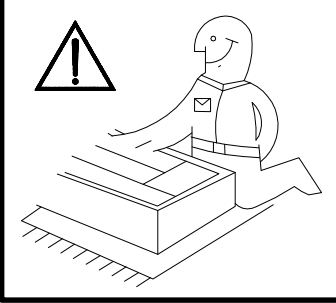

+8x30mm  A 18	+8x60mm  A2 4	+15/12mm  C 36	L=20mm  D2 6
--	--	---	---

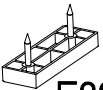

# 5

$\pm 8 \times 30 \text{mm}$  A	$6.5 \times 48 \times 16$  F22	$6.4 \times 35 \text{mm}$  B1	 O
8	4	10	1

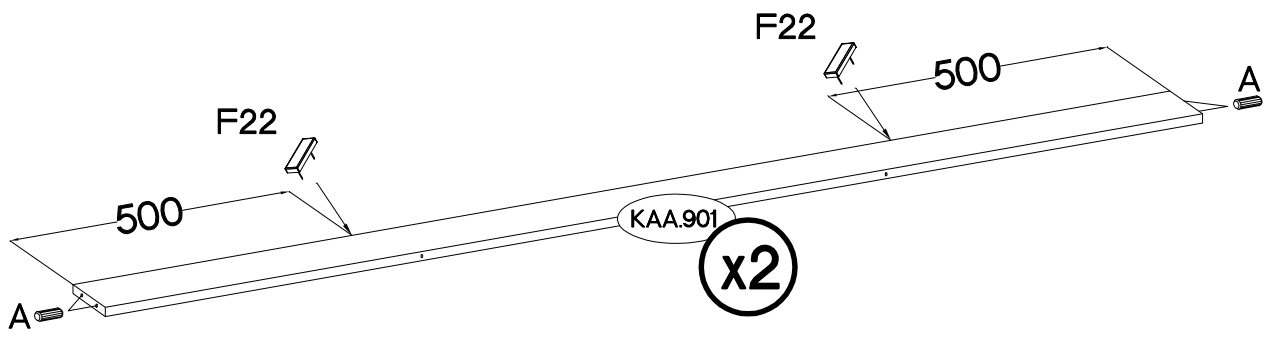
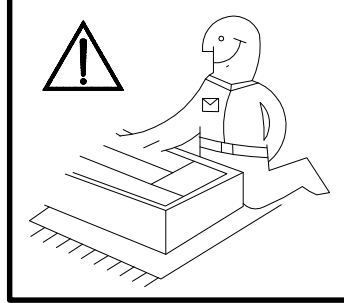

x2

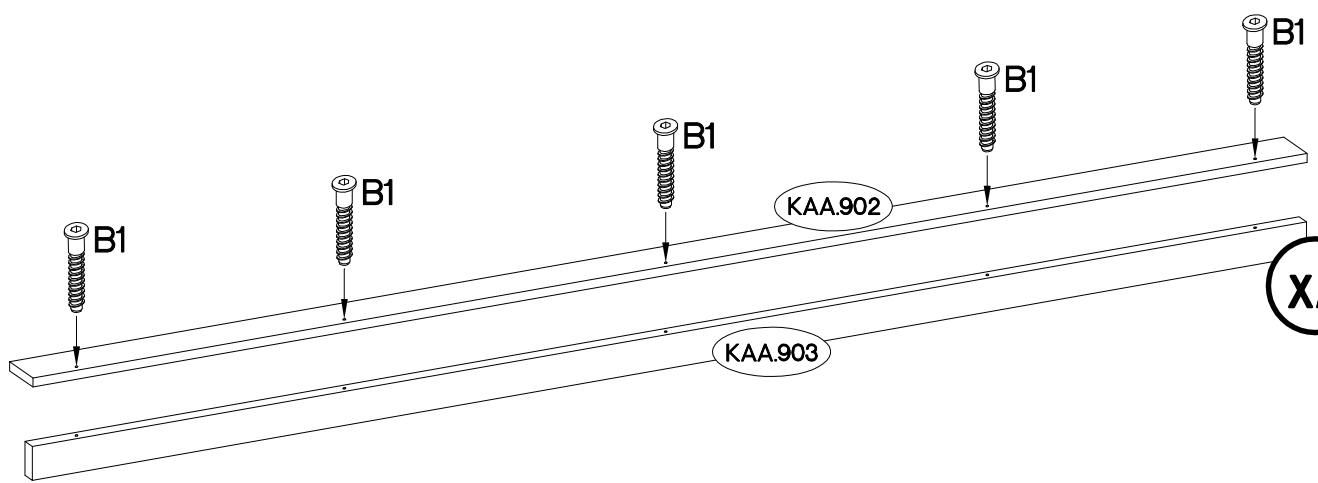

x2

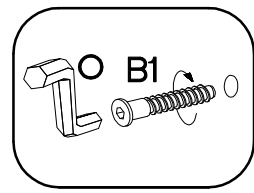
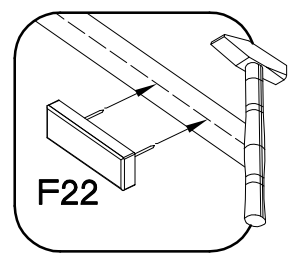
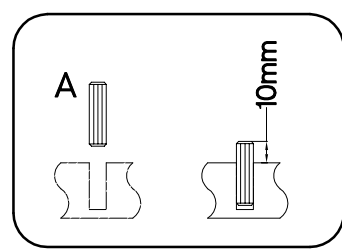
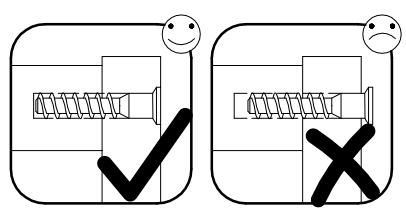



# 6

L=56mm

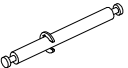

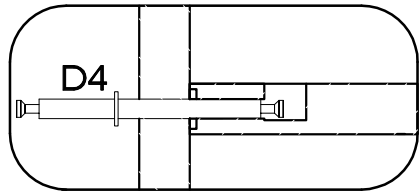
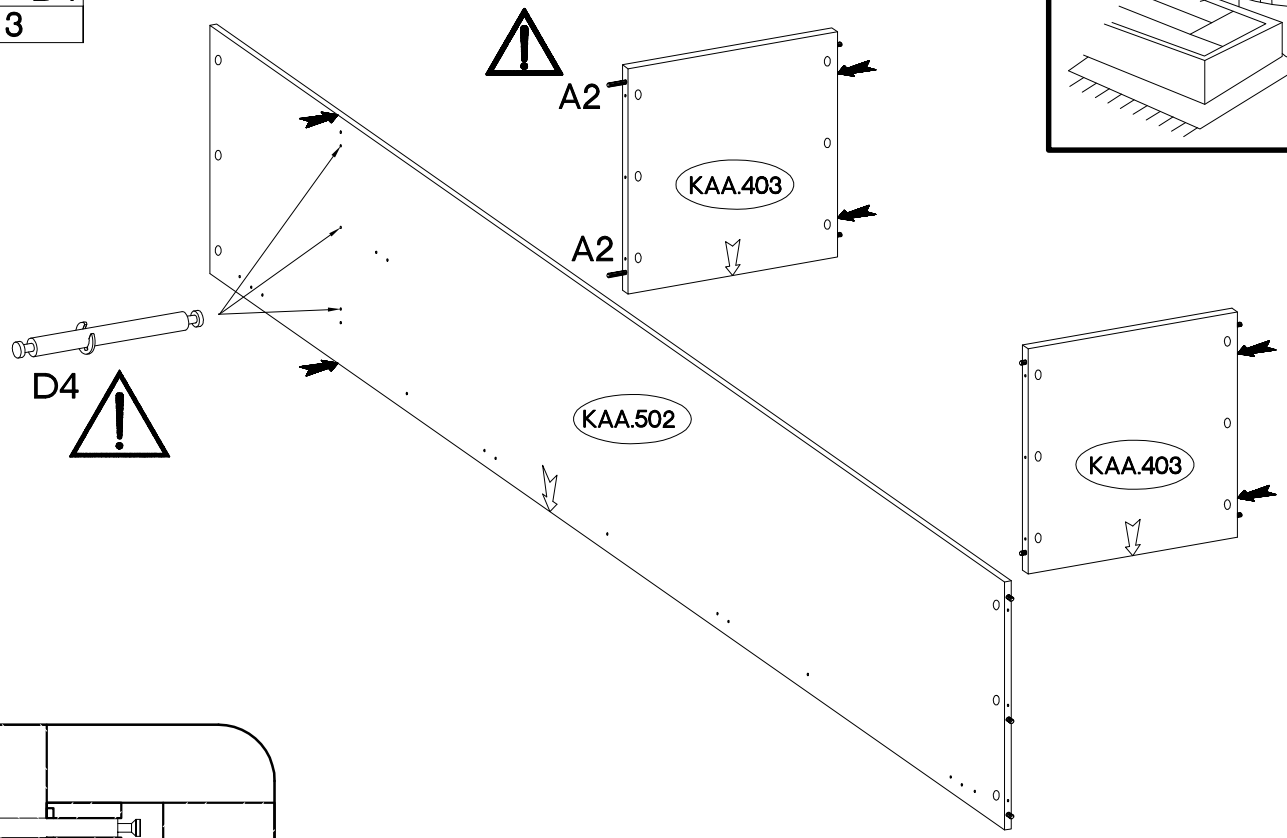
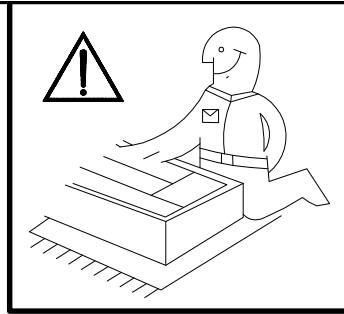

D4

3

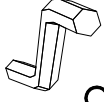

# 7

6,4 x 35mm			
	B1	O	E1
	5	1	10

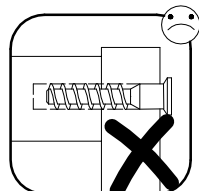
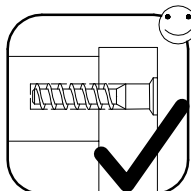
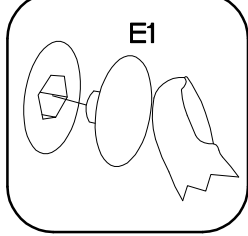
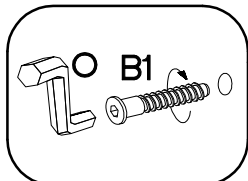
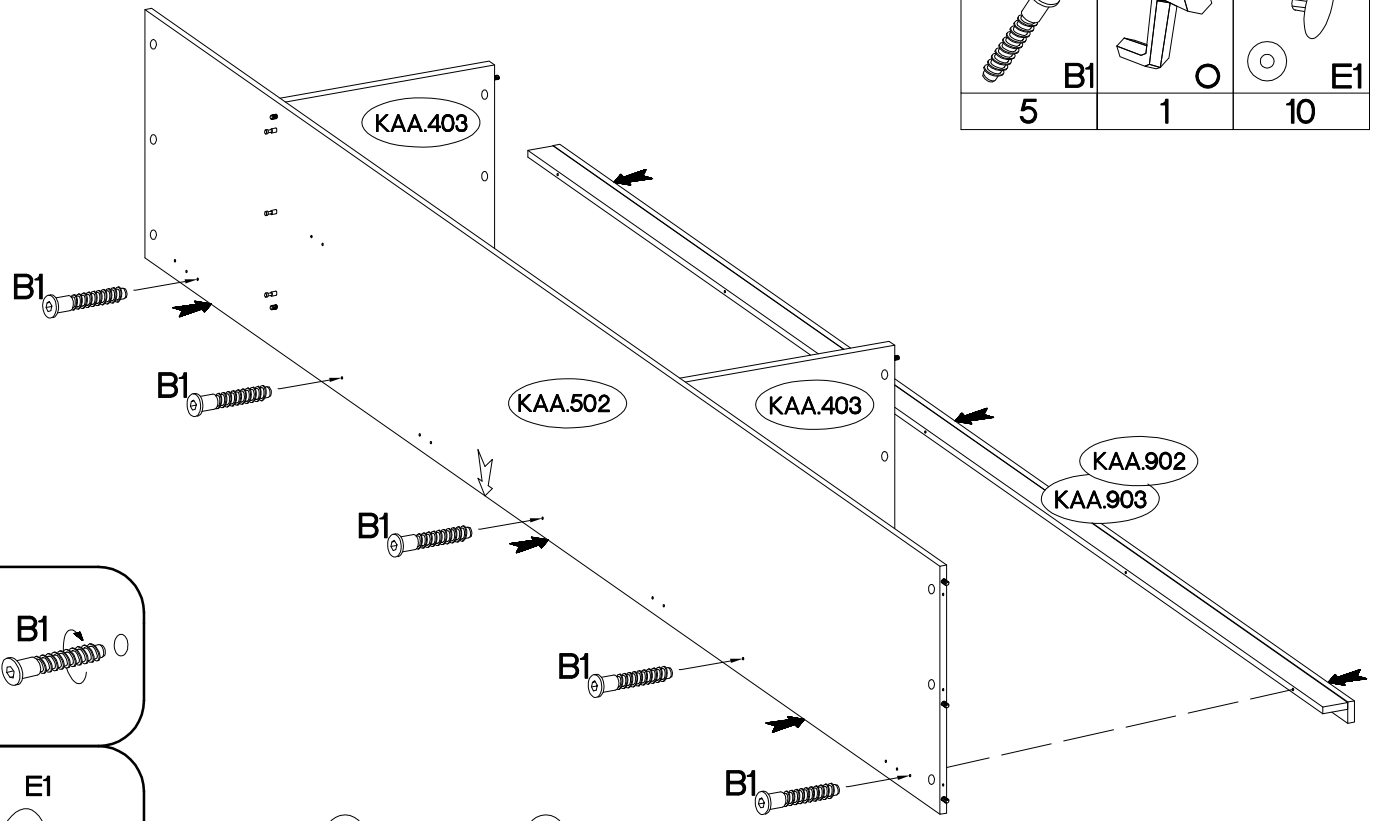

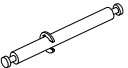

8

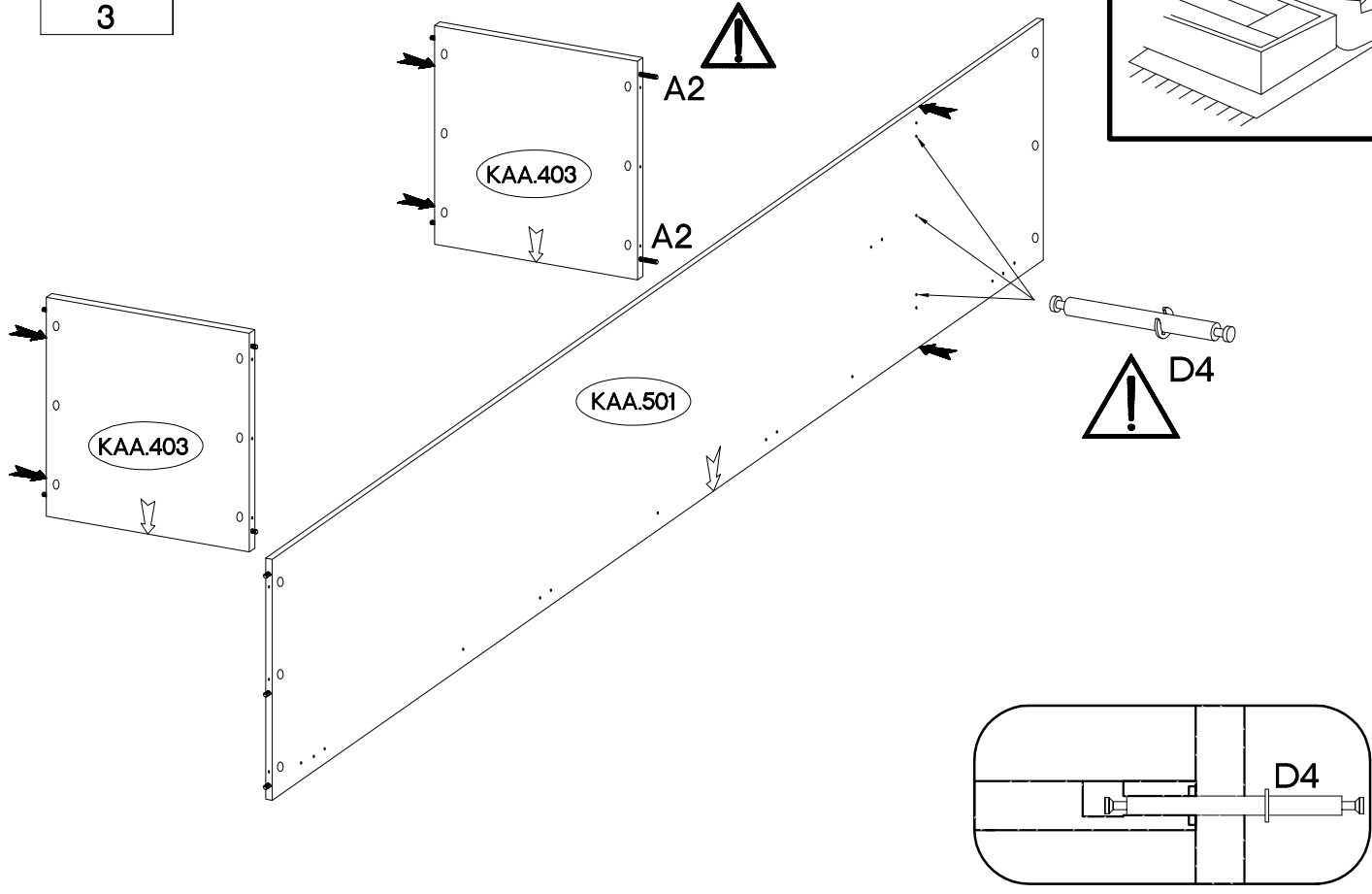
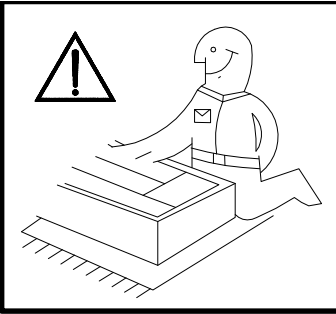
L=56mm

D4
3

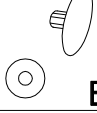

9

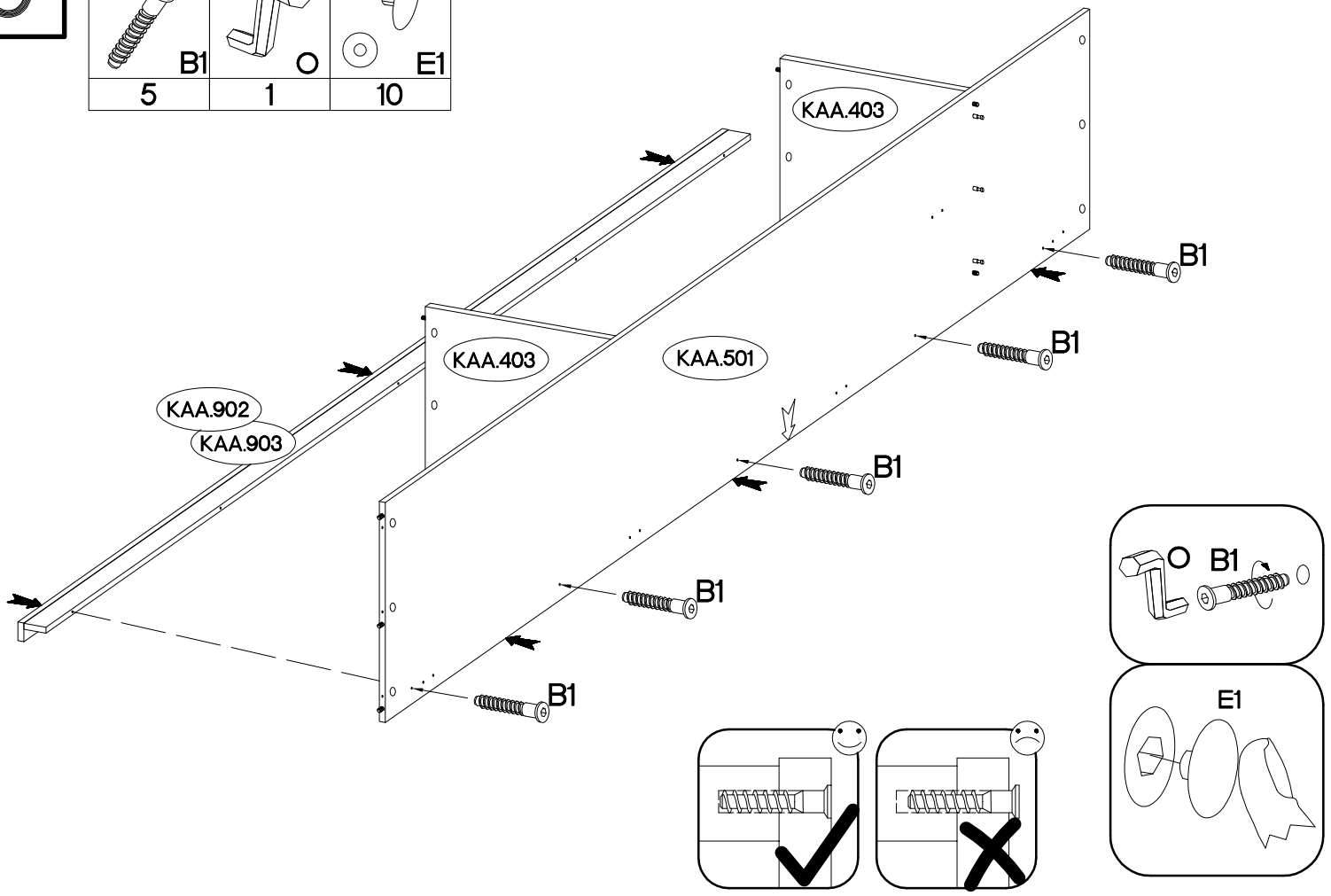
6,4 x 35mm		
		
B1	O	E1
5	1	10

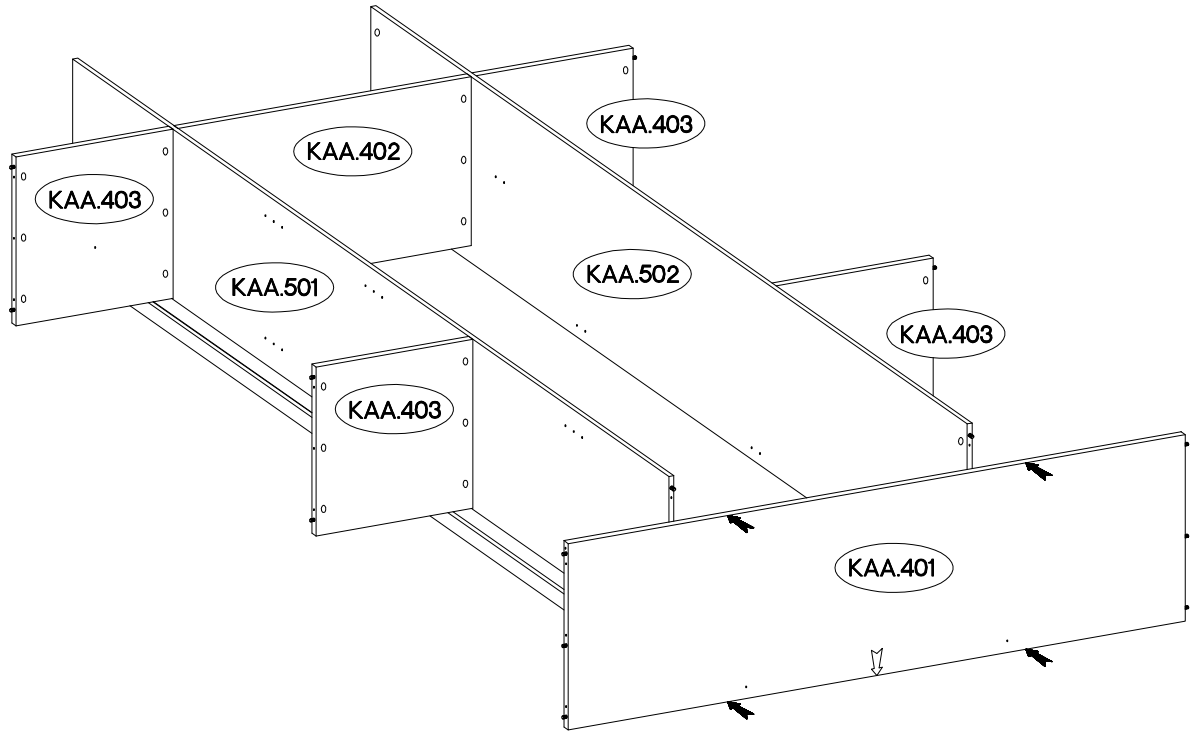
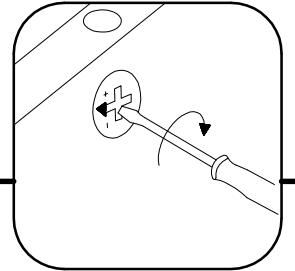
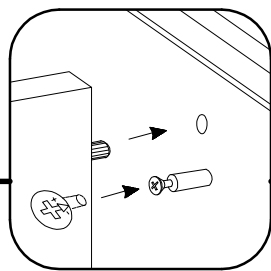
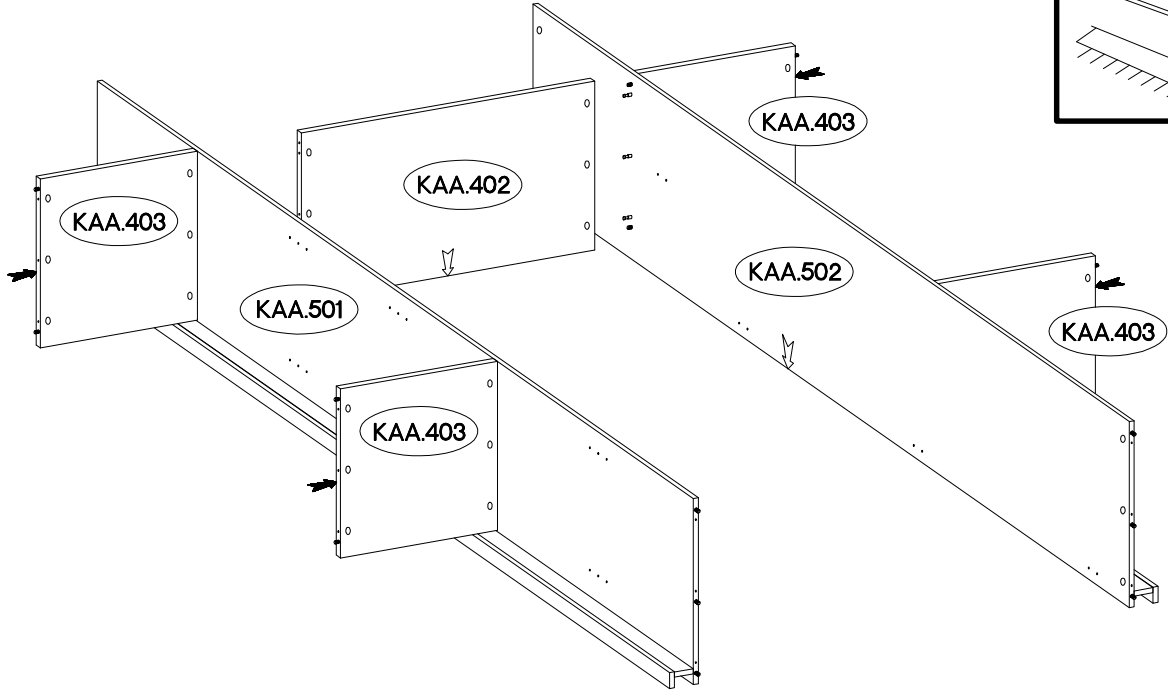
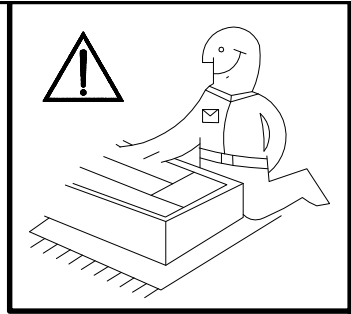



12

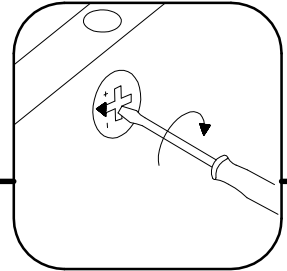
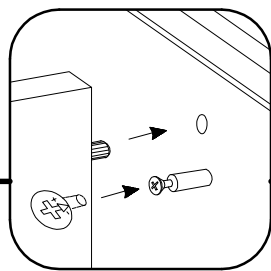
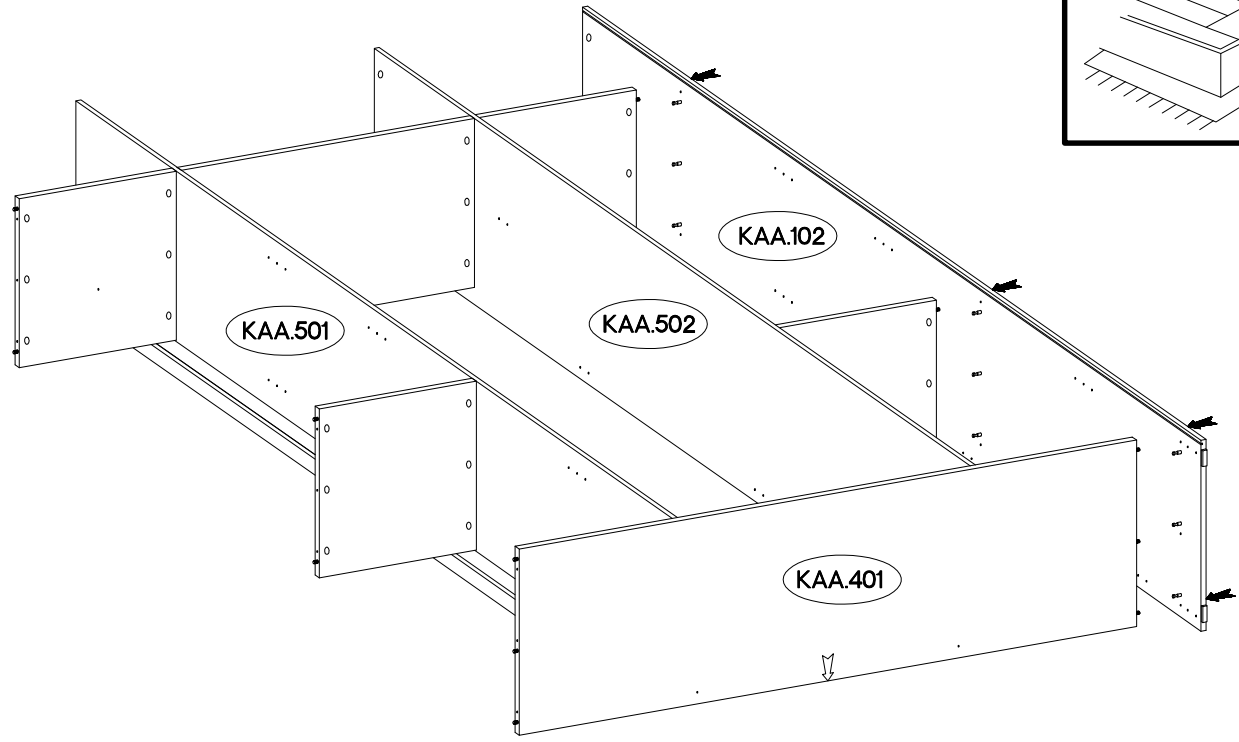
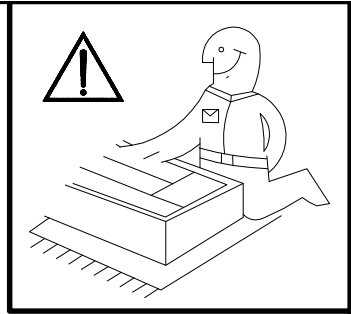

13

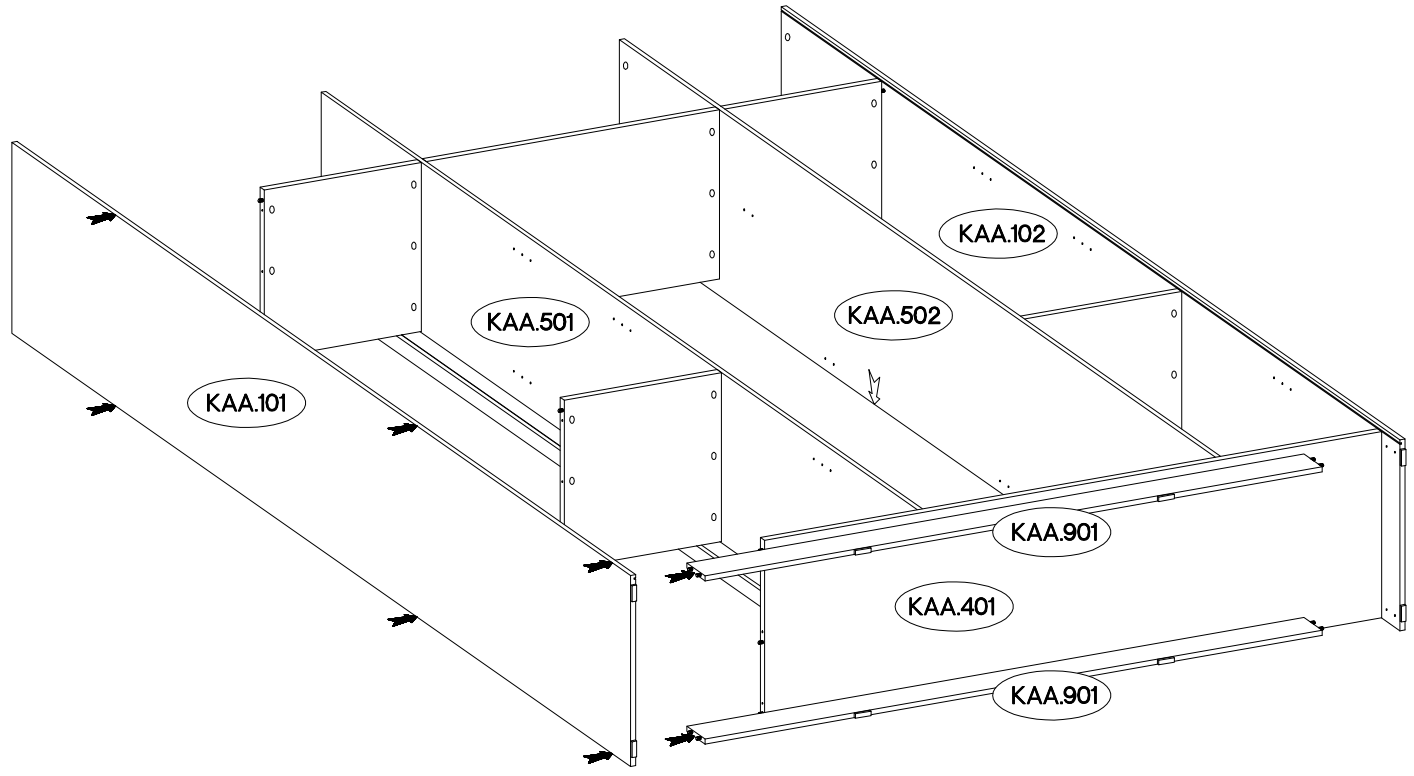

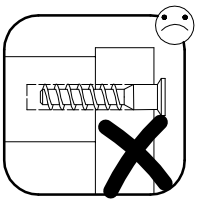
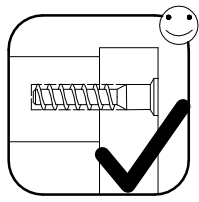
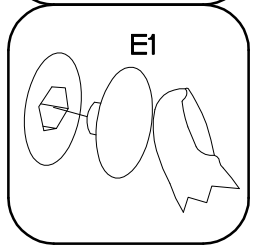
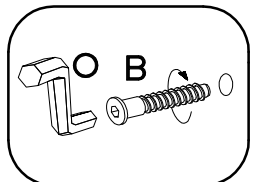
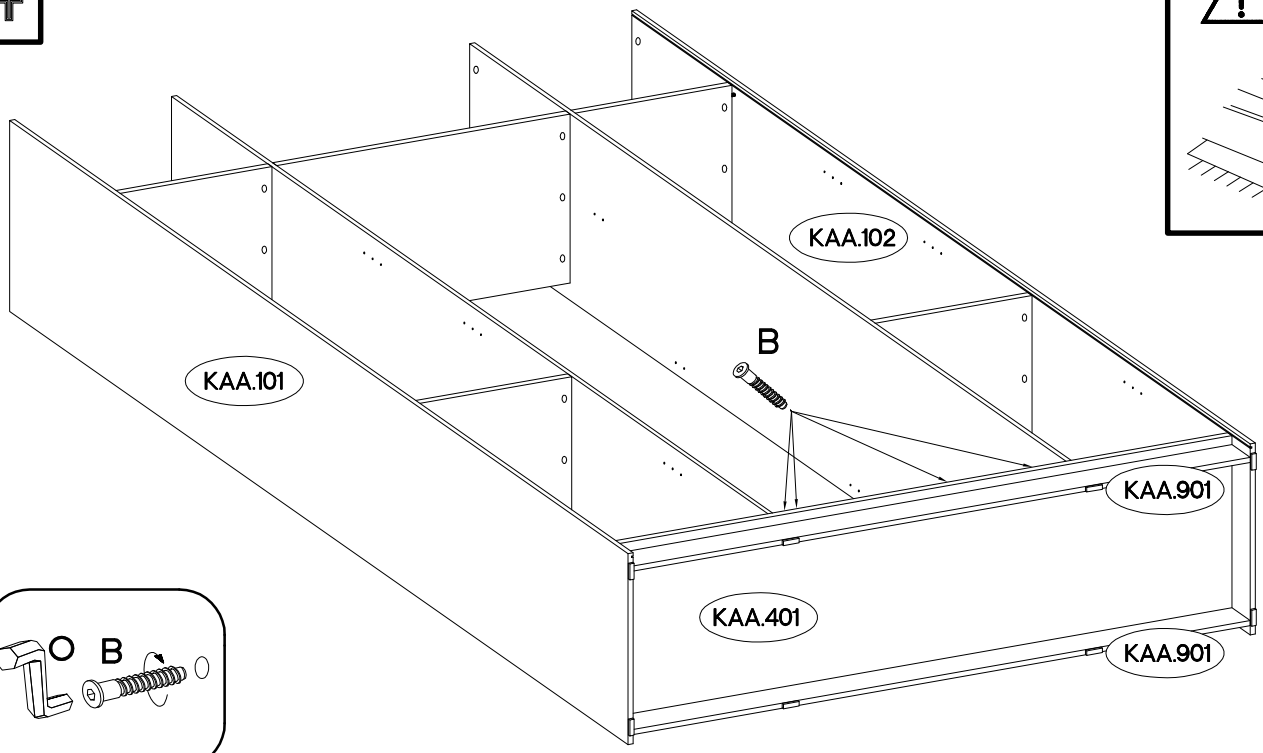
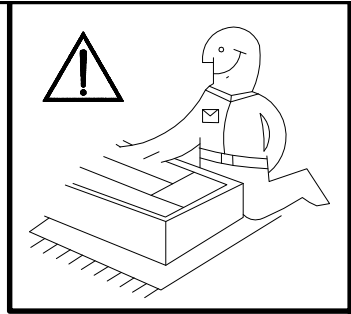

14





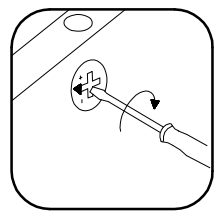
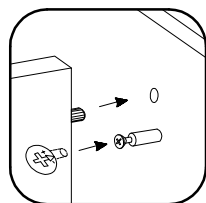
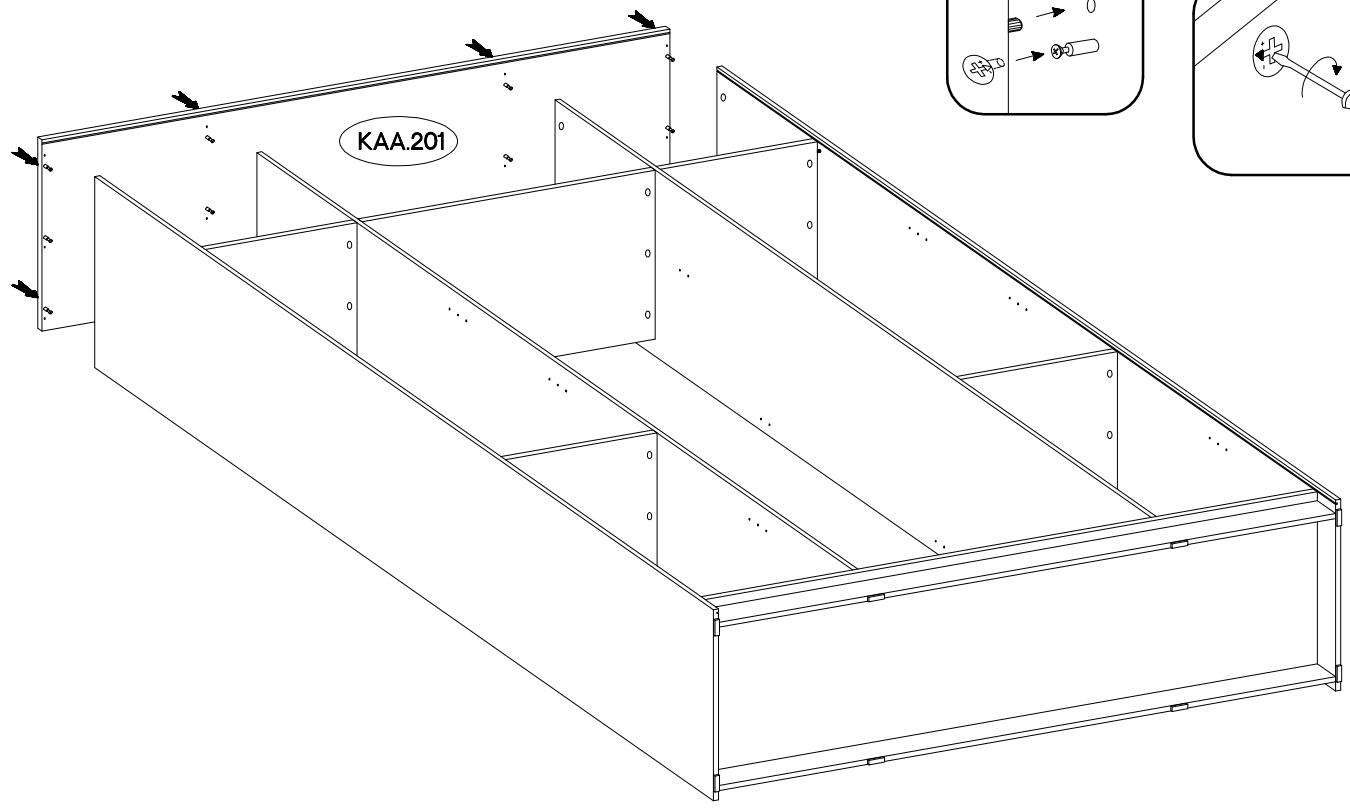

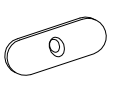
6,4 x 50mm			
	<b>B</b>	<b>O</b>	<b>E1</b>
	4	1	4

15

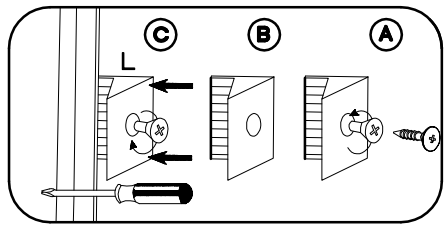
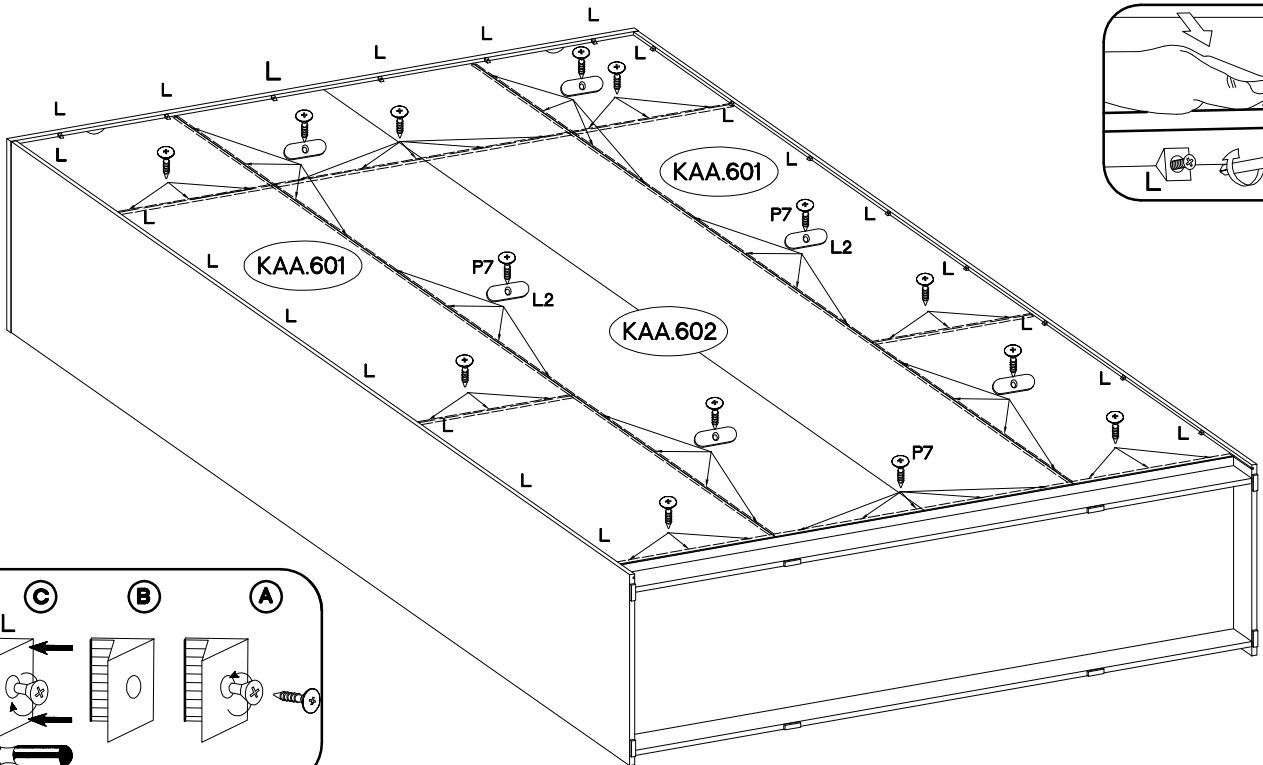
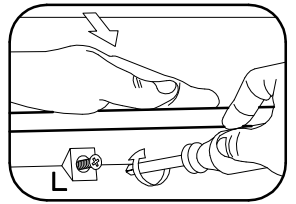
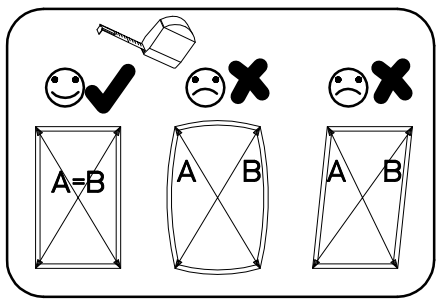
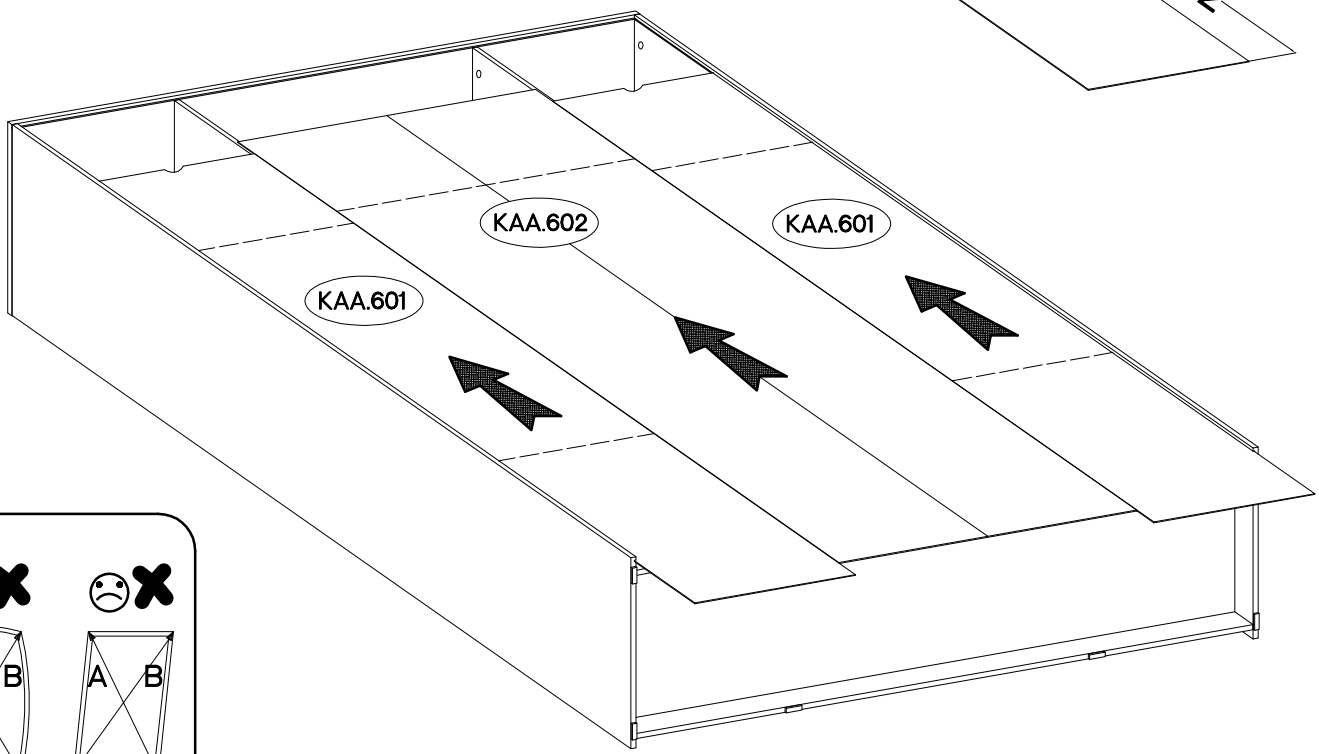
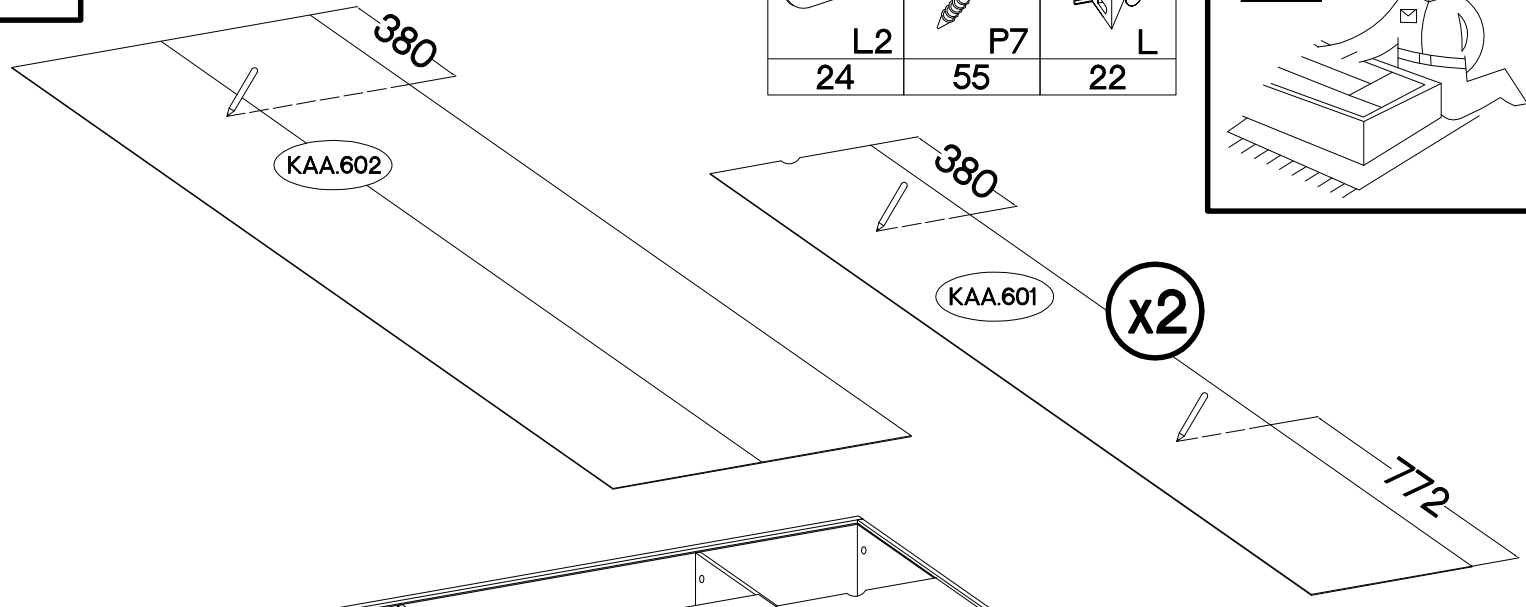
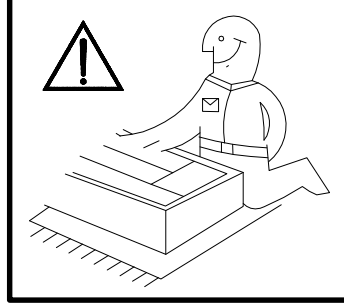

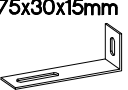



	↑3.0x20mm	
L2		P7
24		55
		L

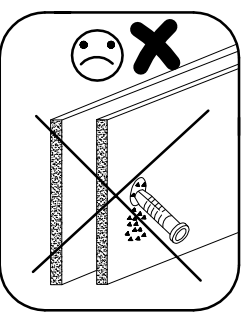
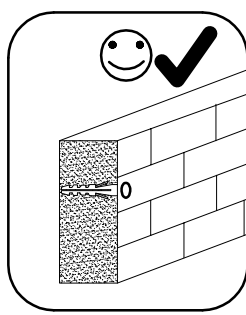
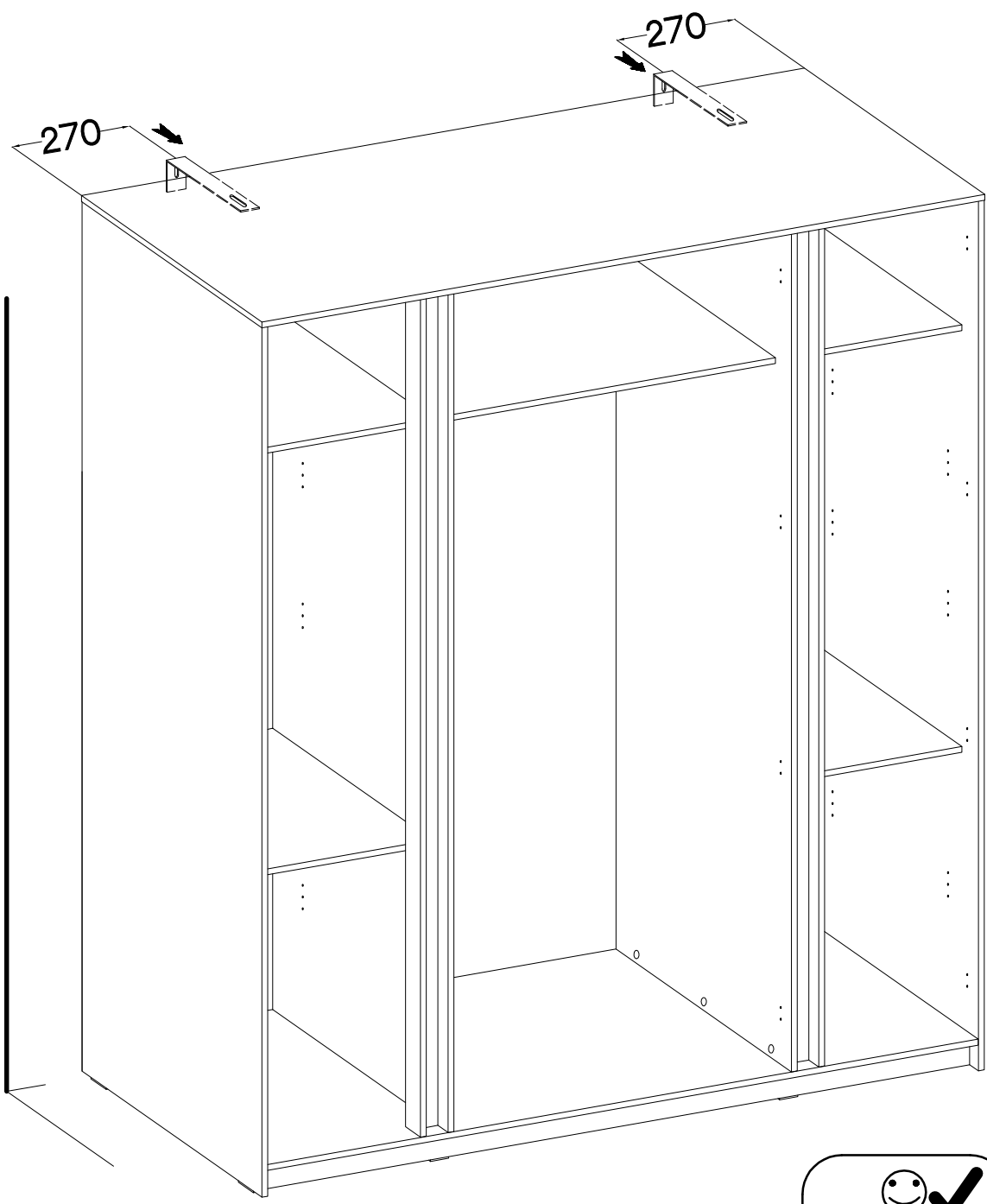
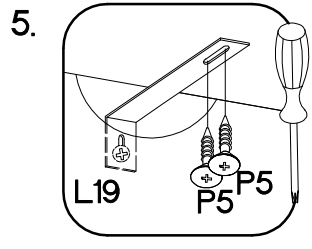
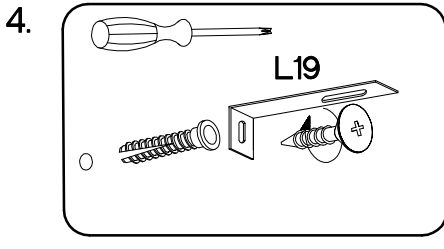
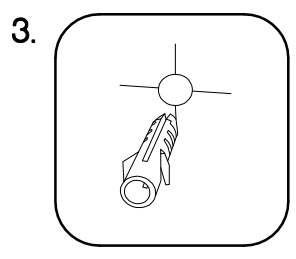
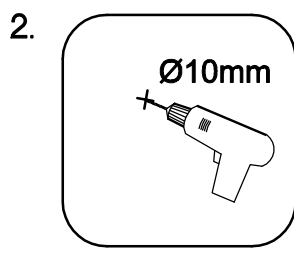
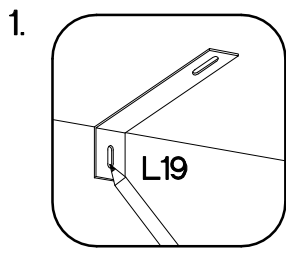

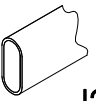
75x30x15mm	±3.5x13mm	±5.0x60mm	±10x50mm
			
L19	P5	P12	O7
2	4	2	2



L=926mm  J2	 J17	±3.5x13mm  P5	±5/16mm  J3	 E
1	2	2	24	48

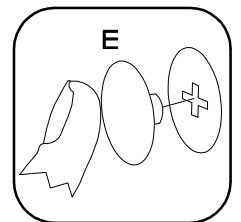
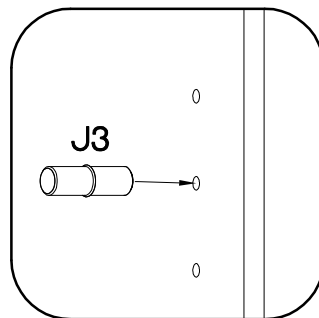
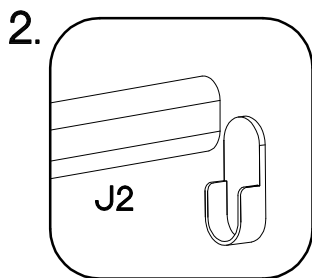
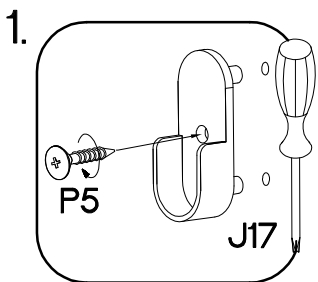
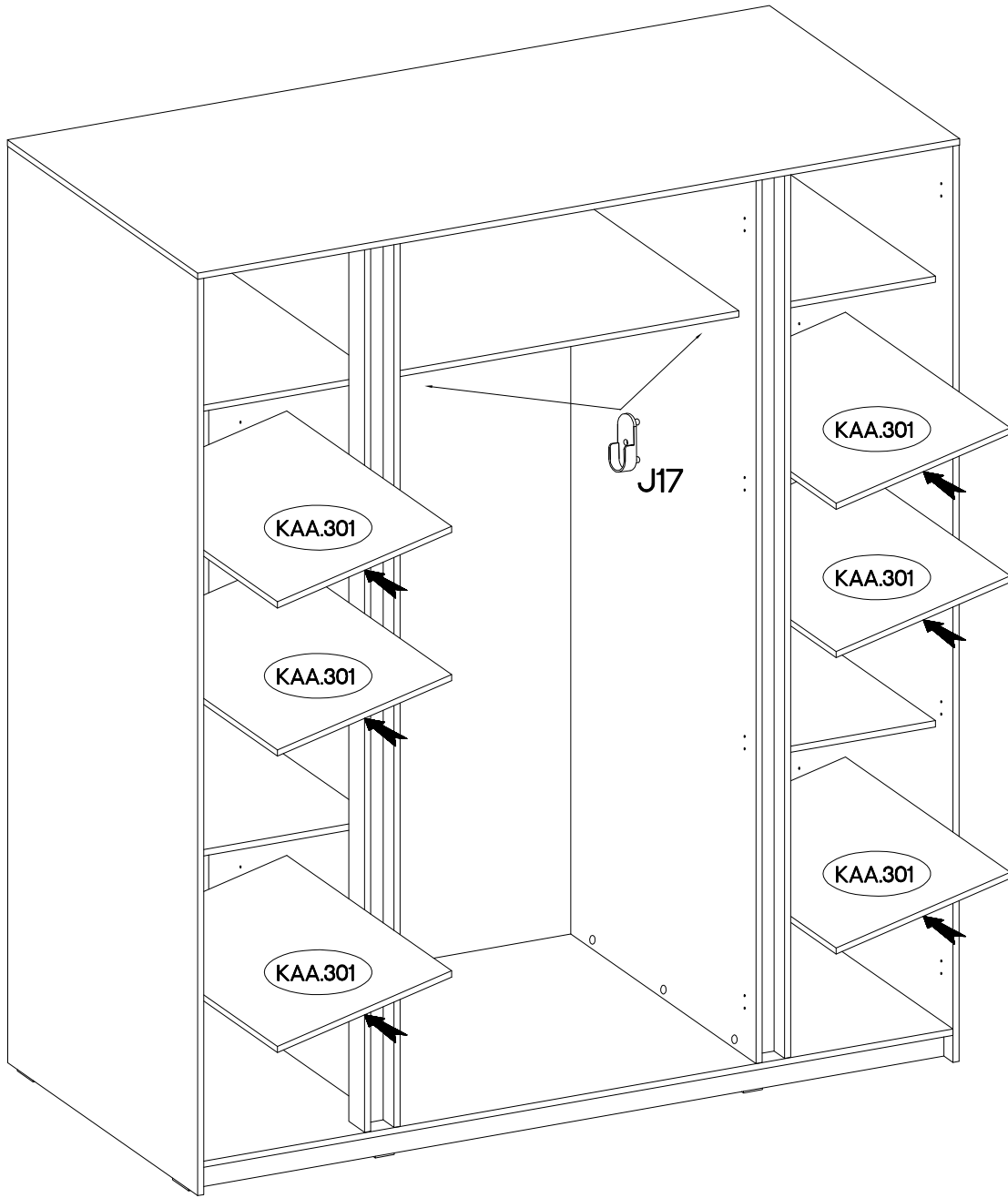



VARIANT - LED

15x15-L=2275mm  
J58  
1

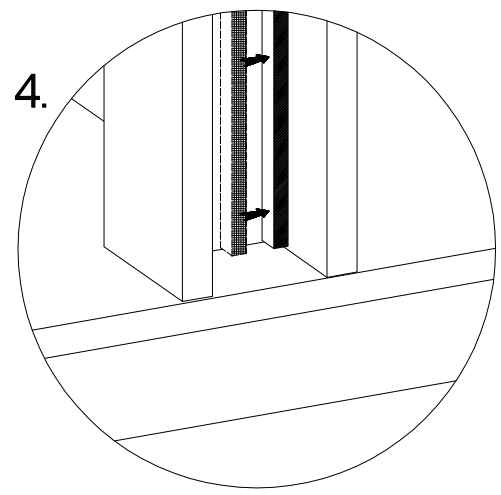
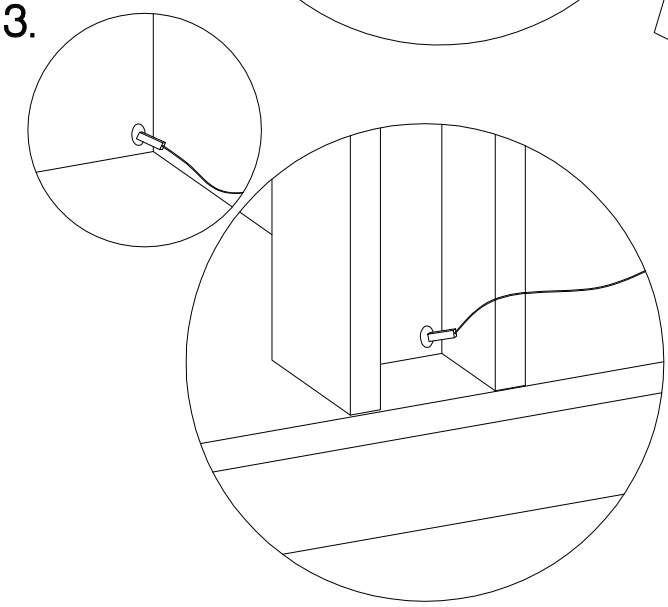
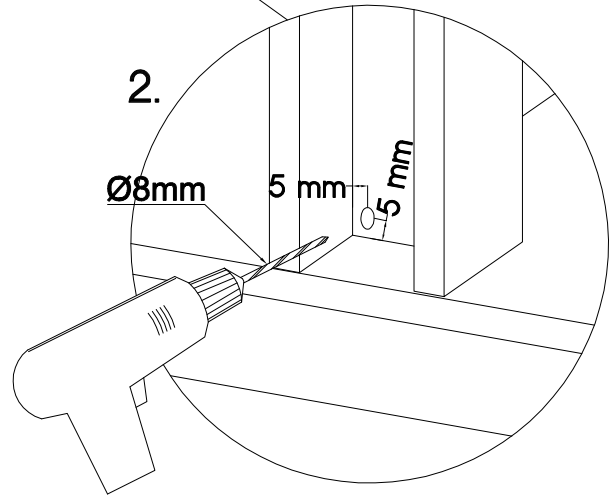
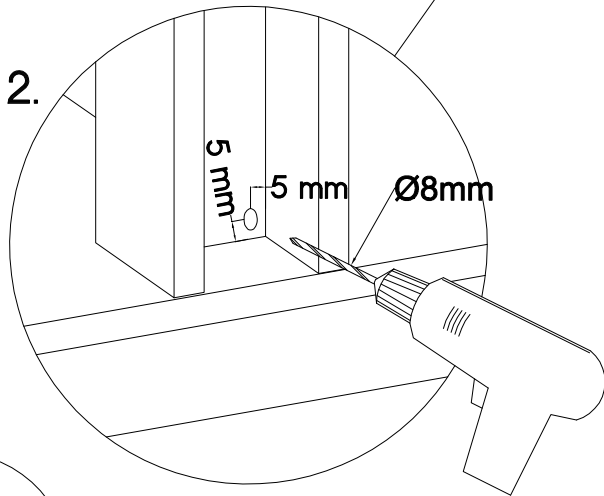
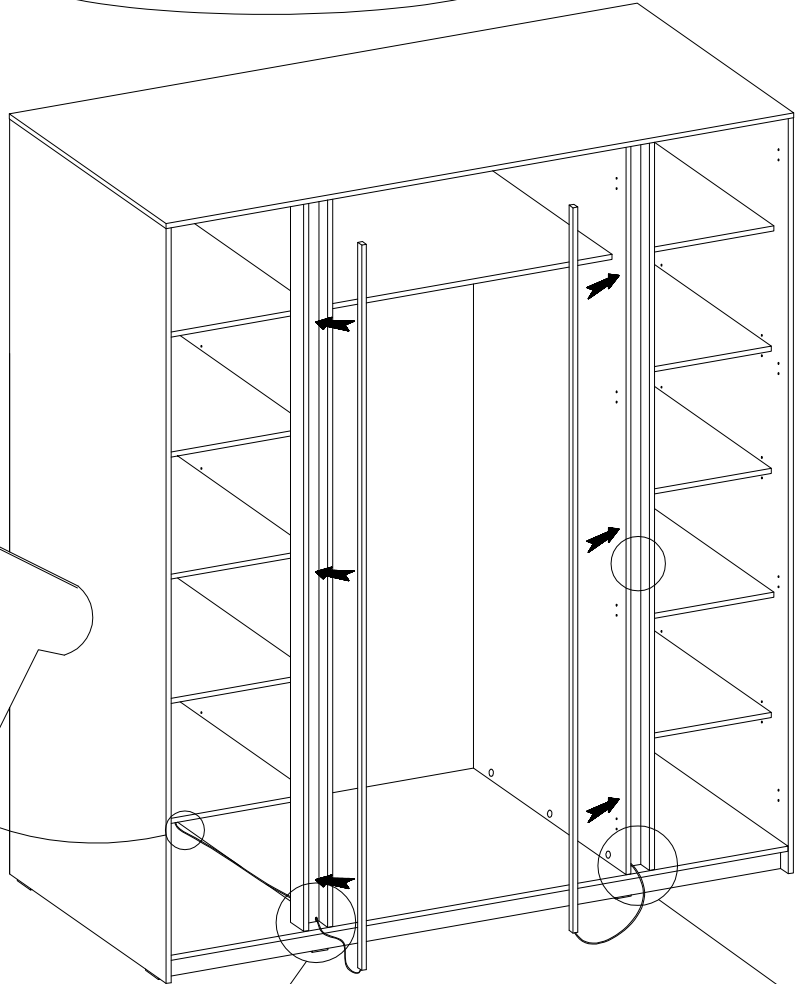
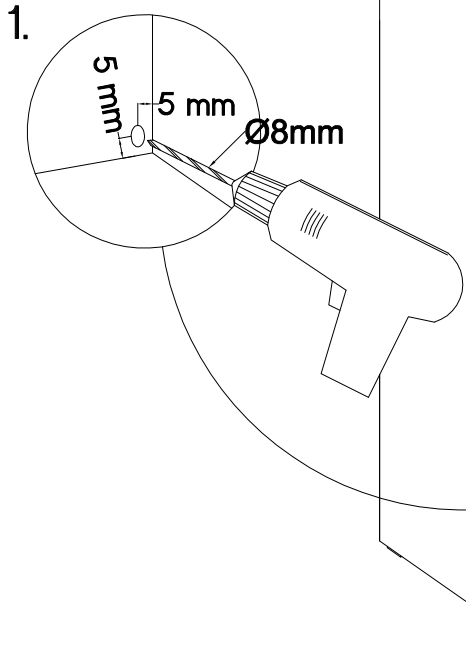
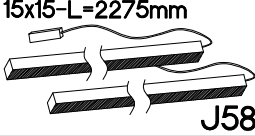



KA.A.701

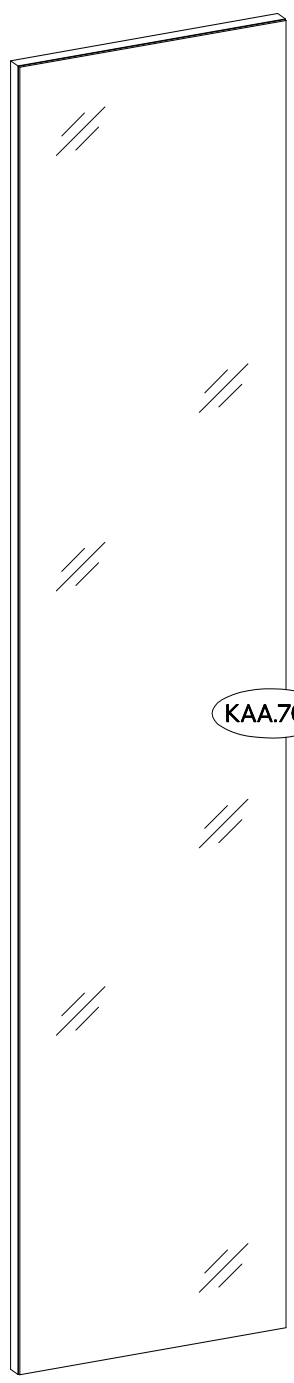

KA.A.702





KA.A.706  
KA.A.904

# 21

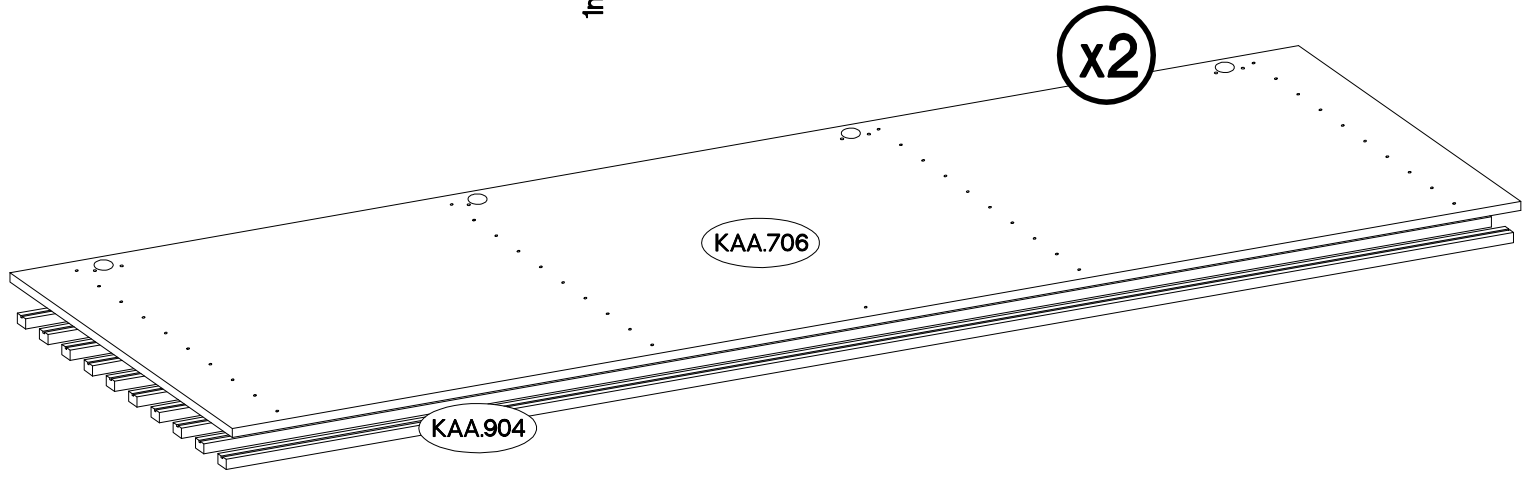
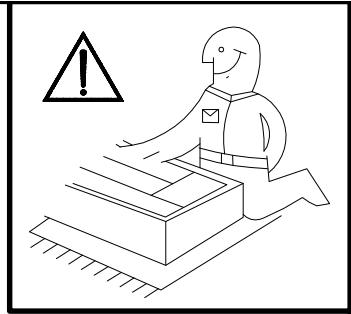
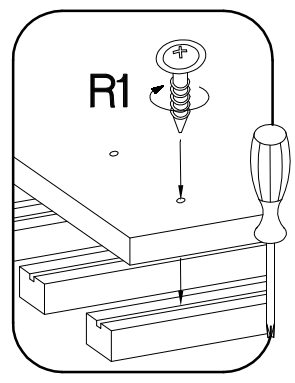
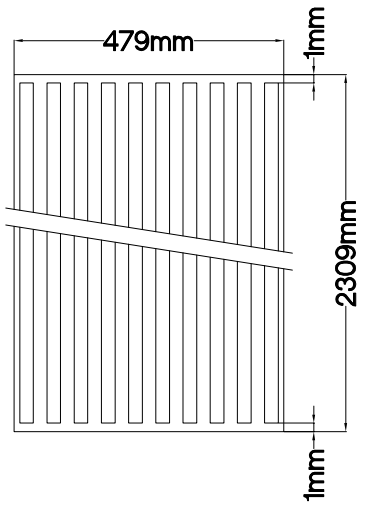
+4.0x27mm

R1
82

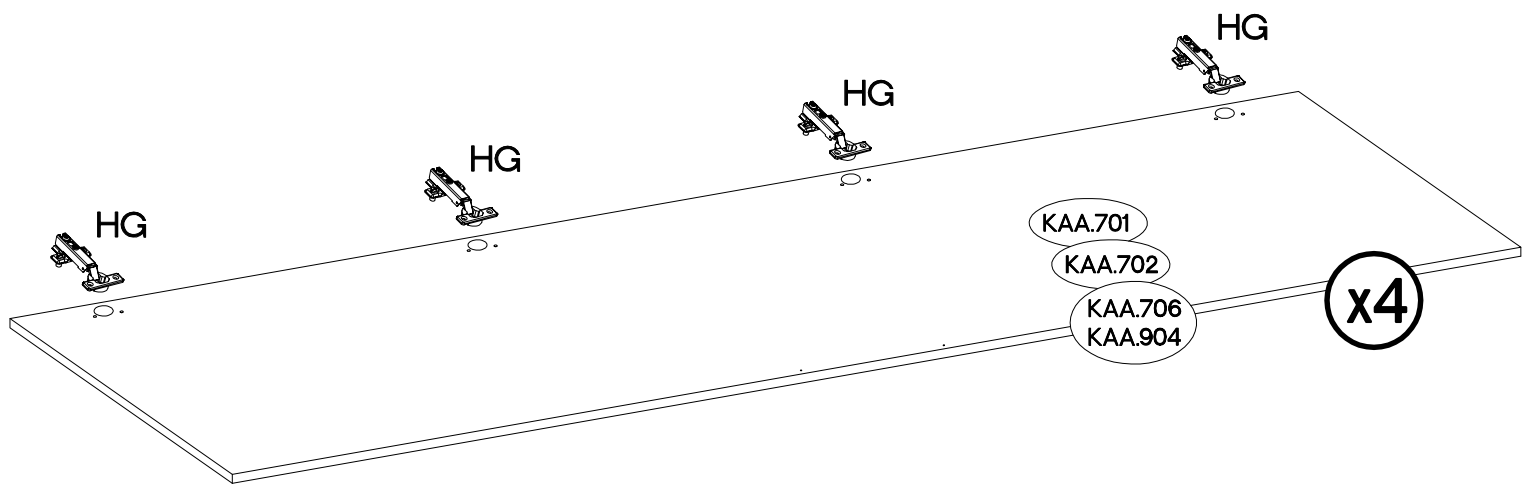
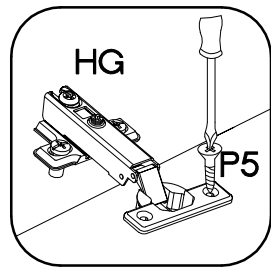

# 22

+35/0mm	+3.5x13mm
	
HG	P5
16	32

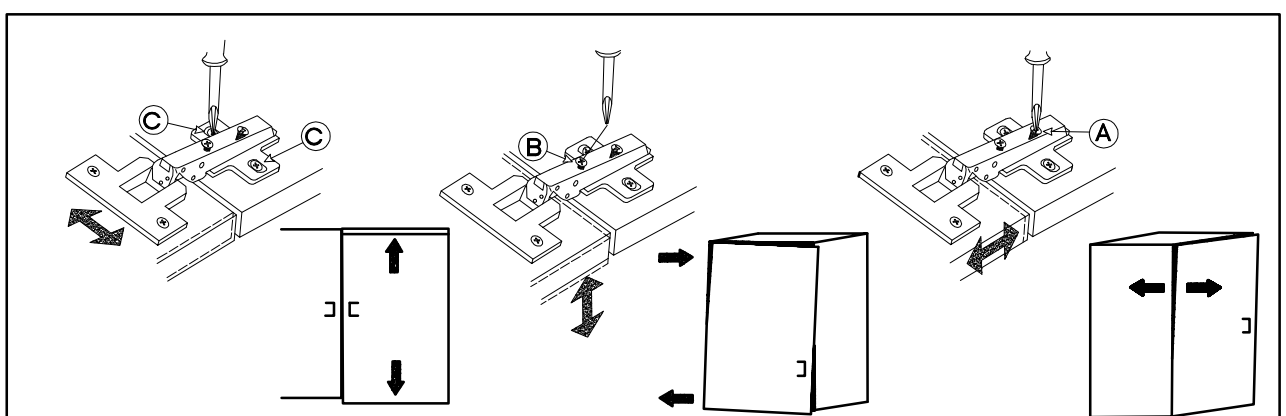
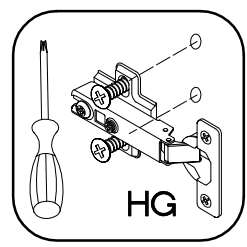
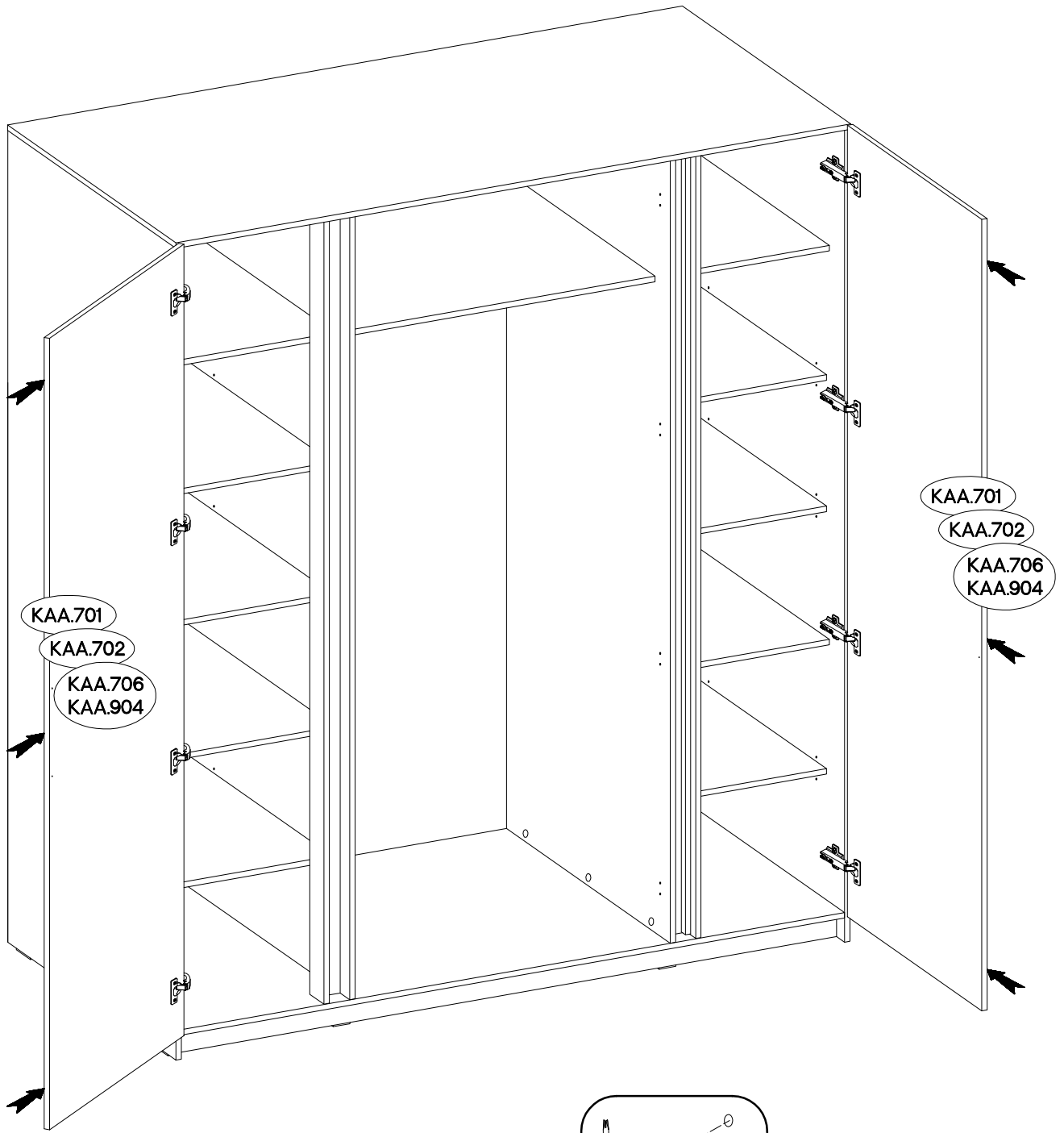



L=256mm

S

1

