

120 min

ELENA 2D 3S

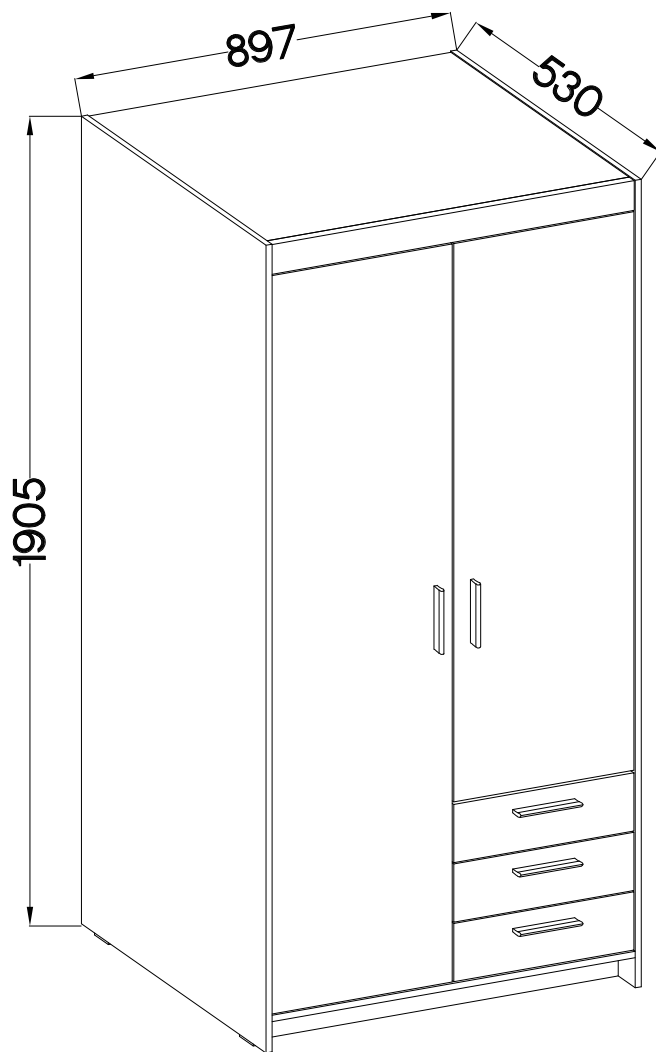
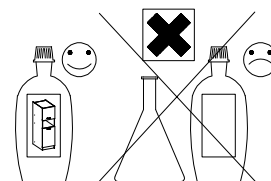

 A 54	 B2 6	 C 20	 C5 6	 D2 26	 E 20	 F2 4	 F4 2
 HG2 6	 I15 3	 J2 1	 J3 12	 J17 2	 L2 12	 L19 1	 M2 18
 M4 18	 O7 1	 P5 25	 P7 45-50	 P12 1	 R2 10	 S 5	

P-ISM-ELA-13

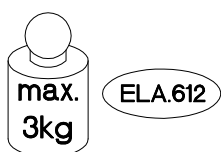
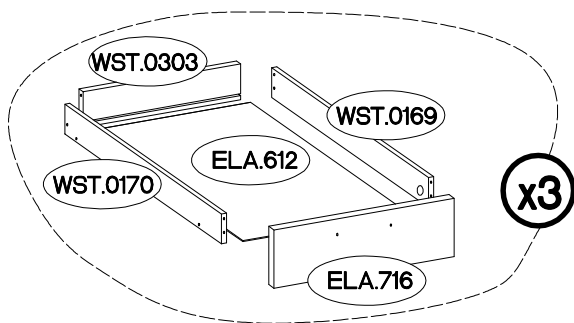
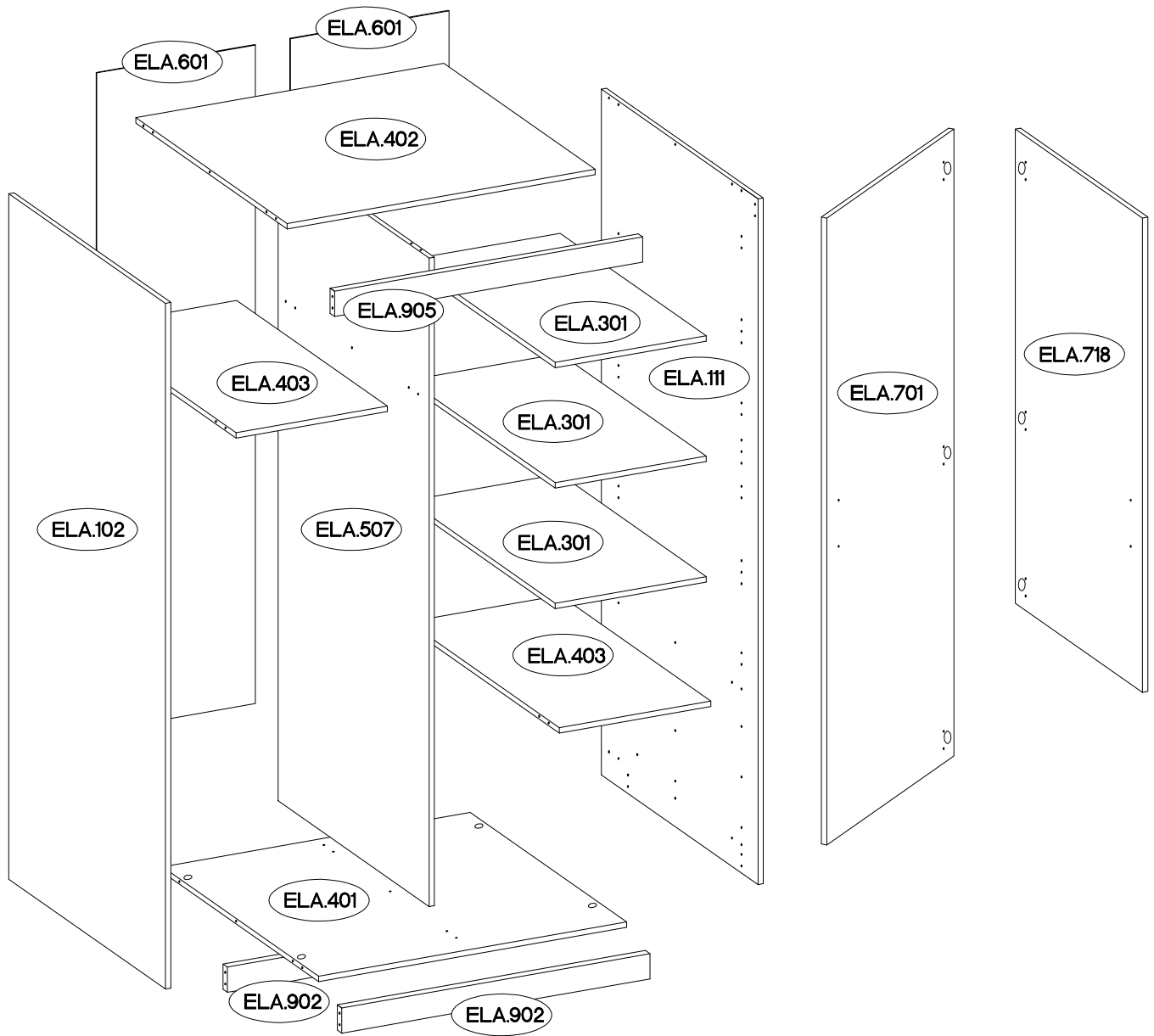



Colli	Ersatzteil Nummer	Dimension
Colli 1/2	ELA.102	1900x530x15
	ELA.301 x3	425x495x15
	ELA.401	867x529x15
	ELA.402	867x512x15
	ELA.403 x2	426x510x15
	ELA.901	867x70x15
	ELA.902 x2	867x70x15

Colli	Ersatzteil Nummer	Dimension
Colli 2/2	ELA.111	1900x530x15
	ELA.507	1797x511x15
	ELA.601 x2	1825x446x2,5
	ELA.612 x3	399x448x2,5
	ELA.701	1737x430x15
	ELA.716 x3	430x137x15
	ELA.718	1314x430x15
	WST.0169 x3	450x70x12
	WST.0170 x3	450x70x12
WST.0303 x3	376x84x12	

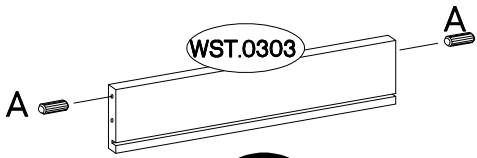
1



$\varnothing 12/10\text{mm}$  C5 6	$\varnothing 8 \times 30\text{mm}$  A 12
---	--

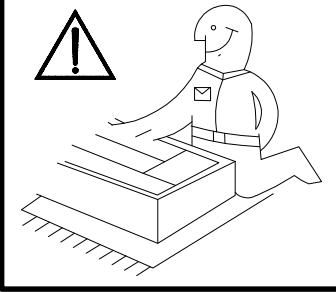

x3

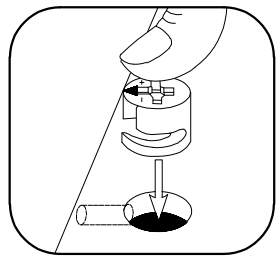
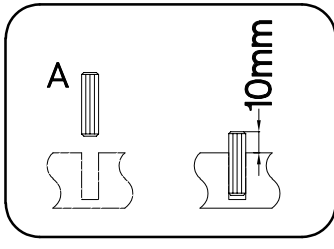
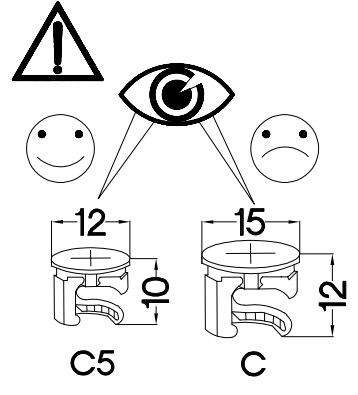
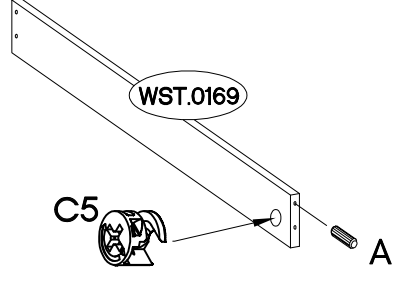
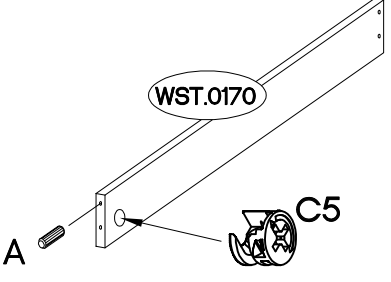

2

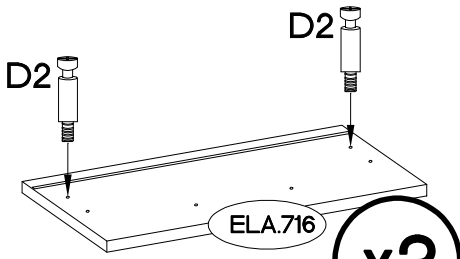
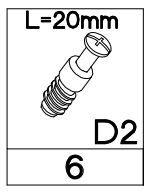

x3

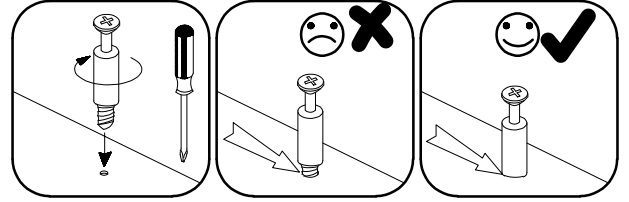

3

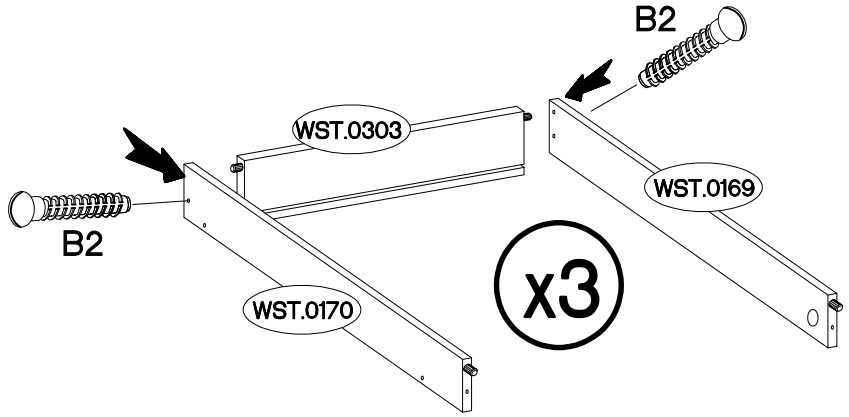
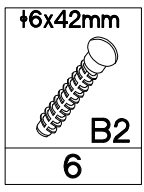

x3

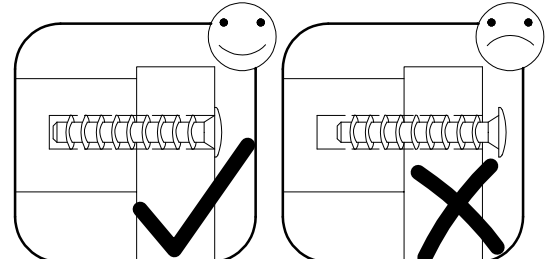
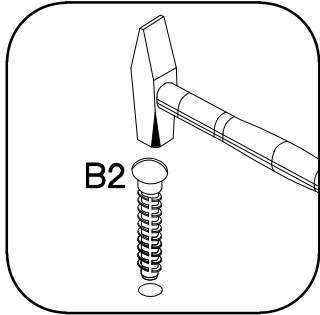

4

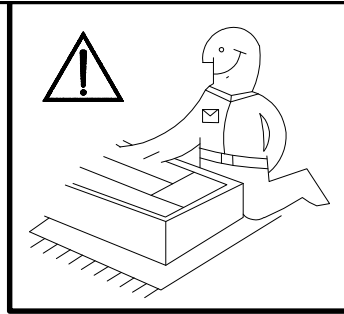
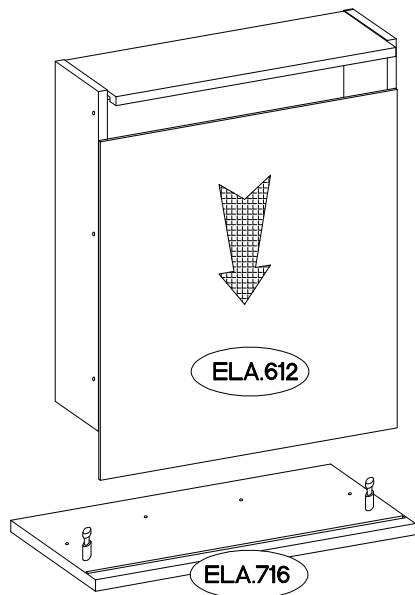

x3

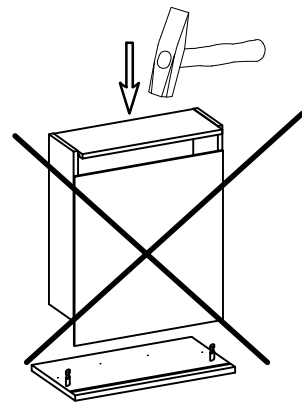
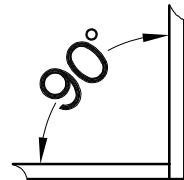
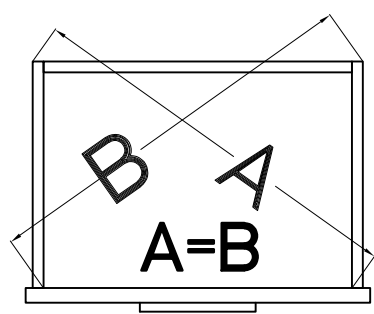
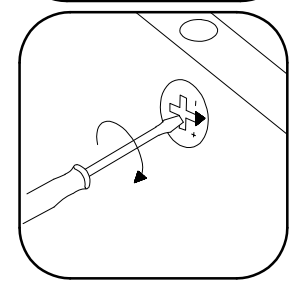
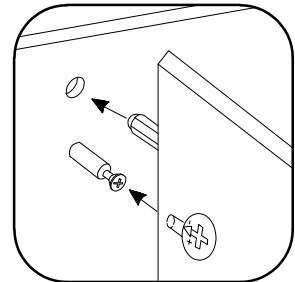





5

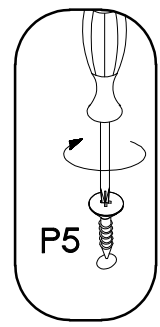
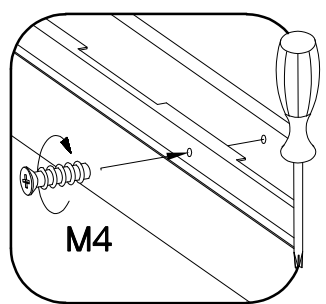
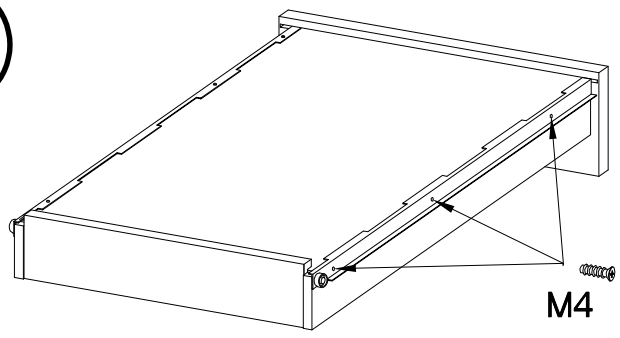
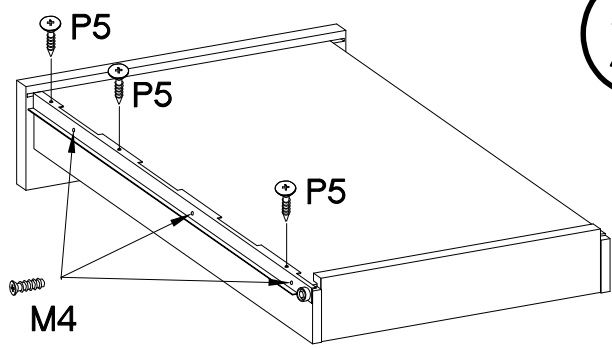

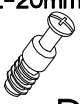

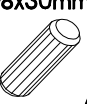

L=450mm	+6,3x9,5mm	+3.5x13mm
115	M4	P5
3	18	9

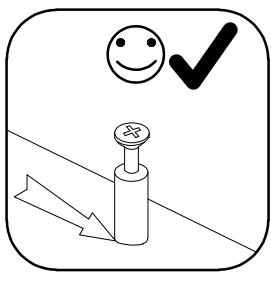
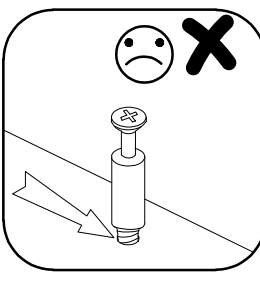
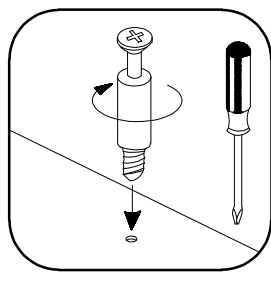
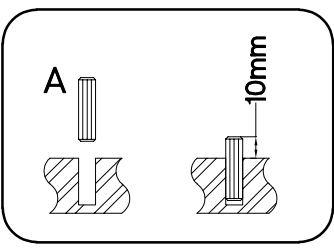
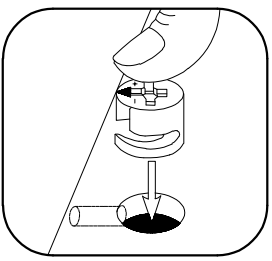
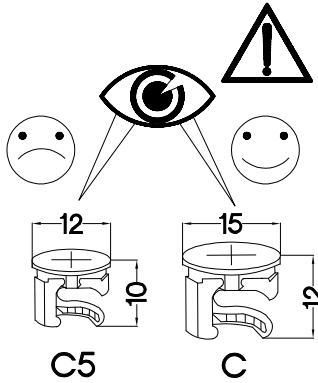
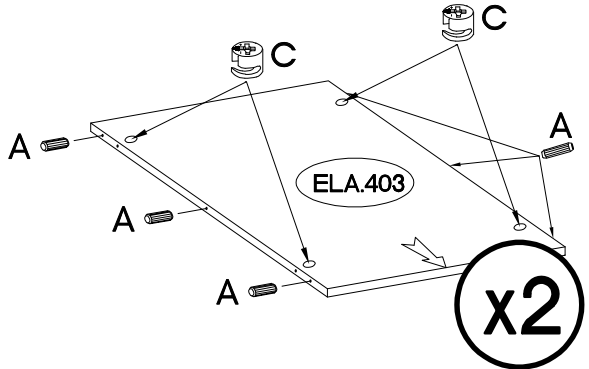
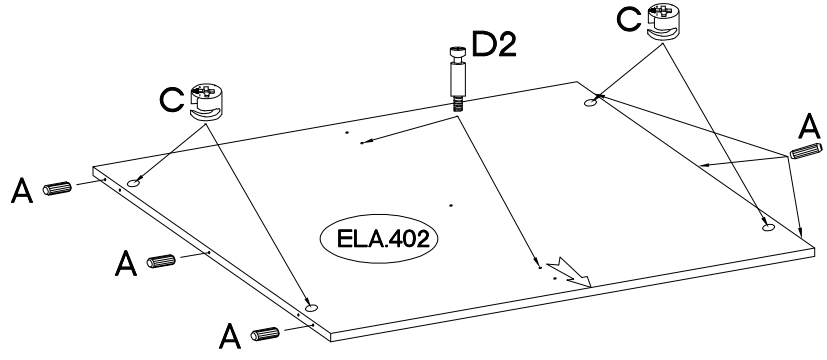
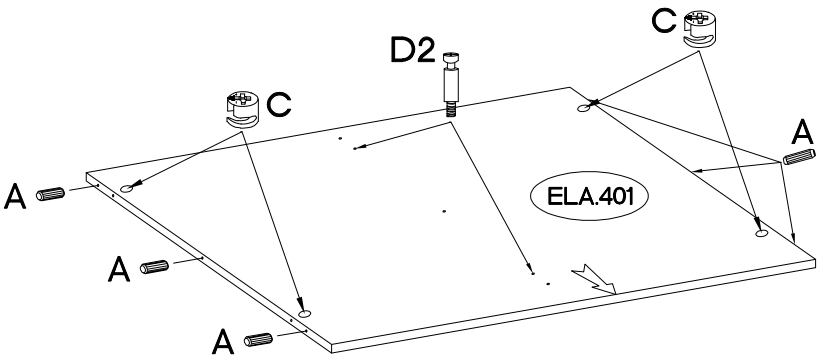
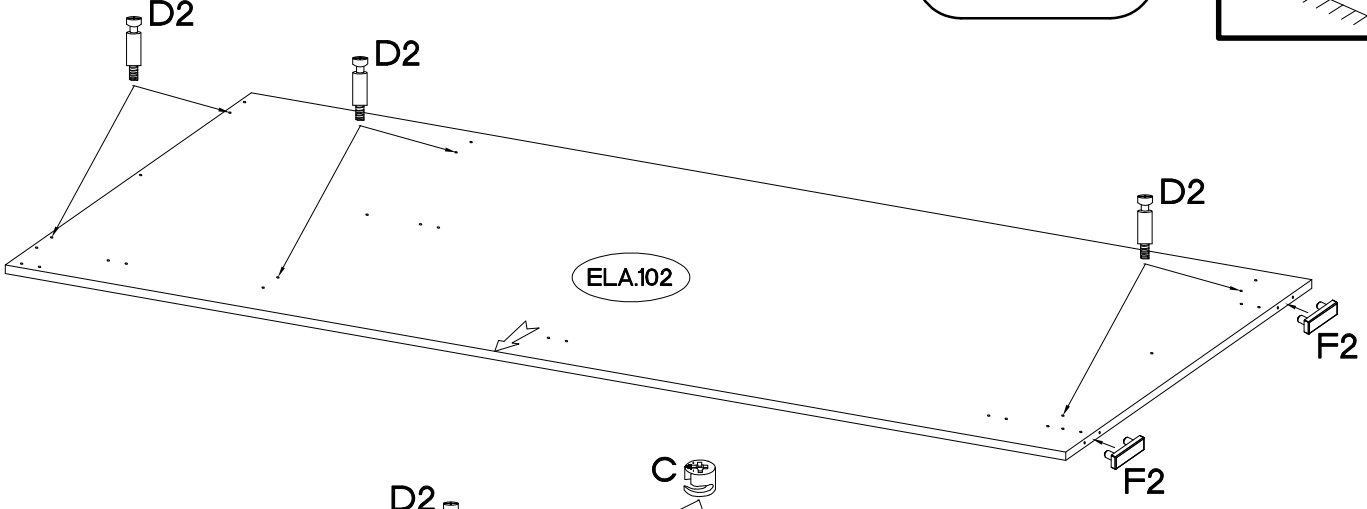
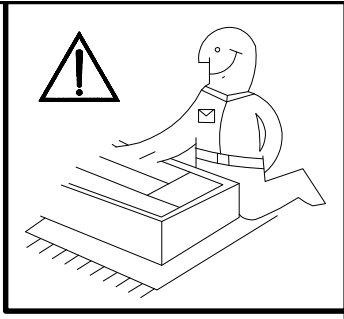
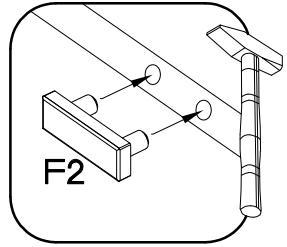
x3

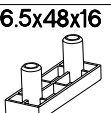

L=20mm	6.5x48x16	∅8x30mm	∅15/12mm
			
D2	F2	A	C
10	2	24	16



L=20mm  D2 10	6.5x48x16  F2 2	†8x30mm  A 18	†15/12mm  C 4	L=450mm  I15 3	†6,3x13mm  M2 18	†15x5mm  F4 2
--	--	--	--	---	---	---

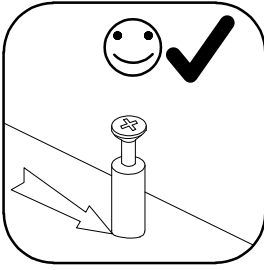
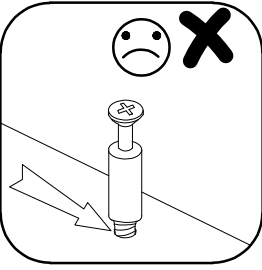
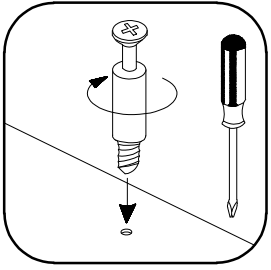
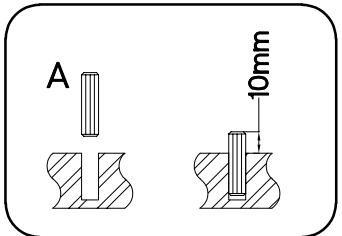
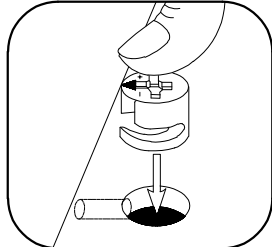
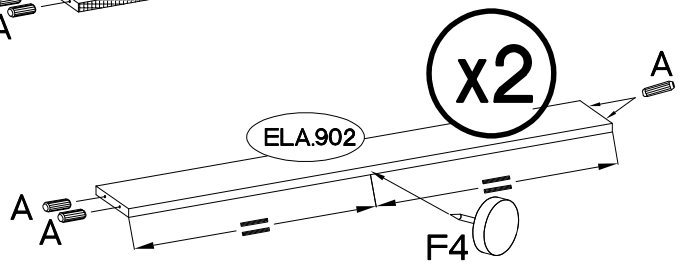
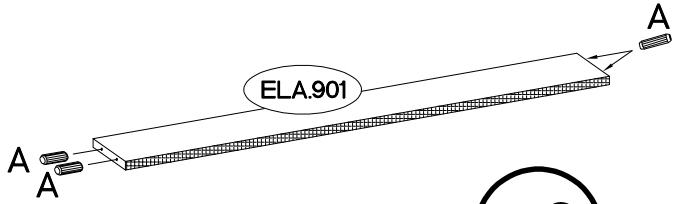
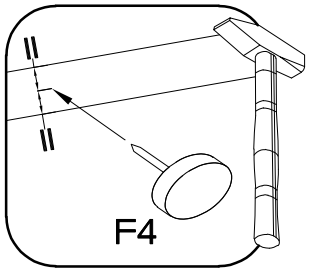
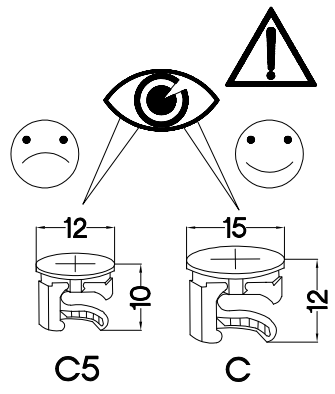
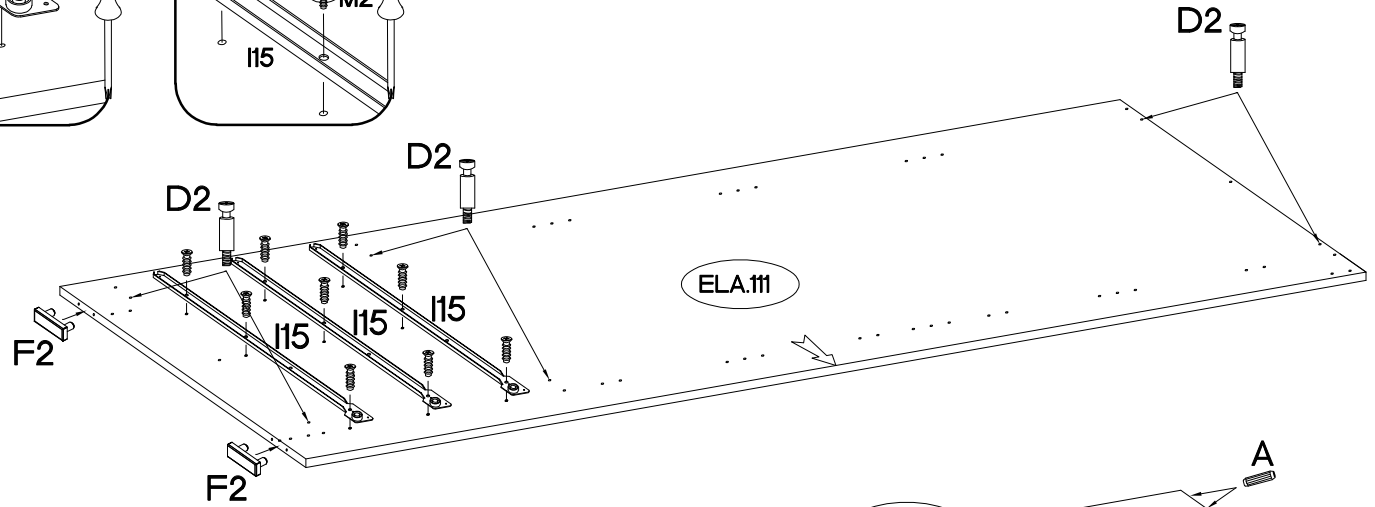
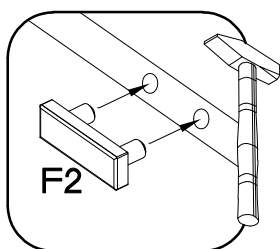
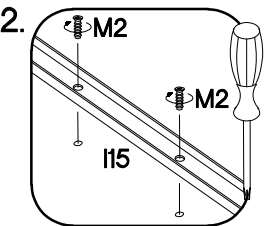
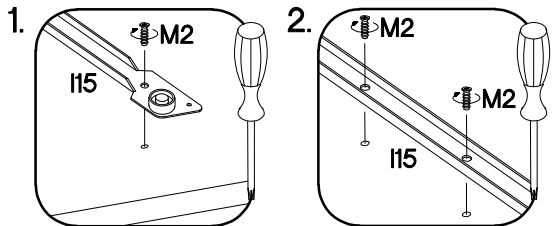
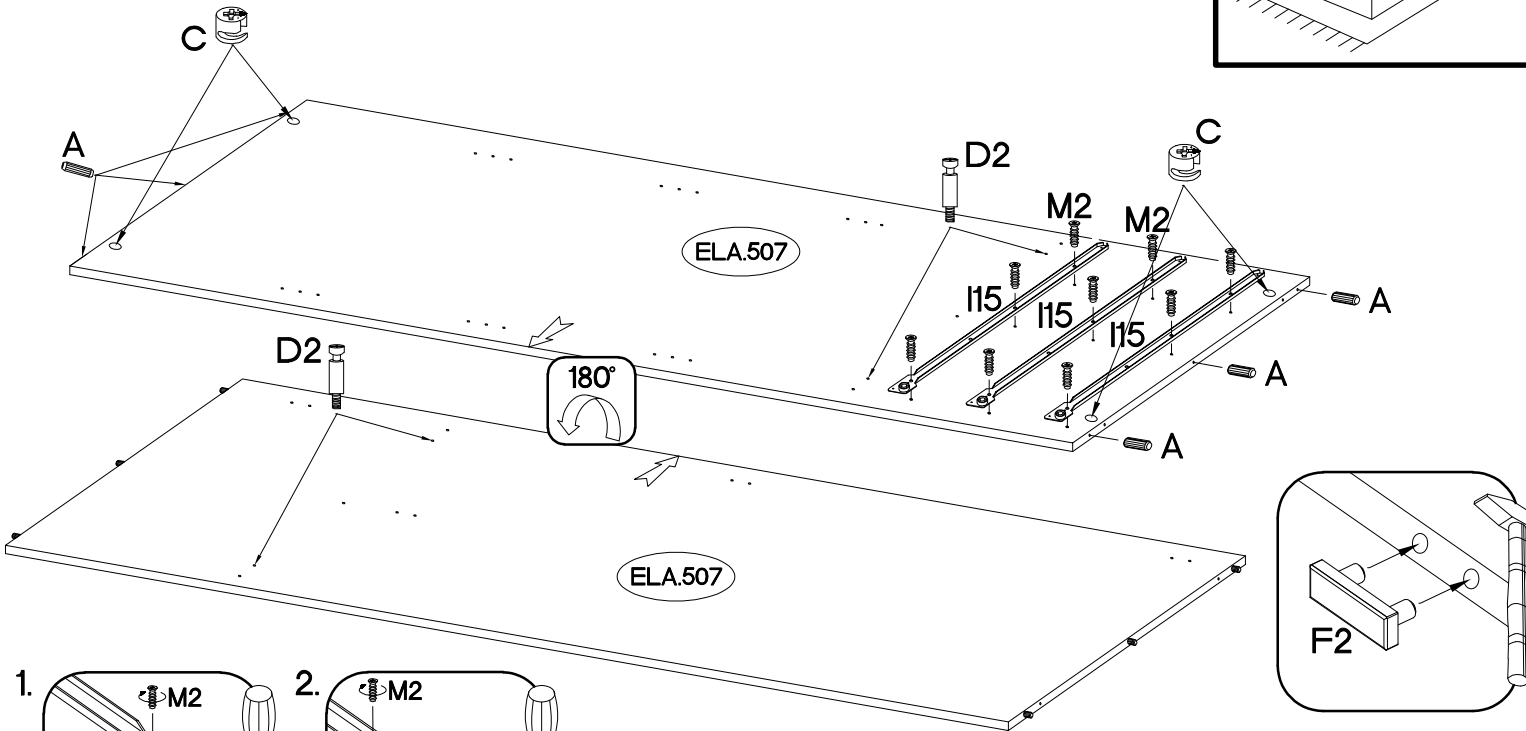
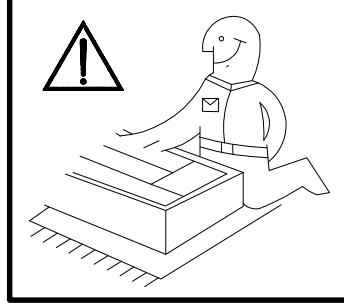

8

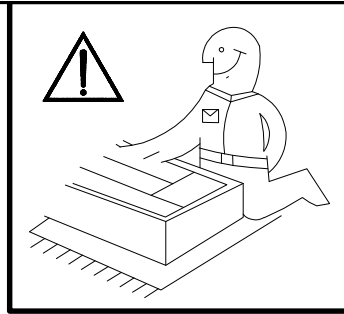
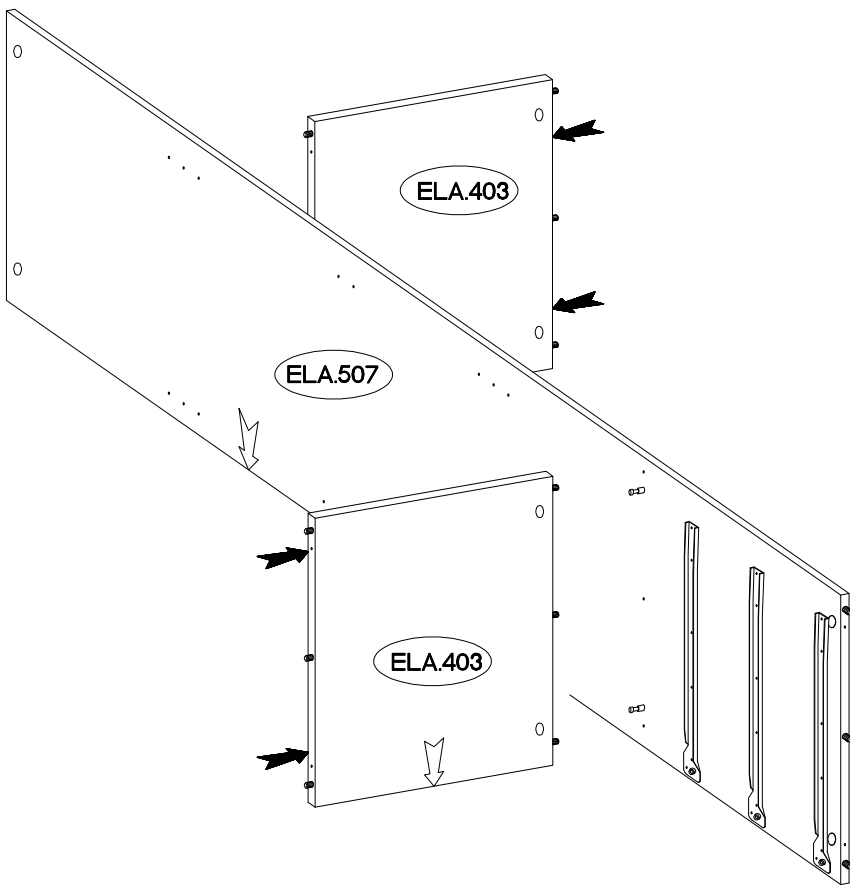

9

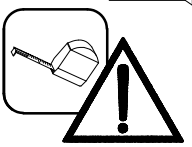
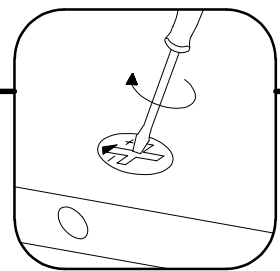
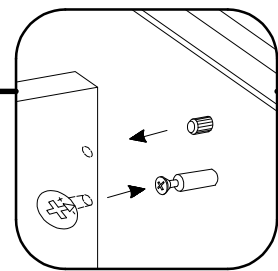
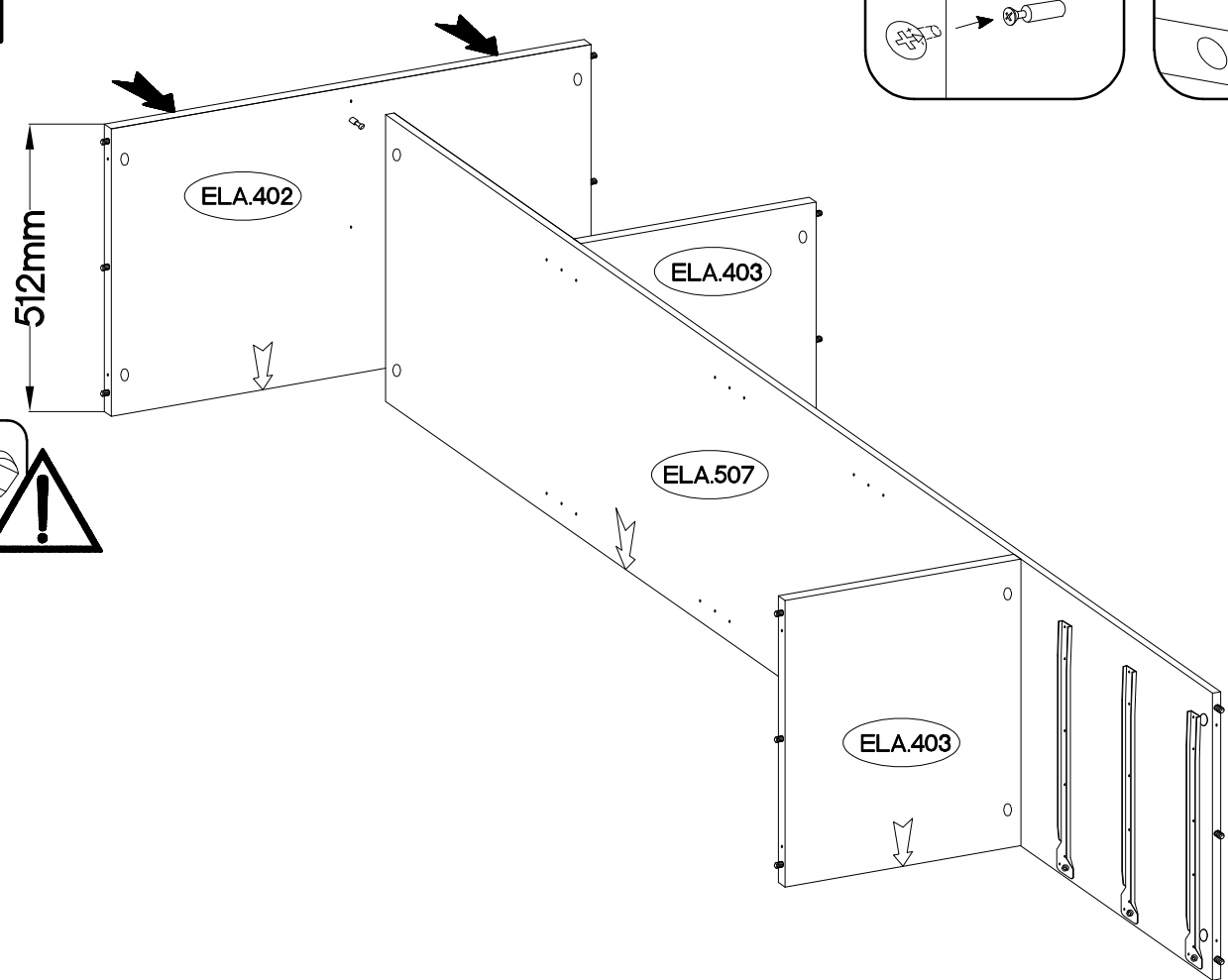

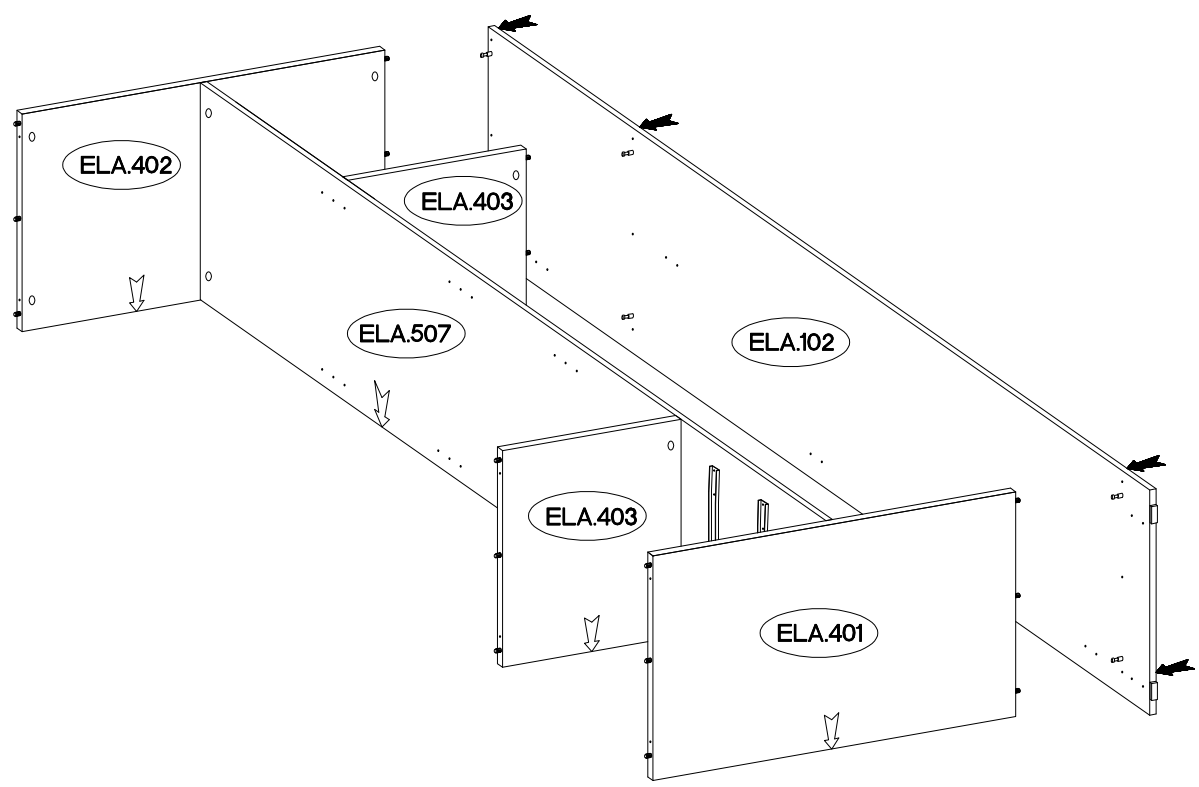
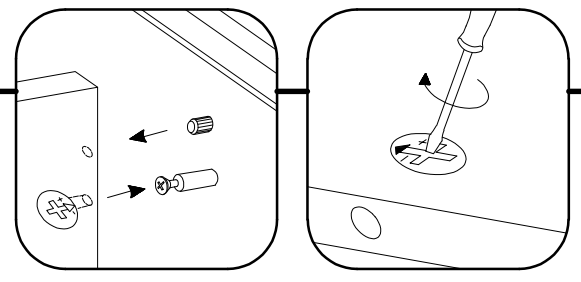
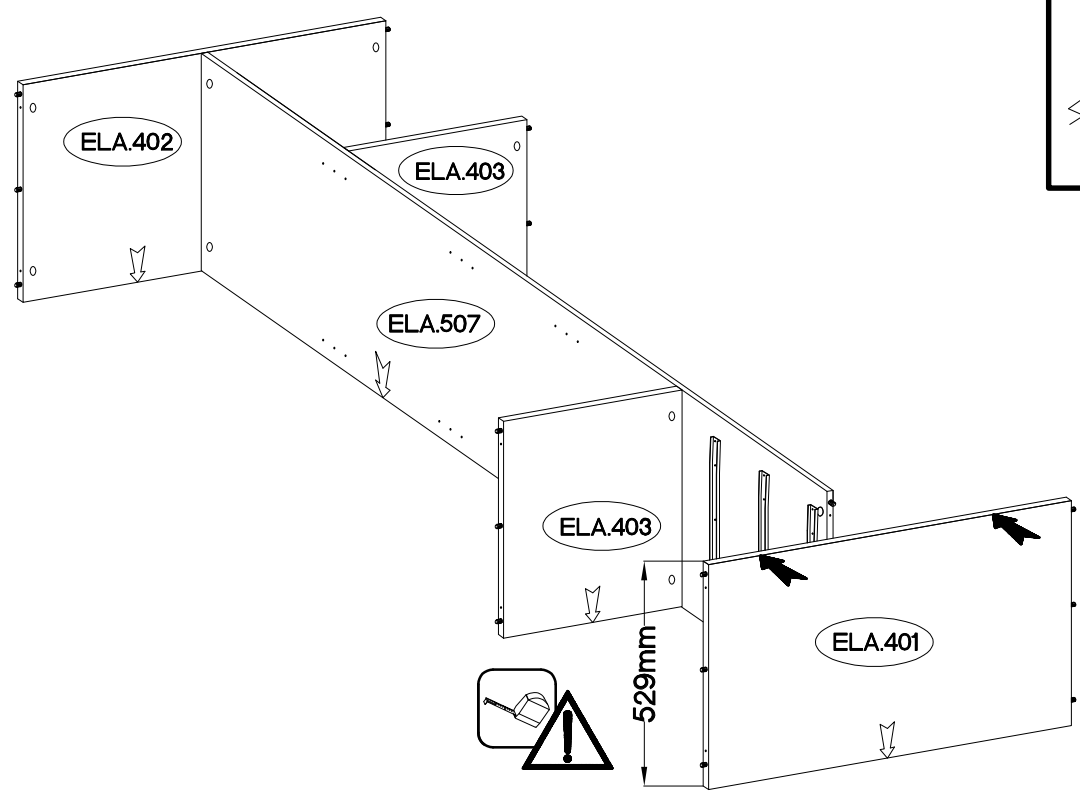
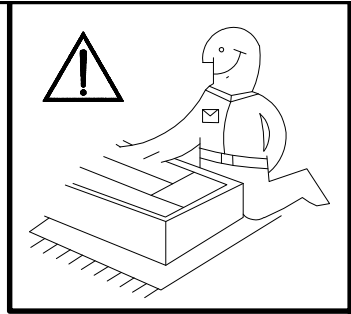

12

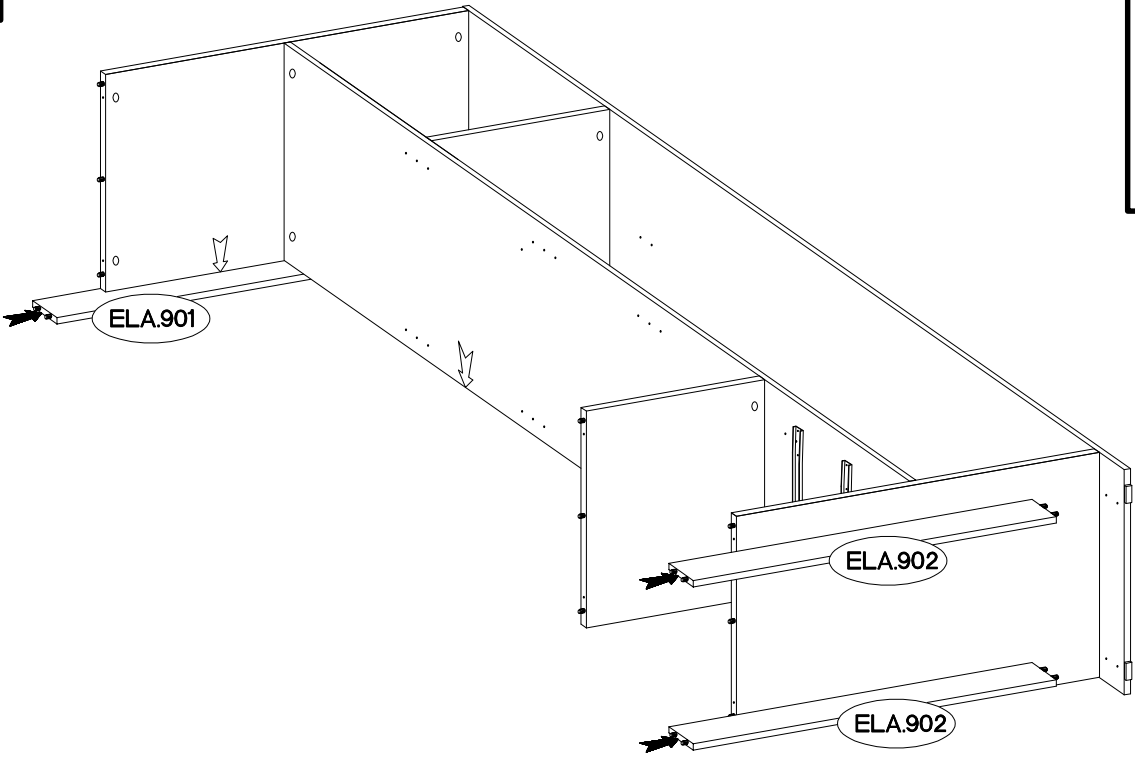
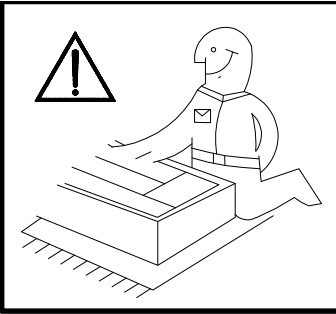

13

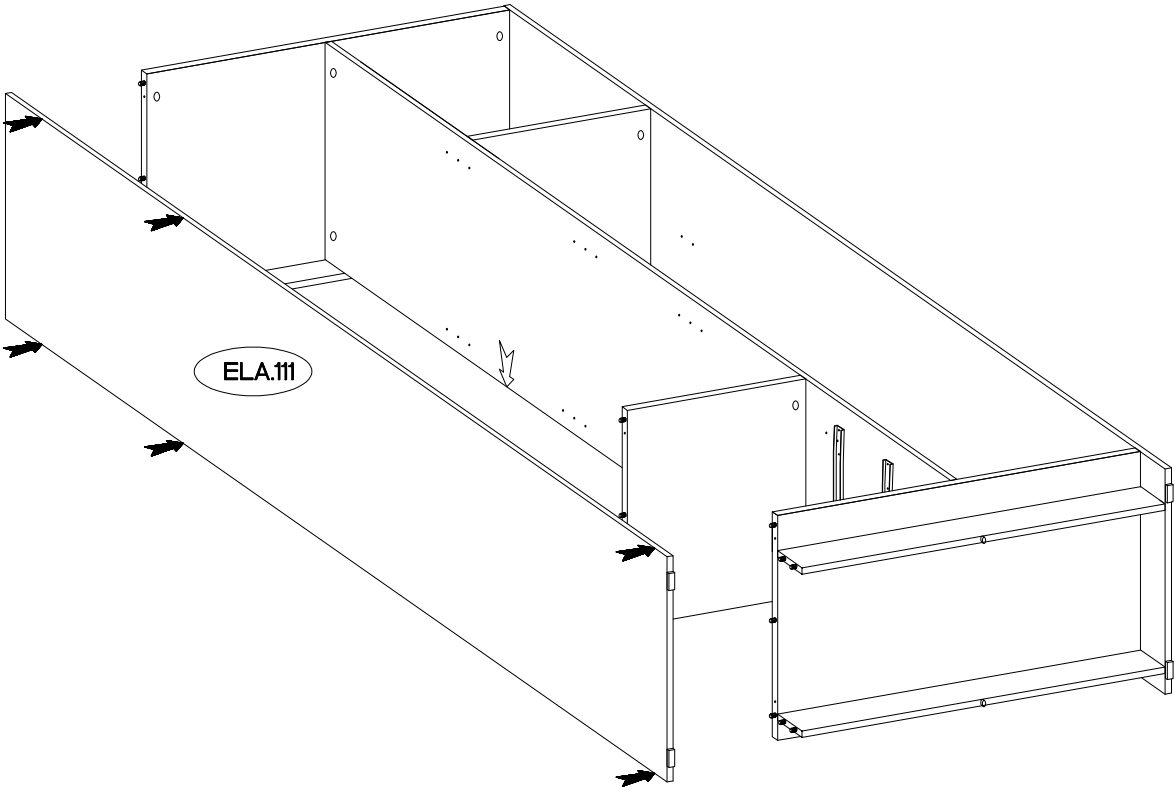
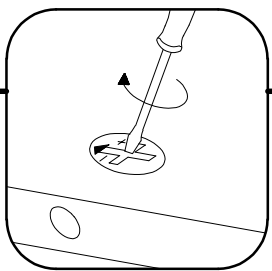
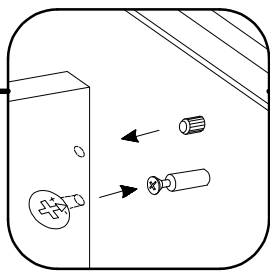

±3.0x20mm



P7



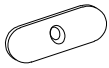

45-50



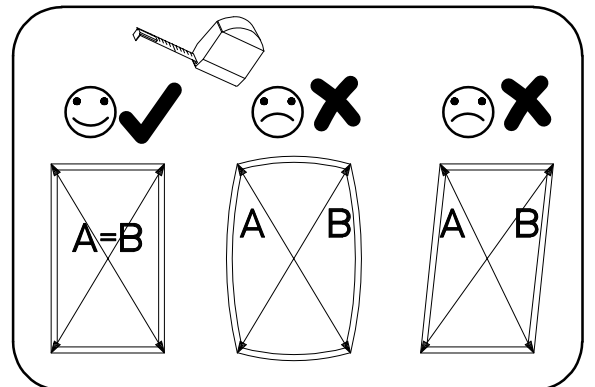
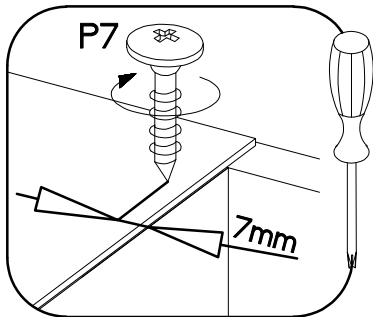
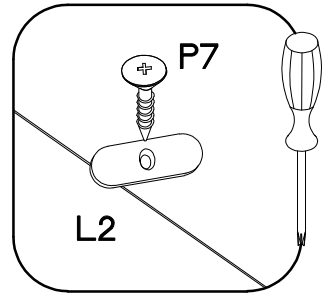
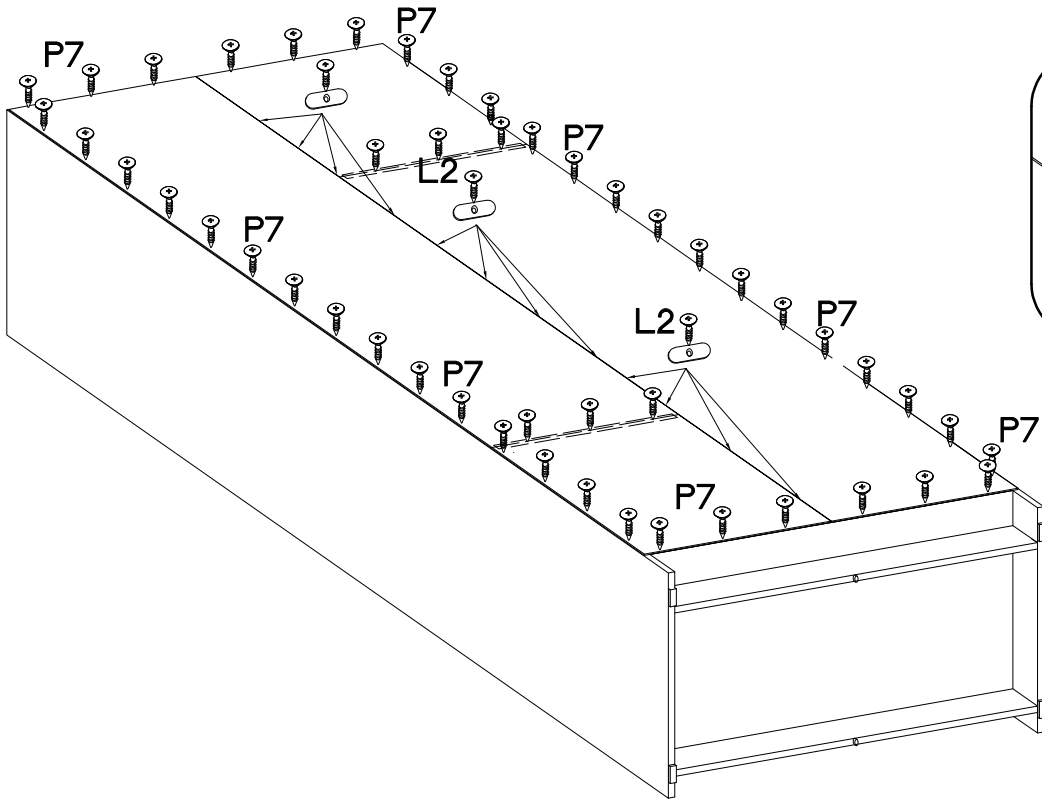
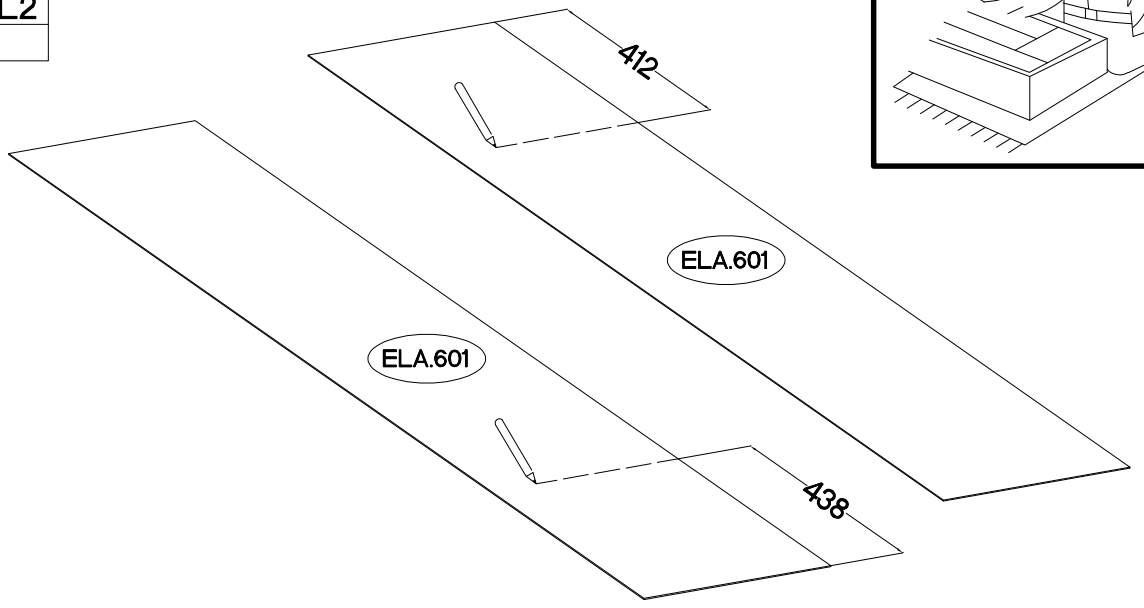
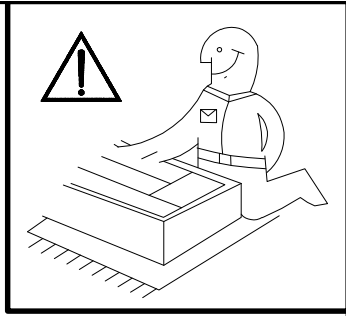

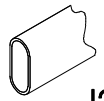

L2

12

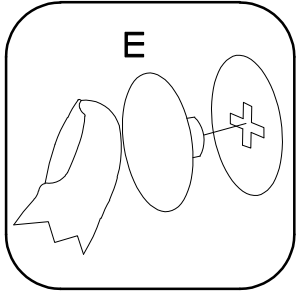
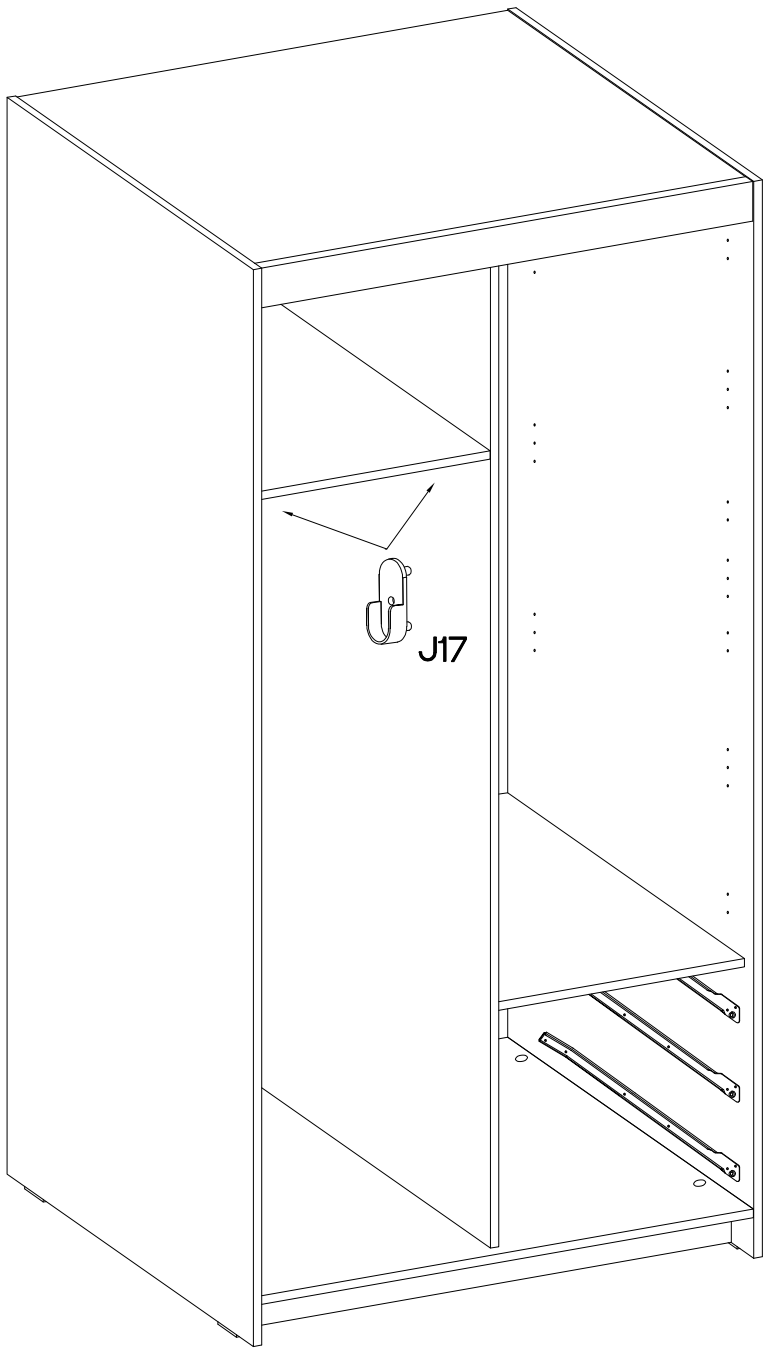
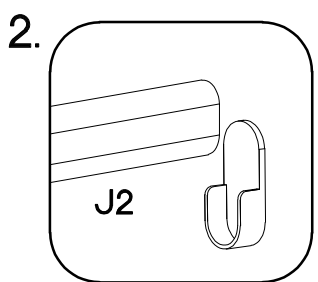
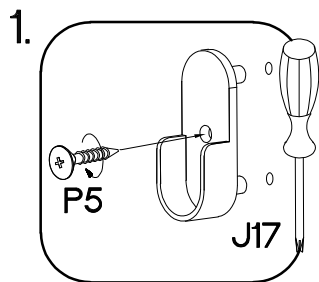

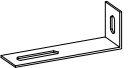

L=418mm  J2 1	 J17 2	φ3.5x13mm  P5 2	 E 20
--	--	--	---

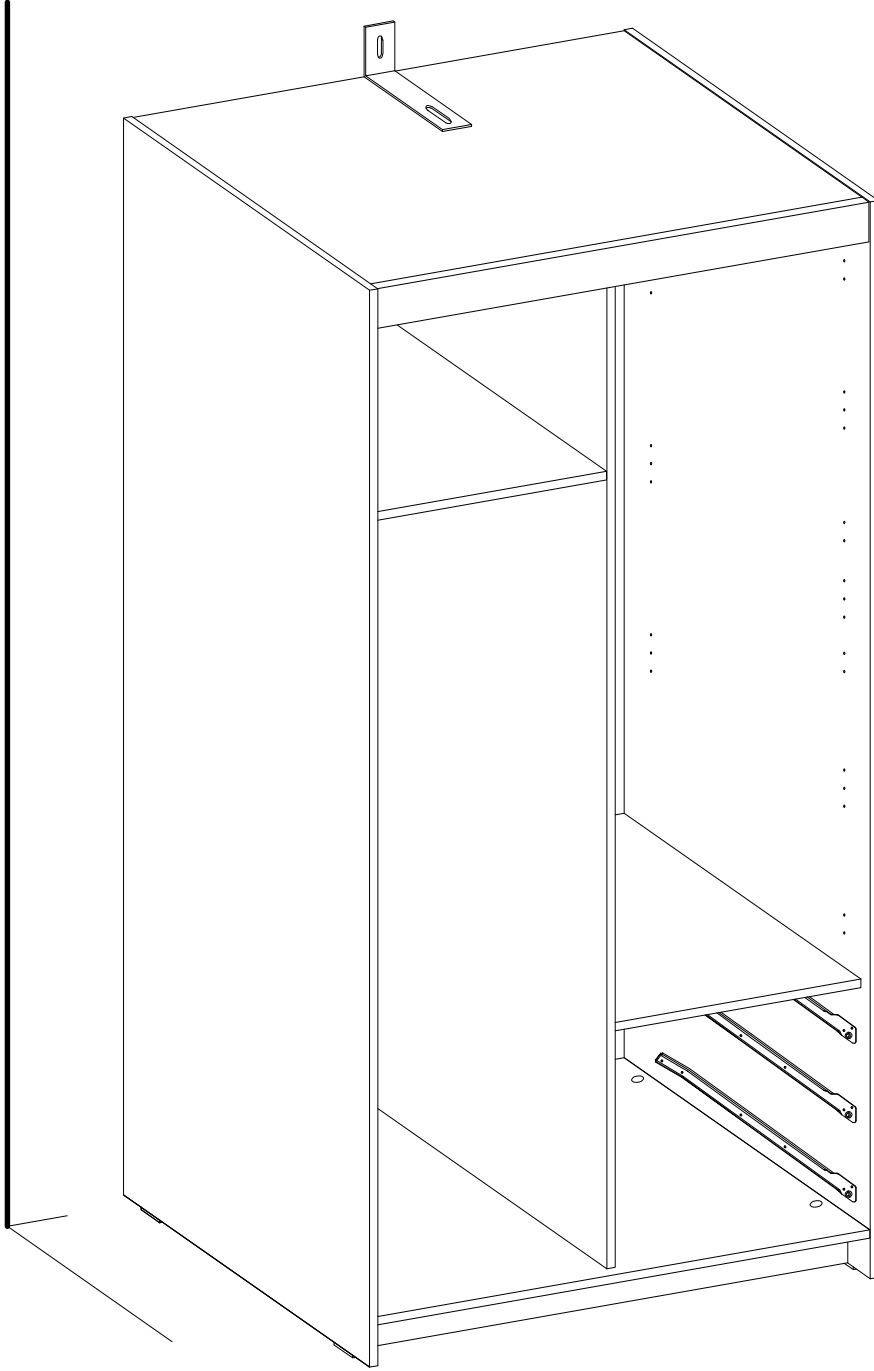
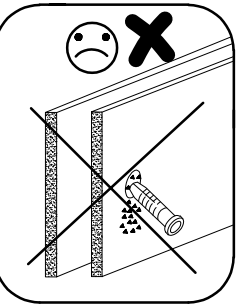
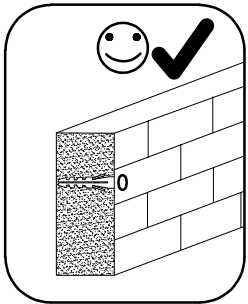
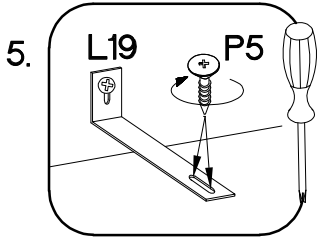
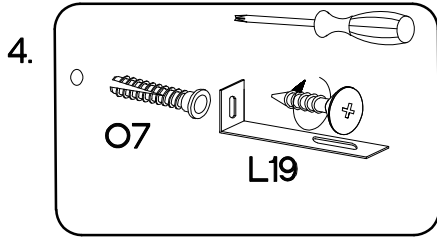
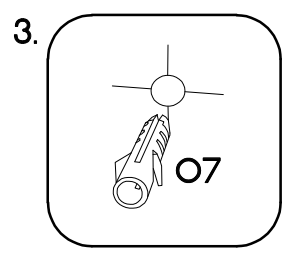
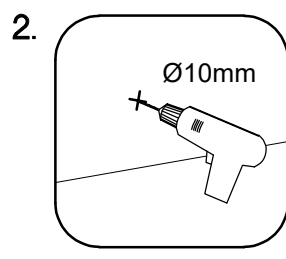
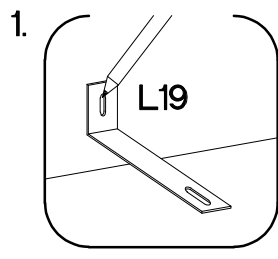

	†3.5x13mm	†5.0x60mm	†10x50mm
			
L19	P5	P12	O7
1	2	1	1

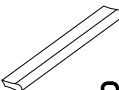

 +5/16mm J3	 L=128mm S	 +4.0x30mm R2
12	3	6

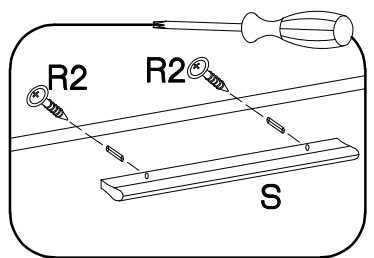
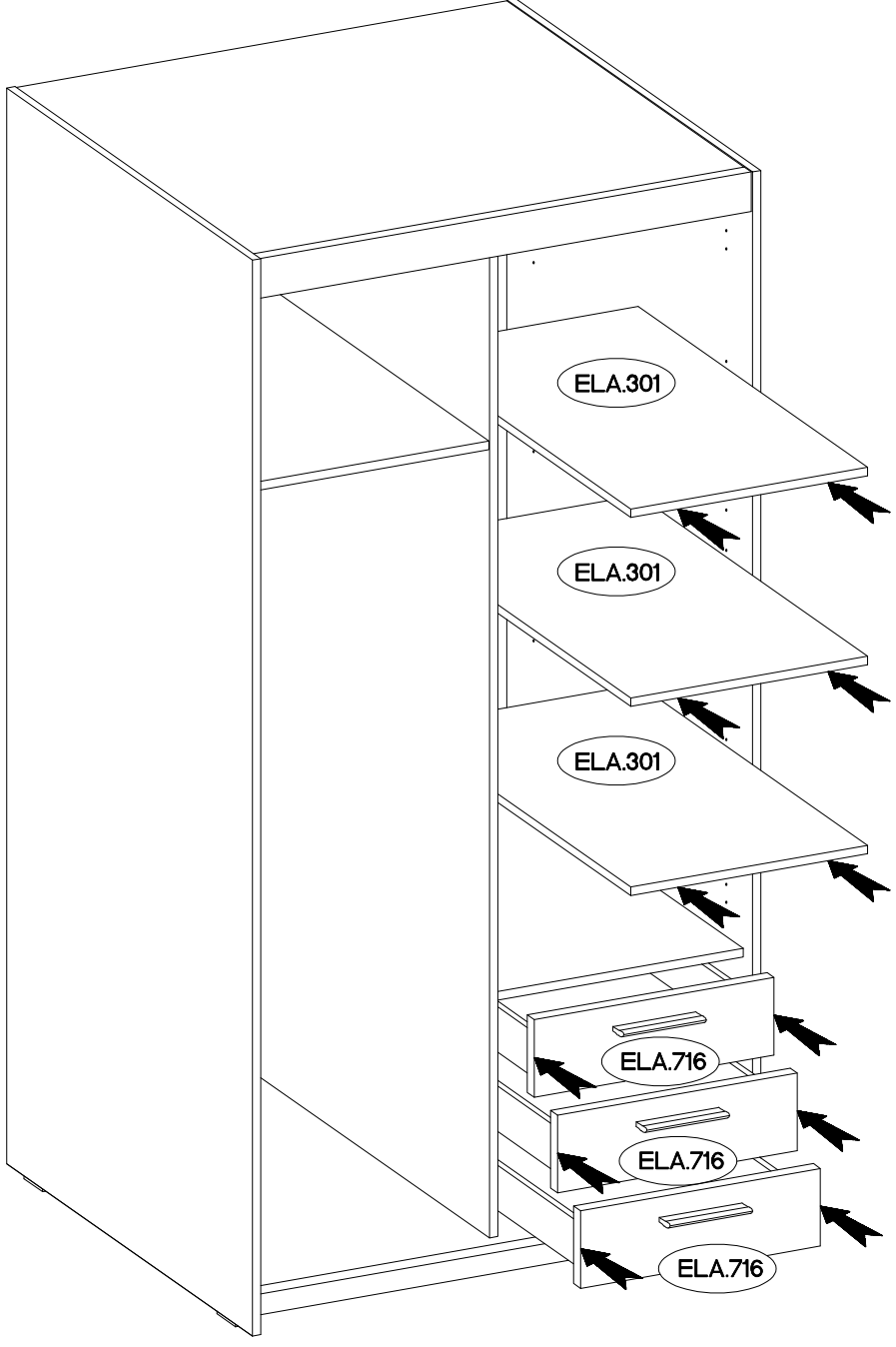
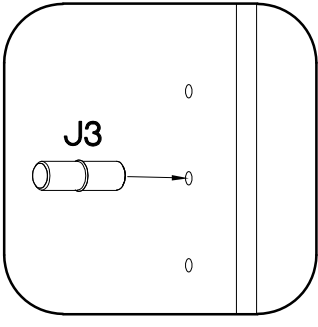

18

±35/16mm	±3.5x13mm
HG2	P5
6	12

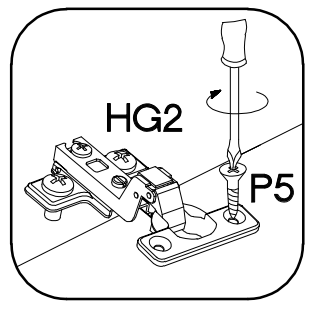
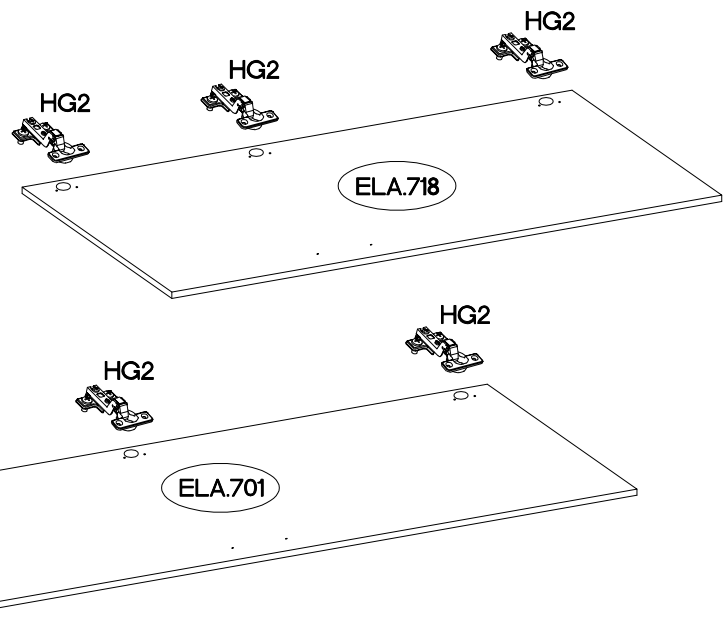

19

L=128mm	±4.0x30mm
S	R2
2	4

