

50 G-72 1F

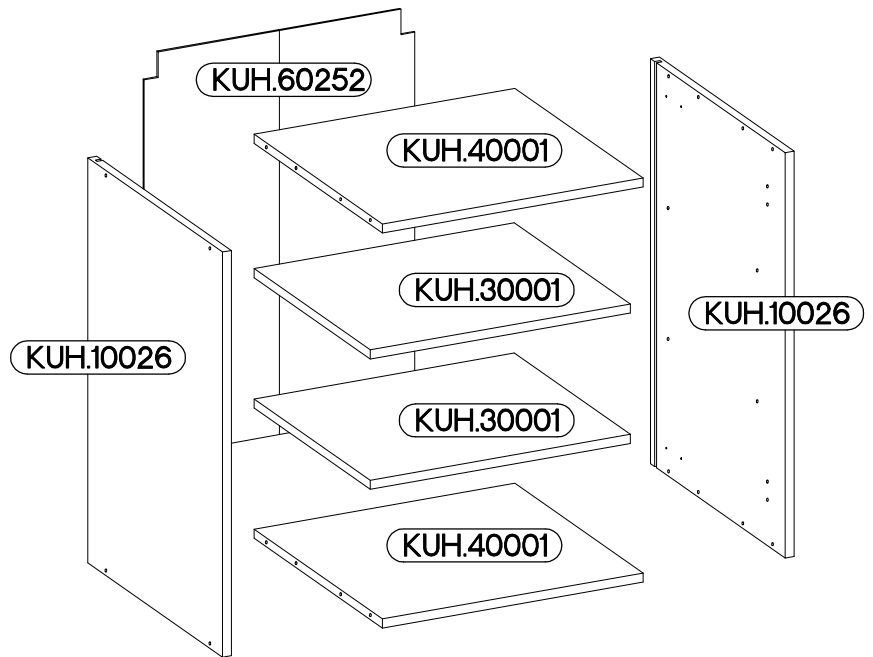

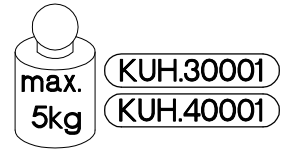

<p>±8x30mm</p> <p>A</p> <p>8</p>	<p>6,4 x 50mm</p> <p>B</p> <p>8</p>	<p>±35/0mm</p> <p>E1</p> <p>HG</p> <p>8</p> <p>2</p>			
<p>±5/19mm</p> <p>J</p> <p>8</p>	<p>K</p> <p>2</p>	<p>O</p> <p>1</p>	<p>±3.5x13mm</p> <p>P5</p> <p>4</p>	<p>±3.0x20mm</p> <p>P7</p> <p>8-10</p>	<p>±4.0x30mm</p> <p>P8</p> <p>4</p>

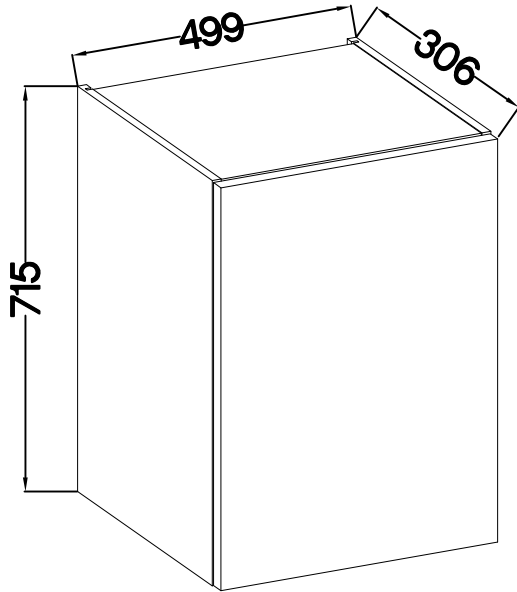
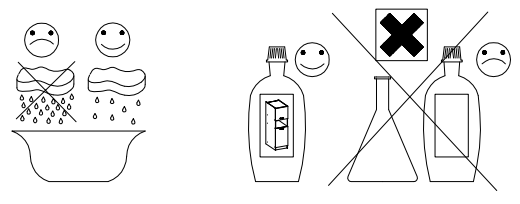
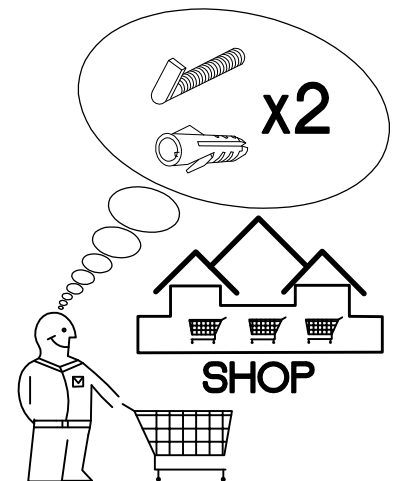

ISM-KUH-01617

1

$\pm 8 \times 30 \text{mm}$  A 8	$\pm 4.0 \times 30 \text{mm}$  P8 4	 K 2
---------------------------------------------------------------------------------------------------------------------------	------------------------------------------------------------------------------------------------------------------------------	--------------------------------------------------------------------------------------------

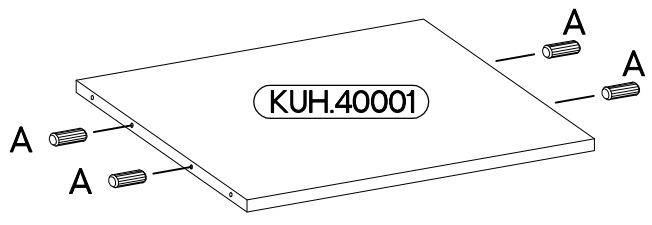
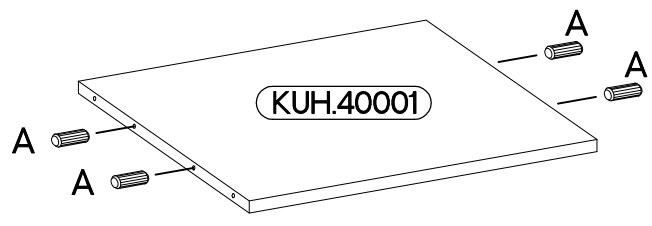
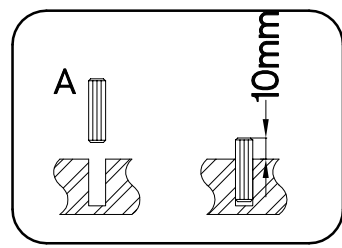
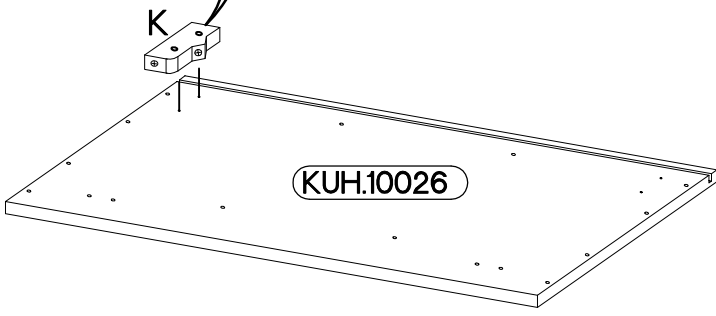
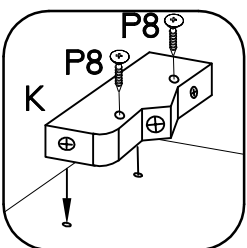
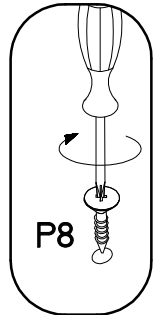
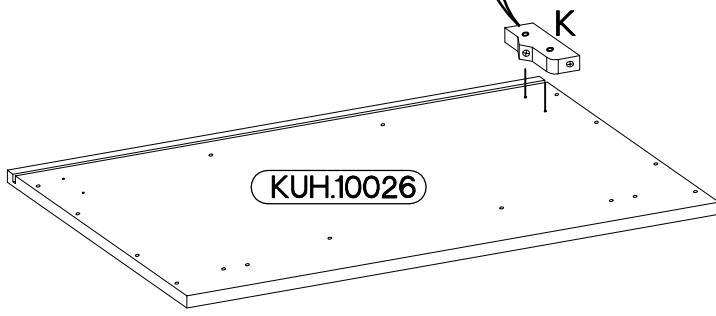
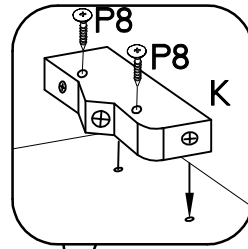
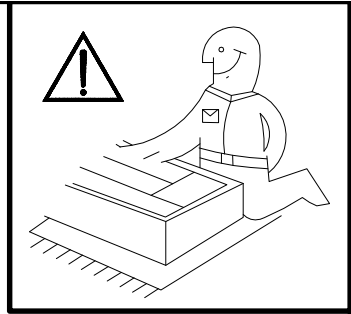

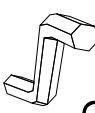
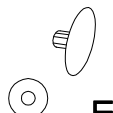

2

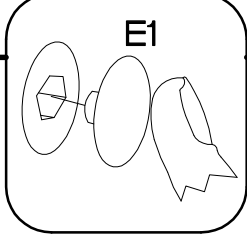
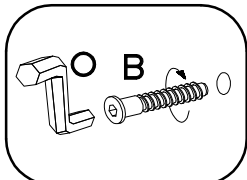
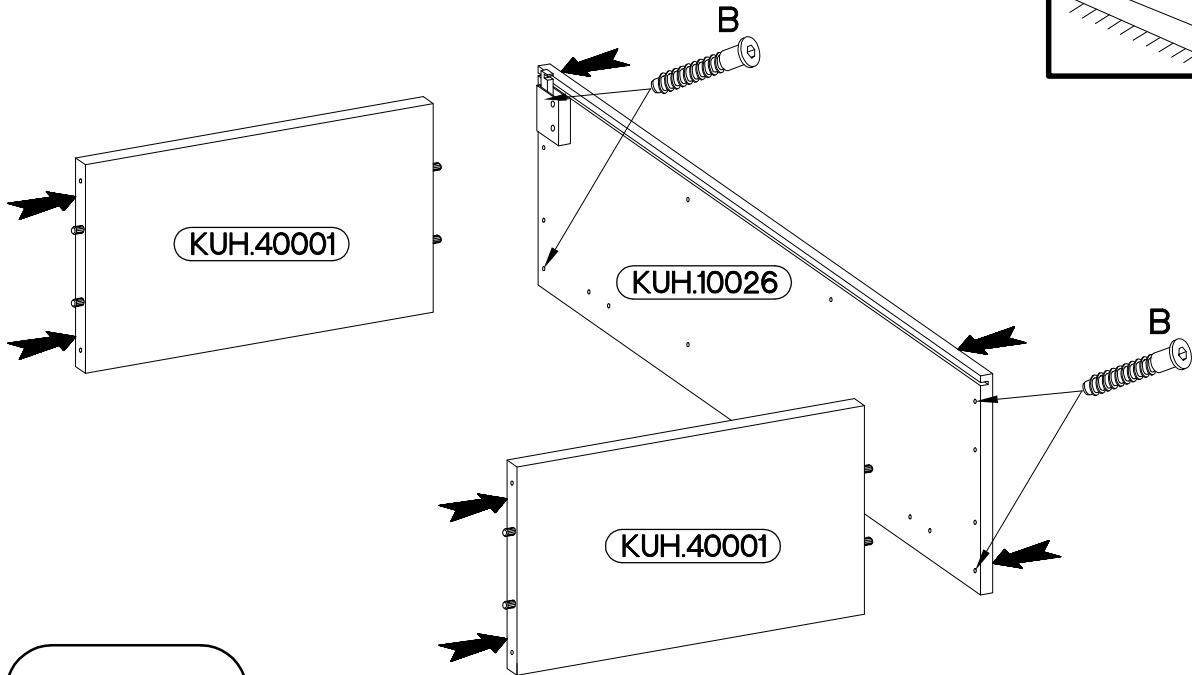
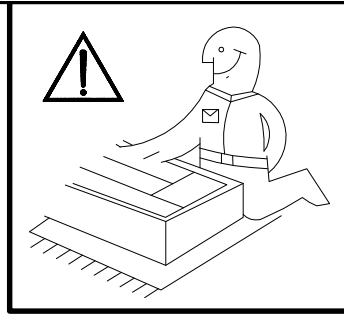
6,4 x 50mm		
		
B	O	E1
4	1	4

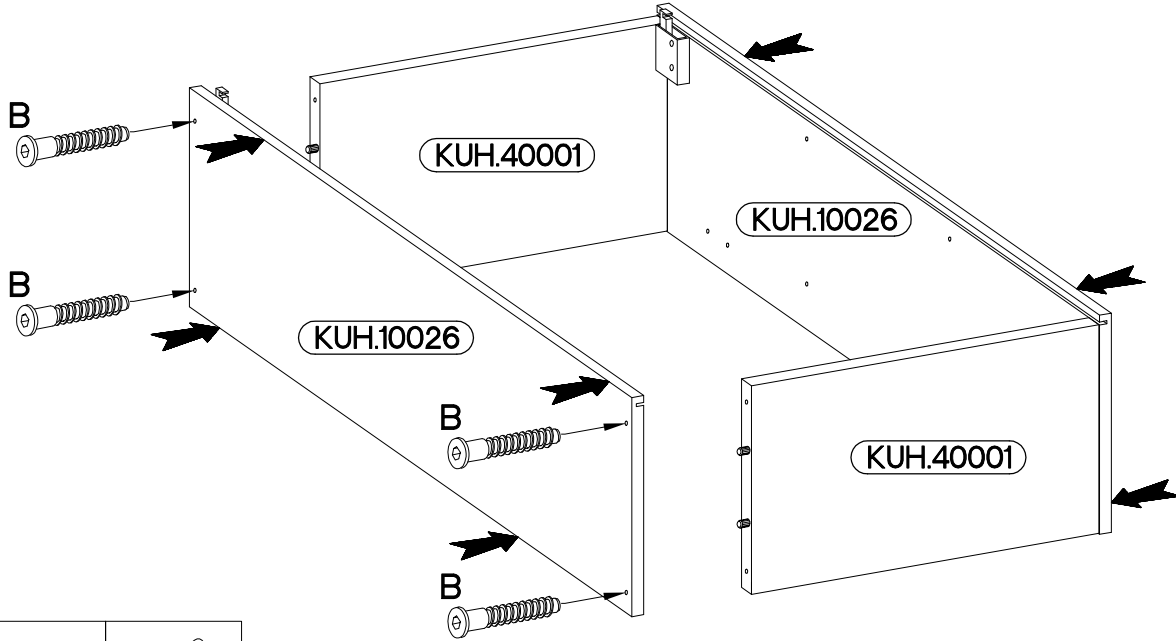

3

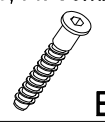

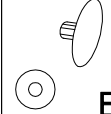
6,4 x 50mm		
		
B	O	E1
4	1	4

4

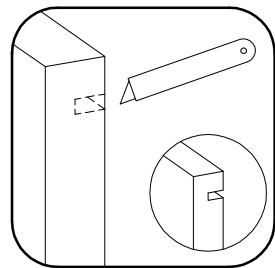
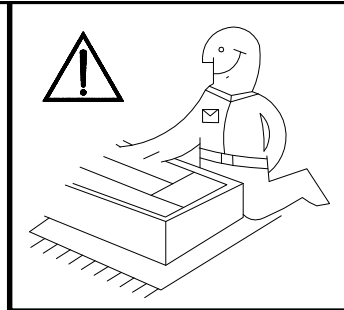
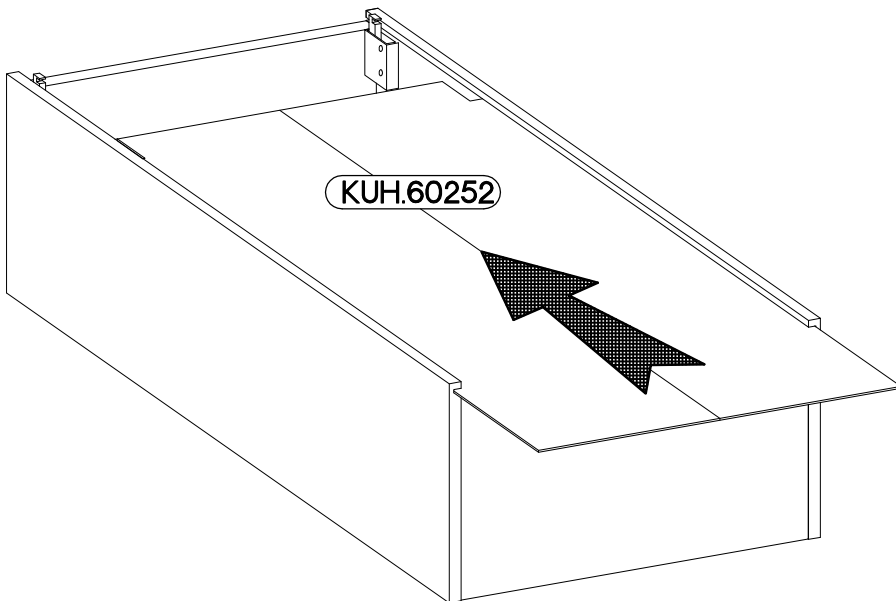

5

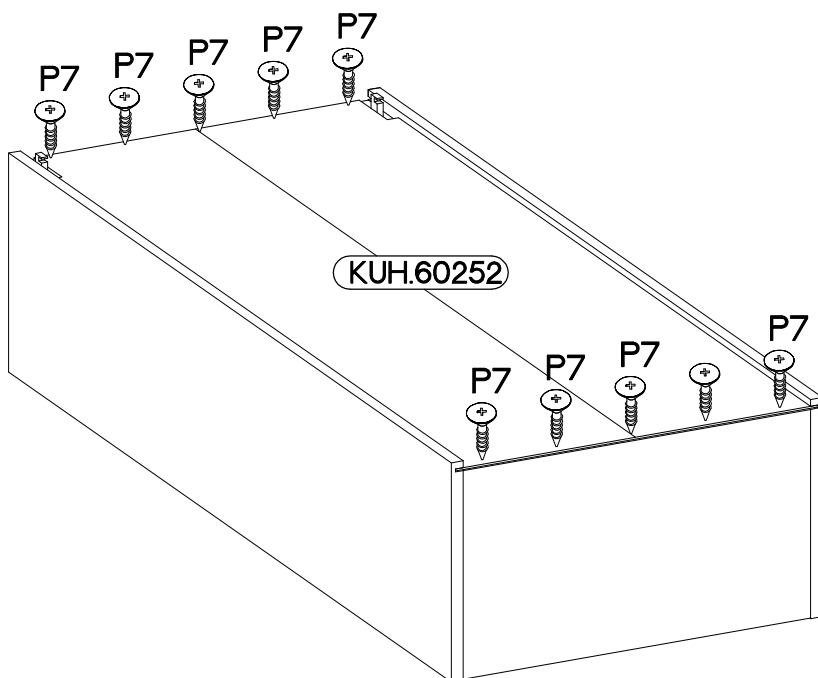
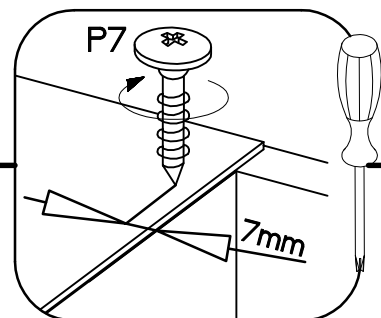
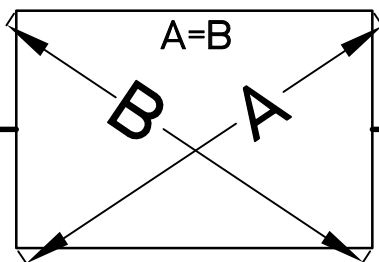
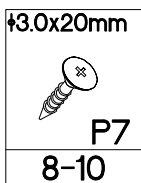

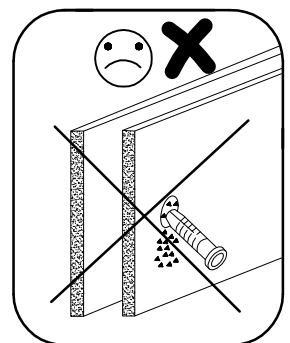
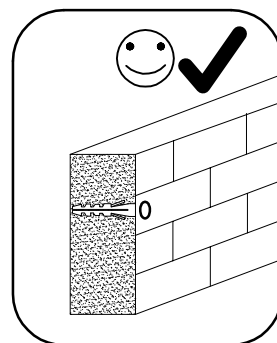
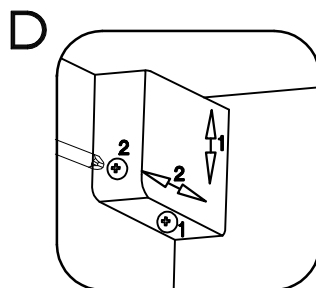
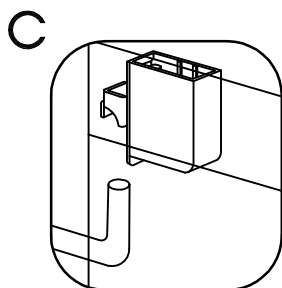
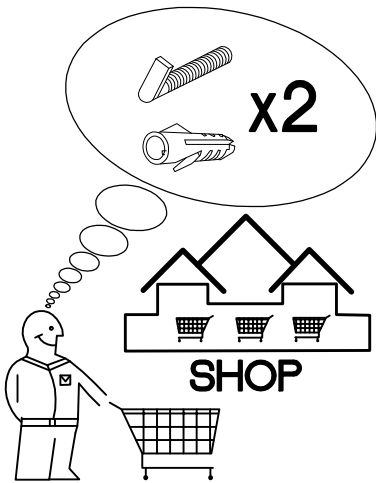
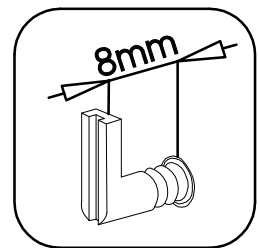
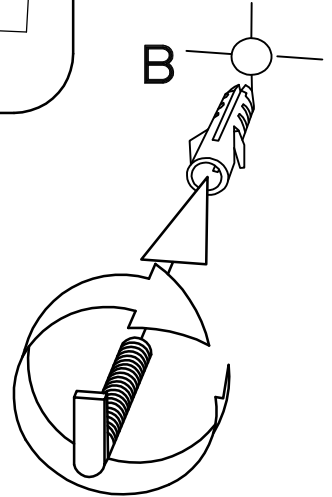
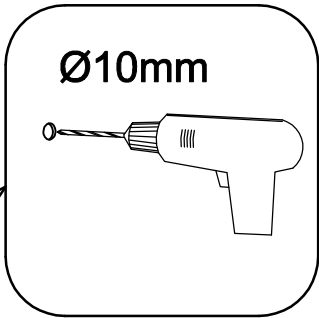
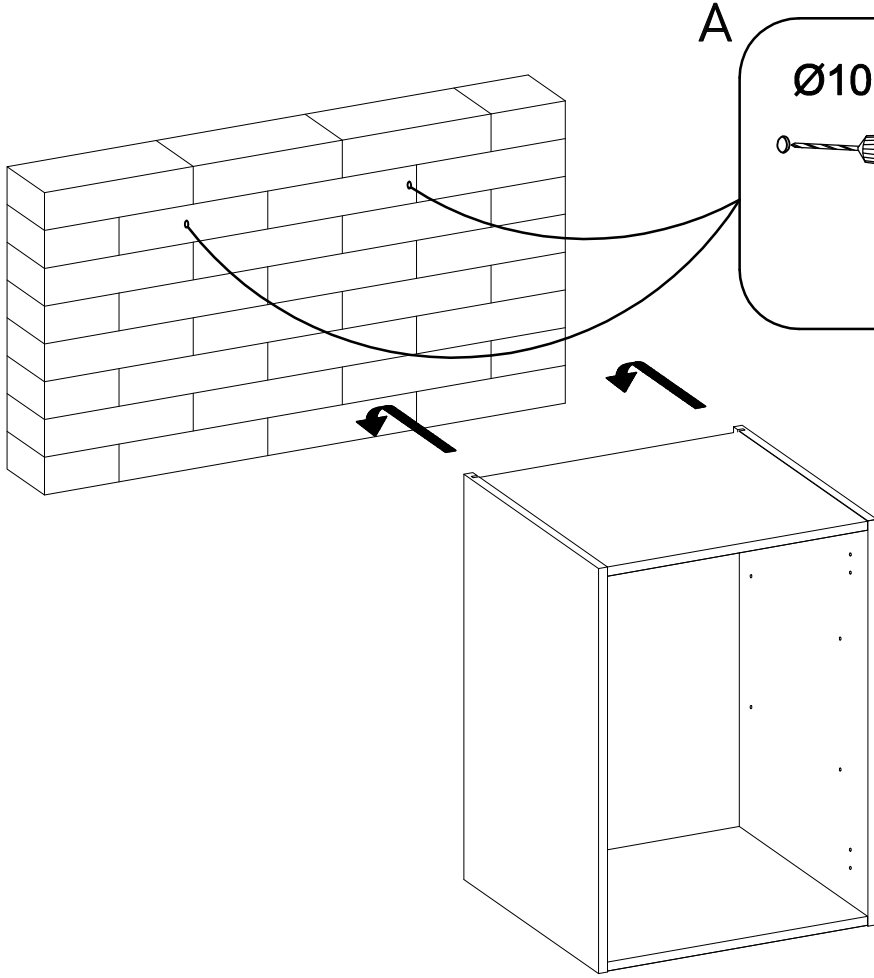
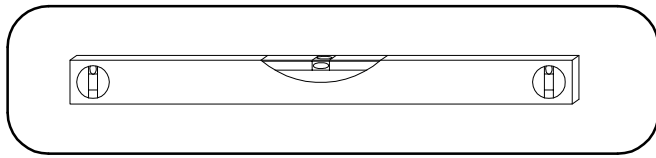

7

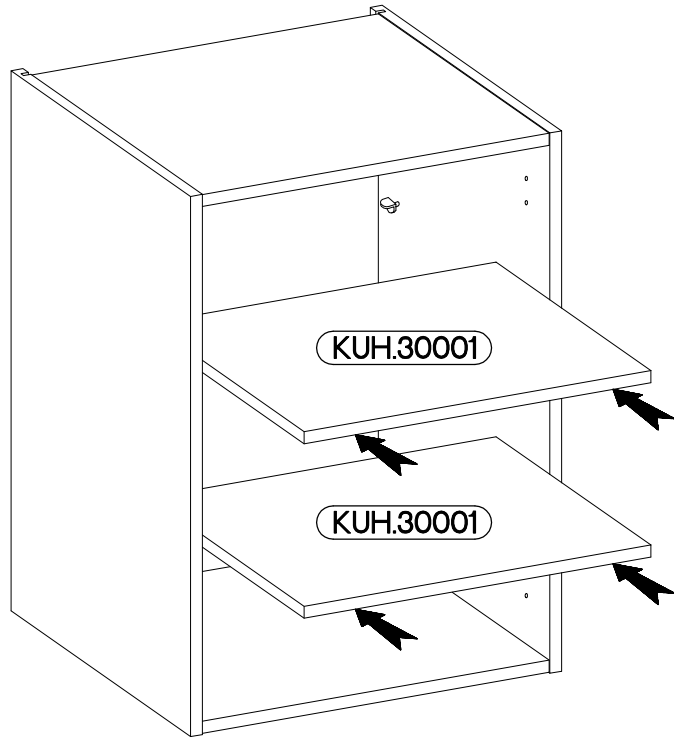
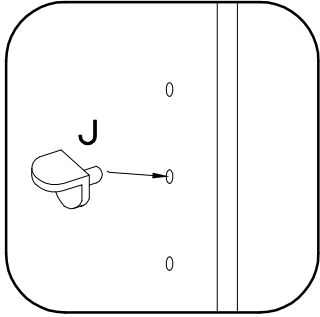
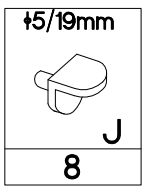

8

FRONT

