

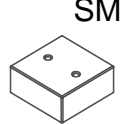





8x30 D 20	A 20	B 28	S 12	8x45 D1 2	H 32	4x30 H3 12	SM 6
X 28	L 16	Z 8	Z1 8	A1 4	UD 2	4x16 H1 40	UM 2

H3	SM	A
		
12	6	12

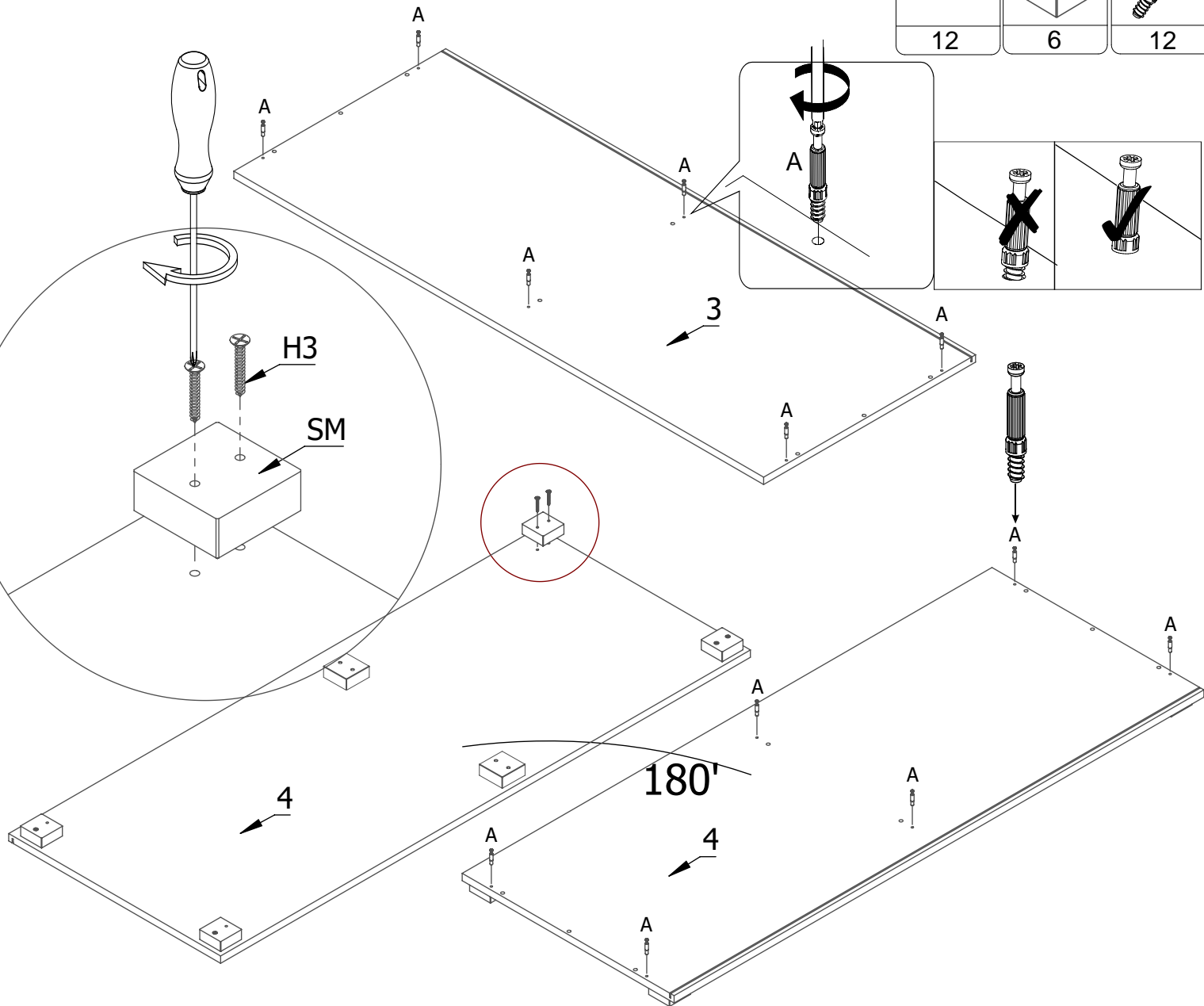

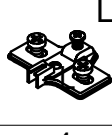
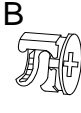
S	L	B	D	A
				
6	4	4	6	4

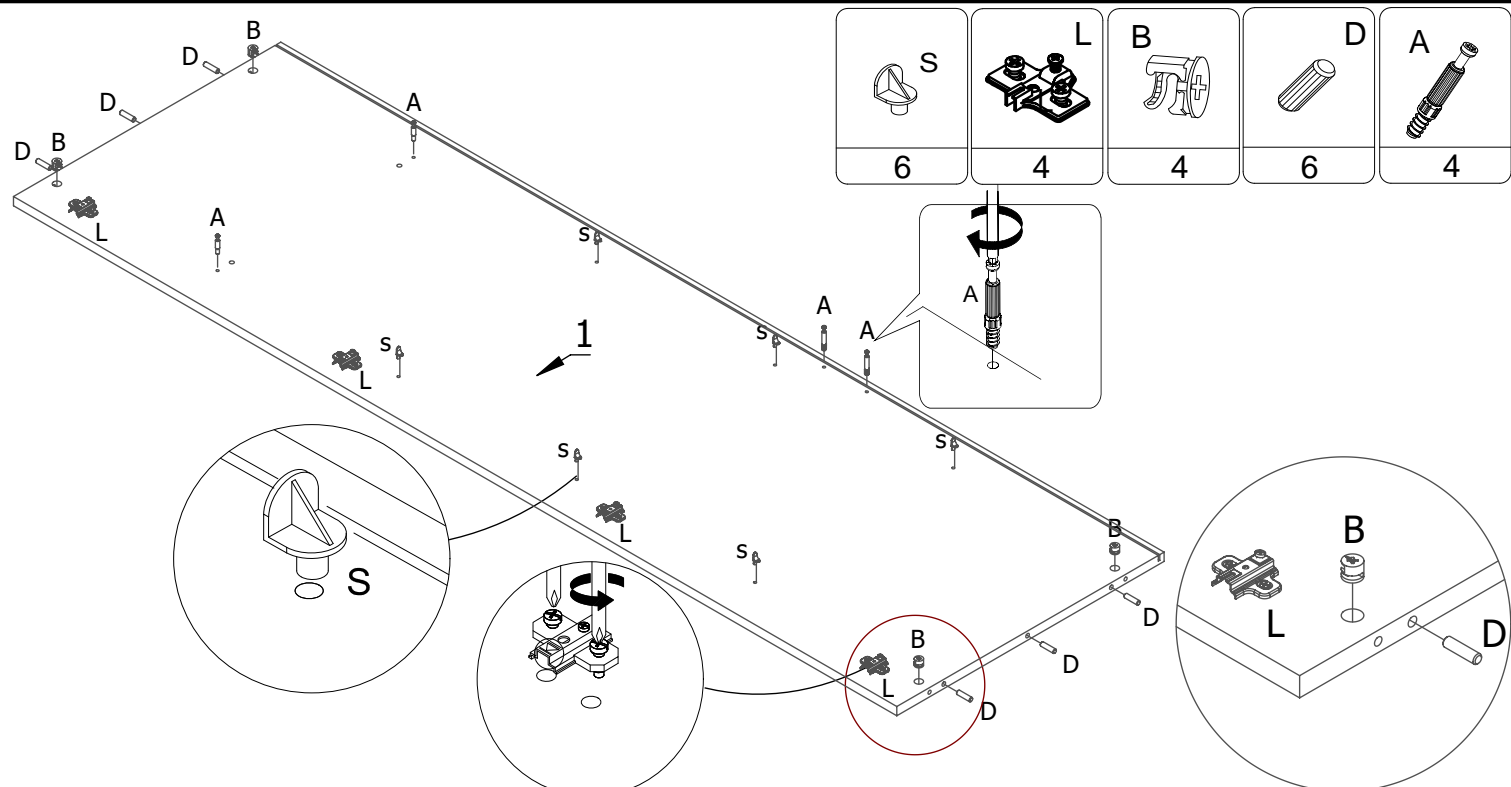

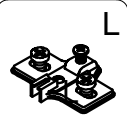
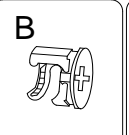
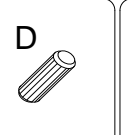
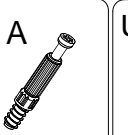
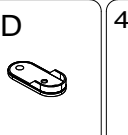
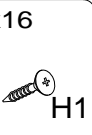
					
4	4	6	4	1	2

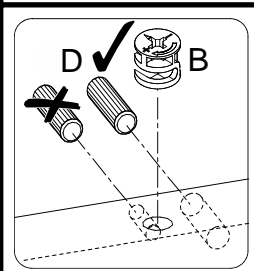
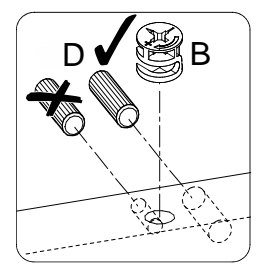
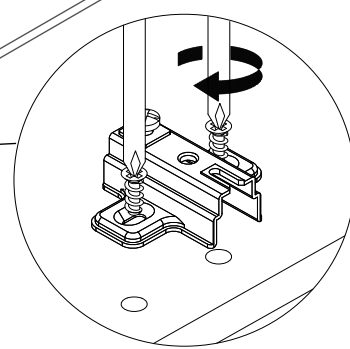
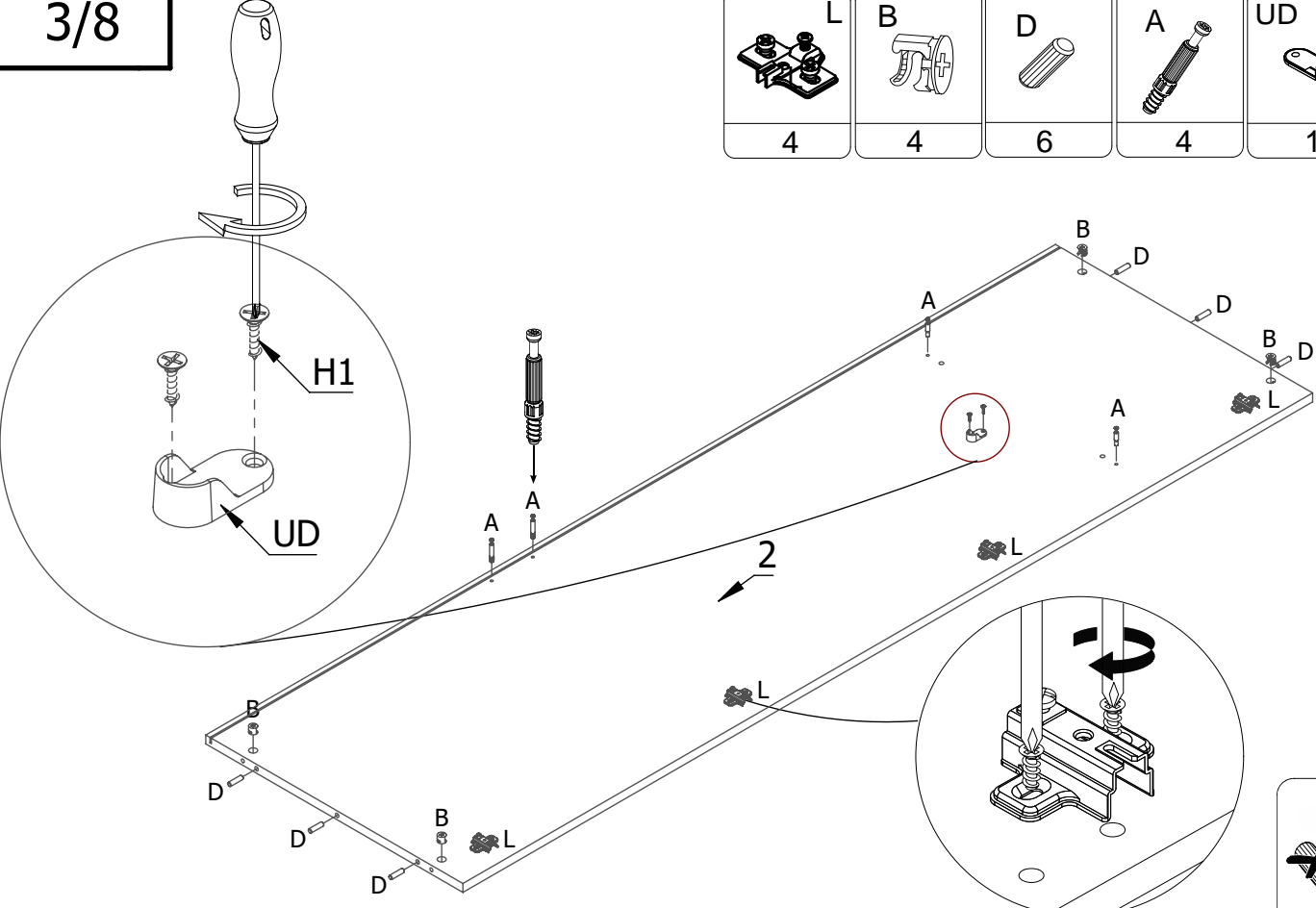

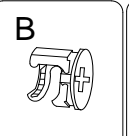
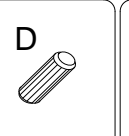
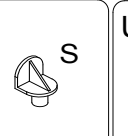
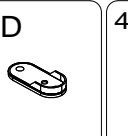
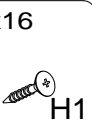
					
8	4	4	6	1	2

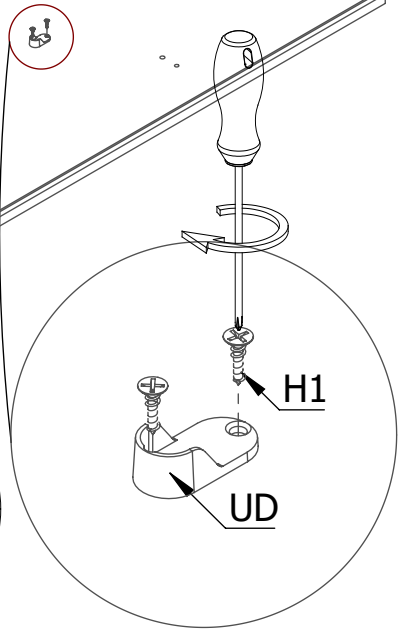
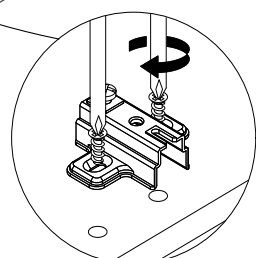
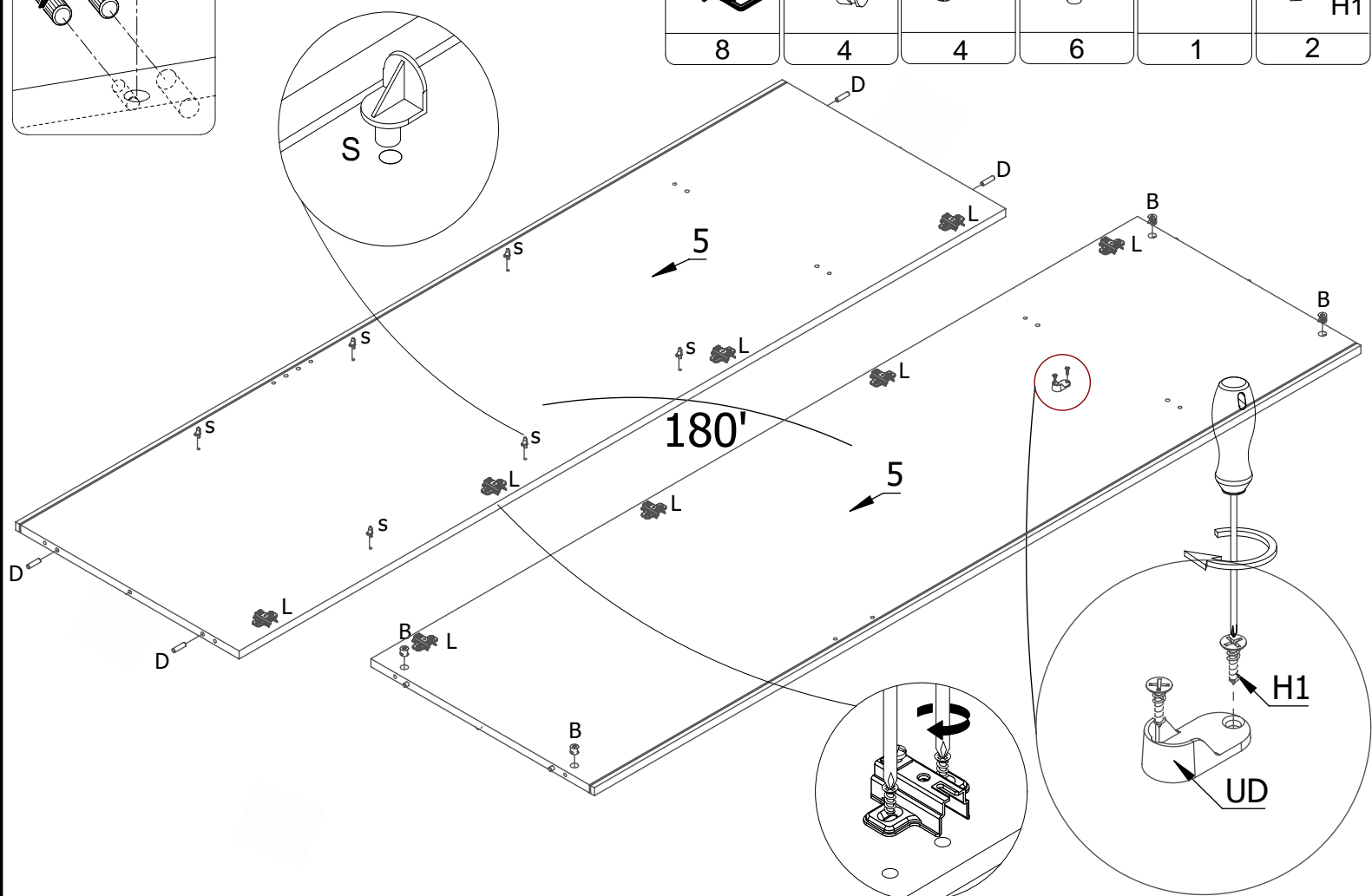

Z	Z1	4x16
8	8	H1 32

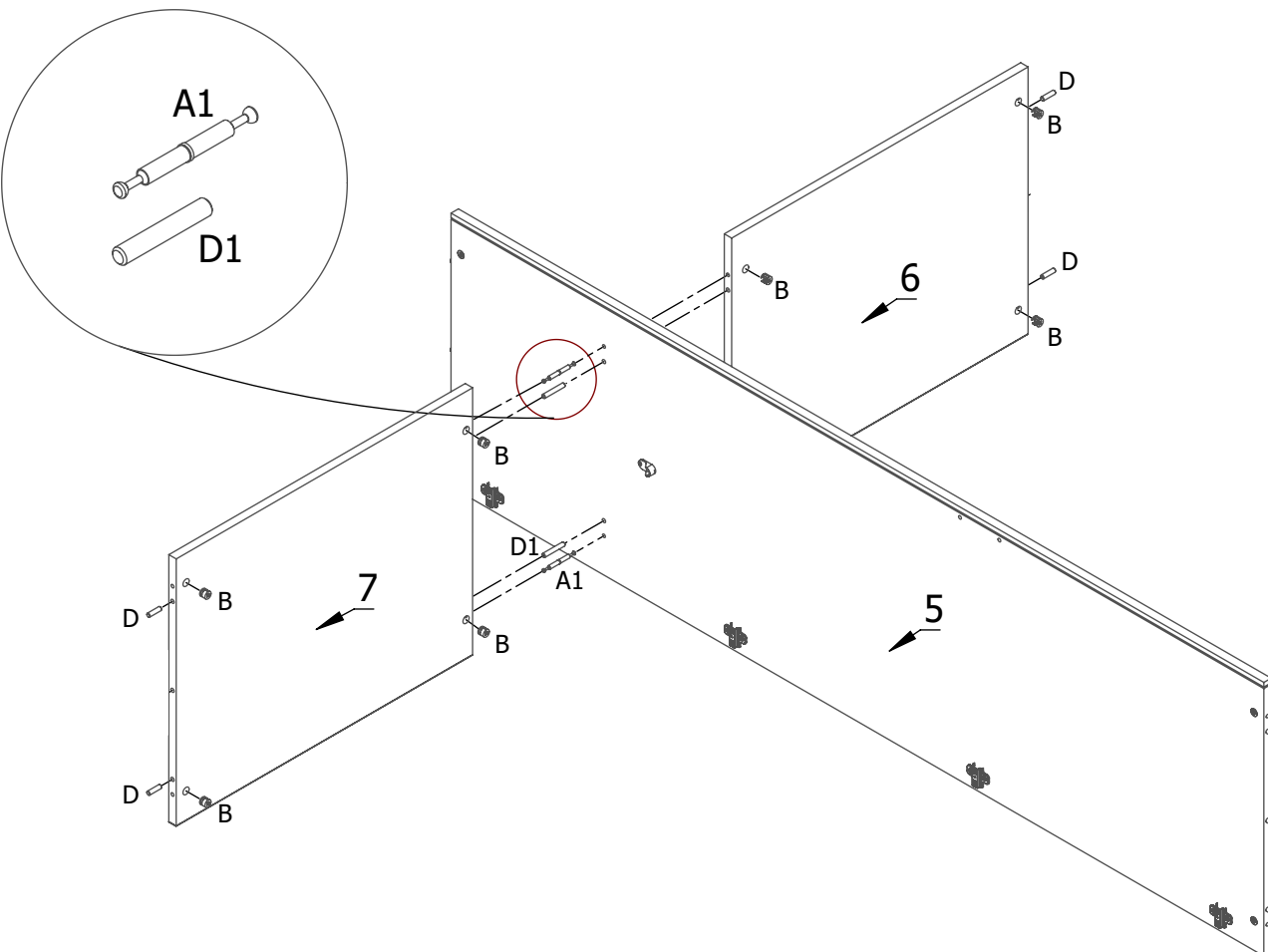
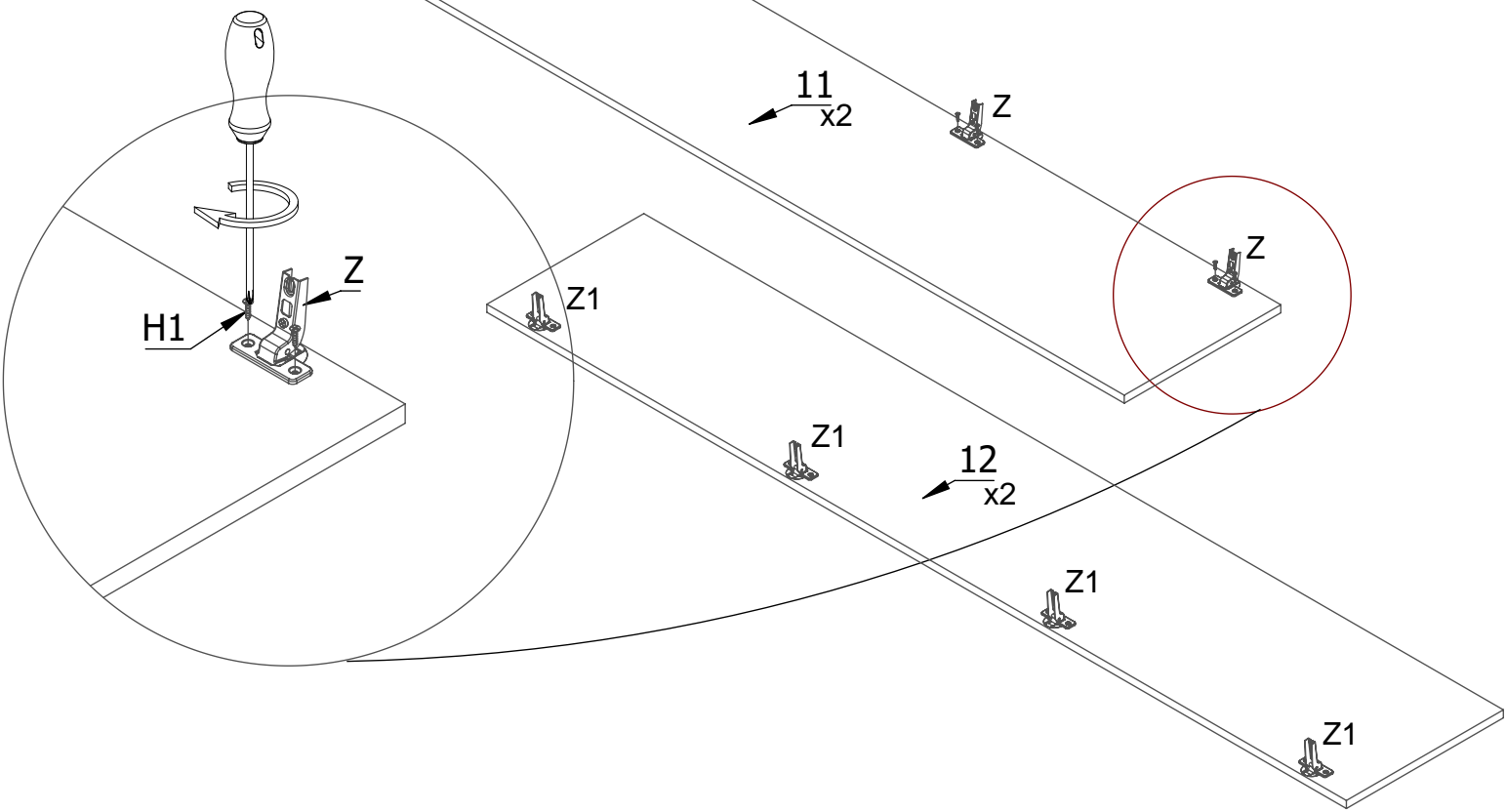

D	8.0x45
4	D1 2
A1	B
2	8

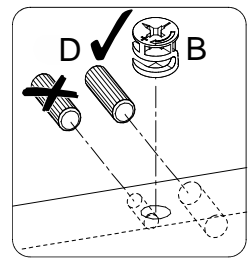

A1

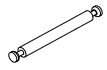

2

B



8

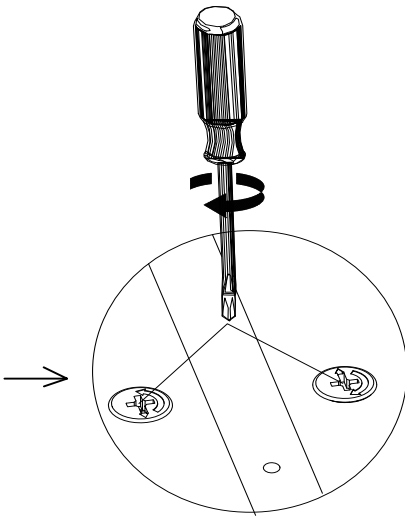
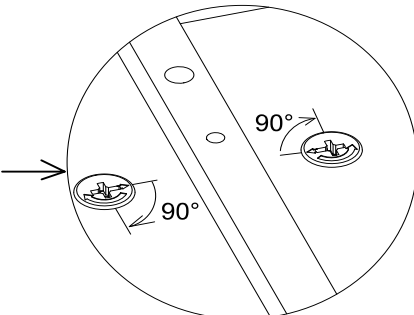
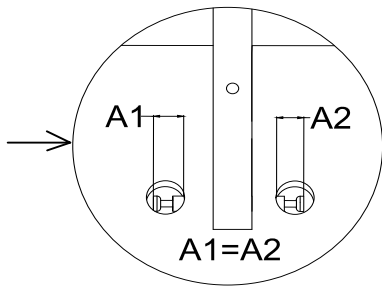
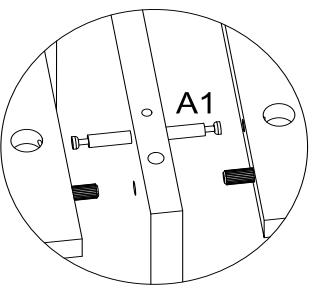
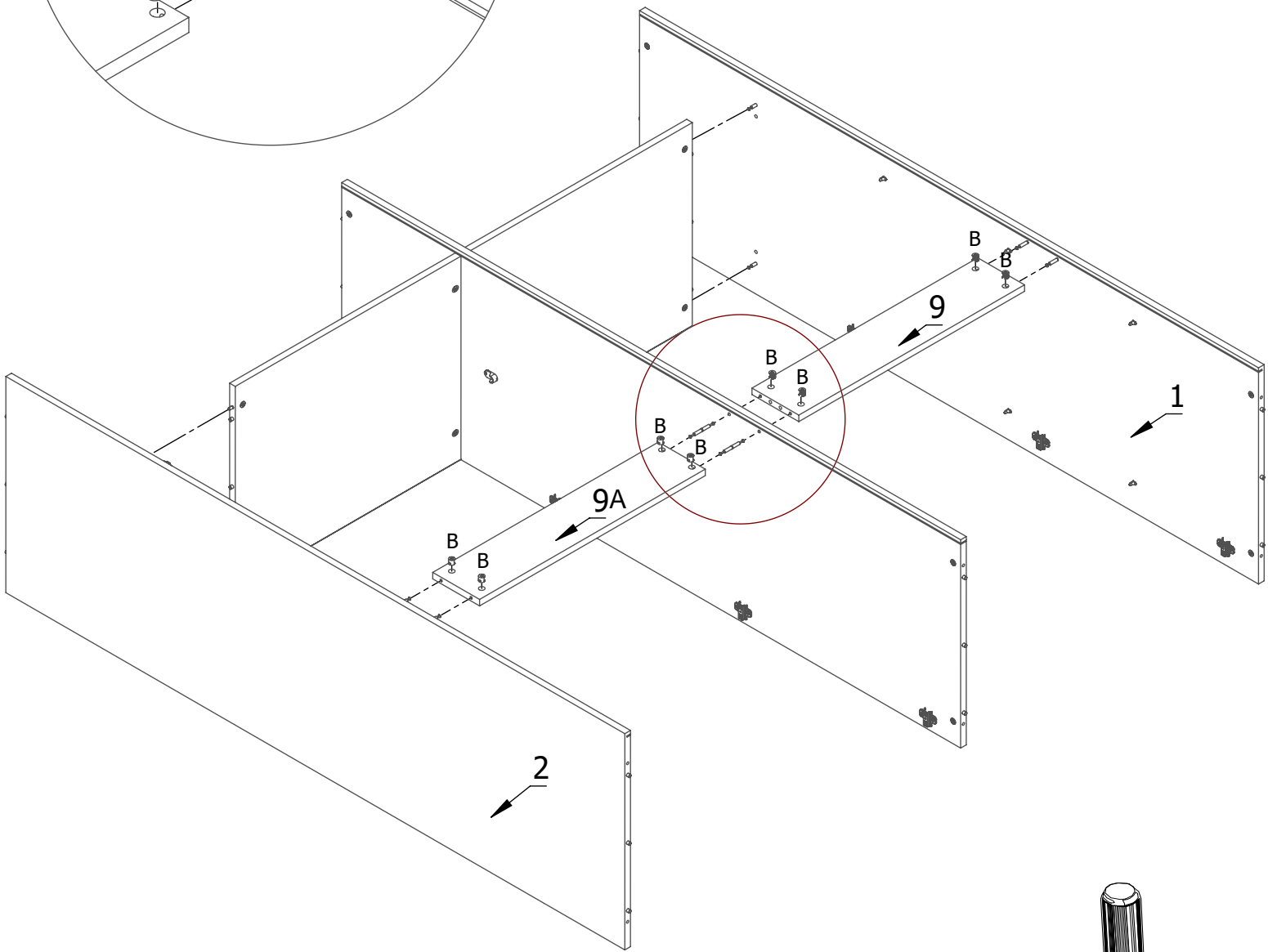
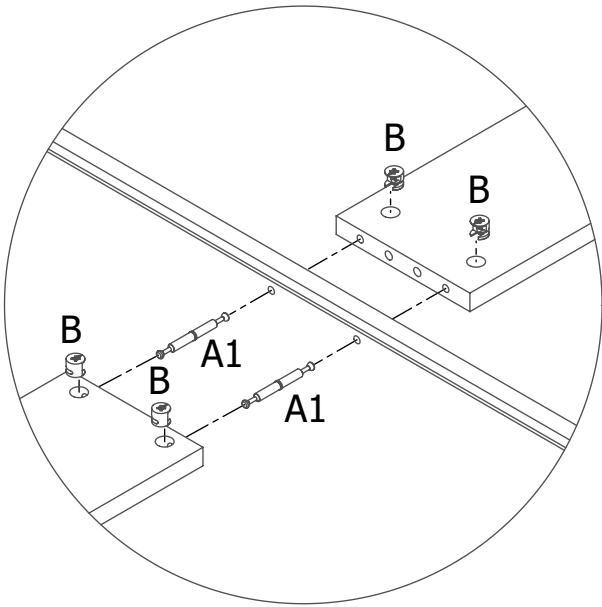

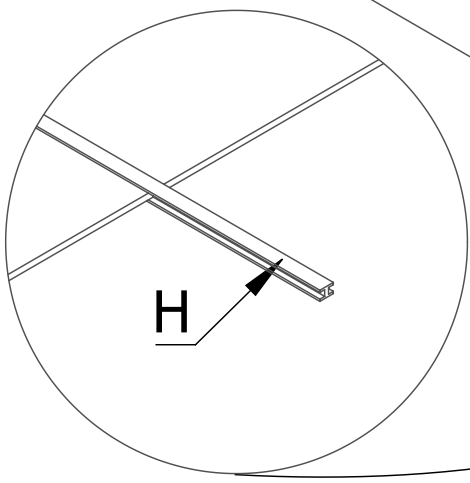
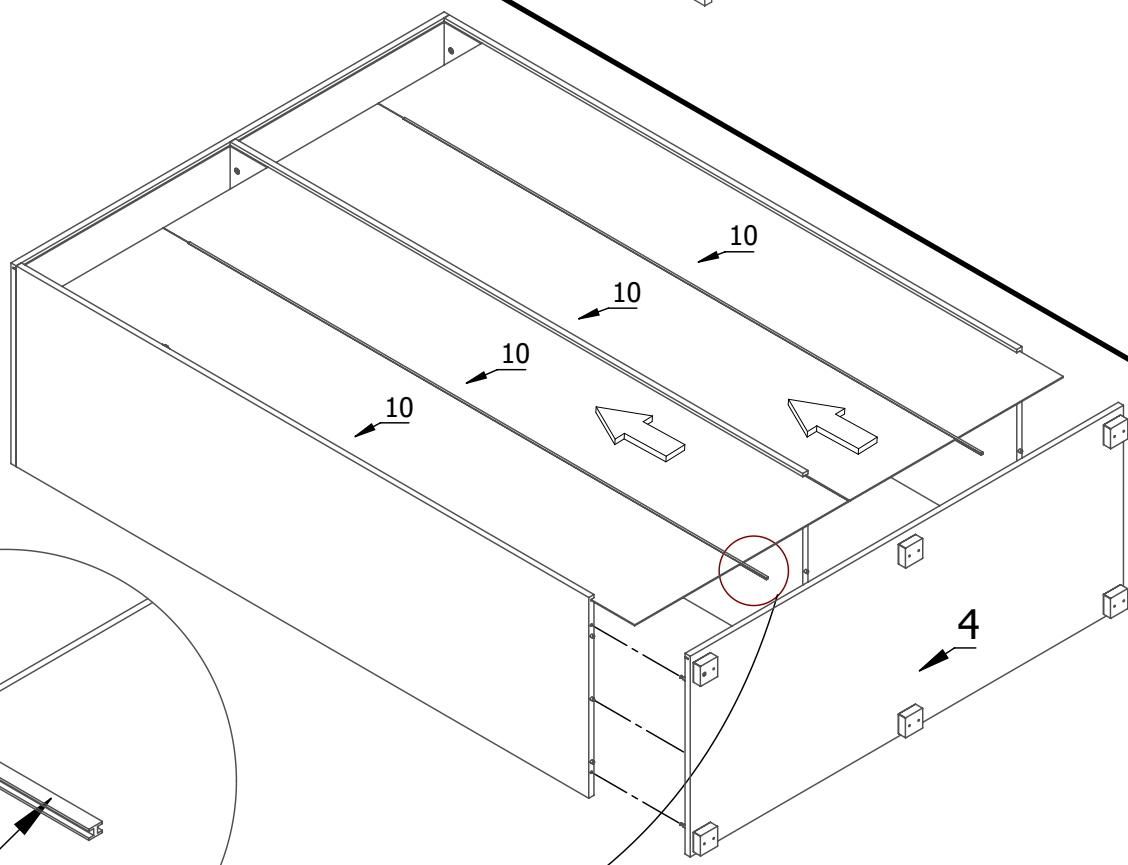
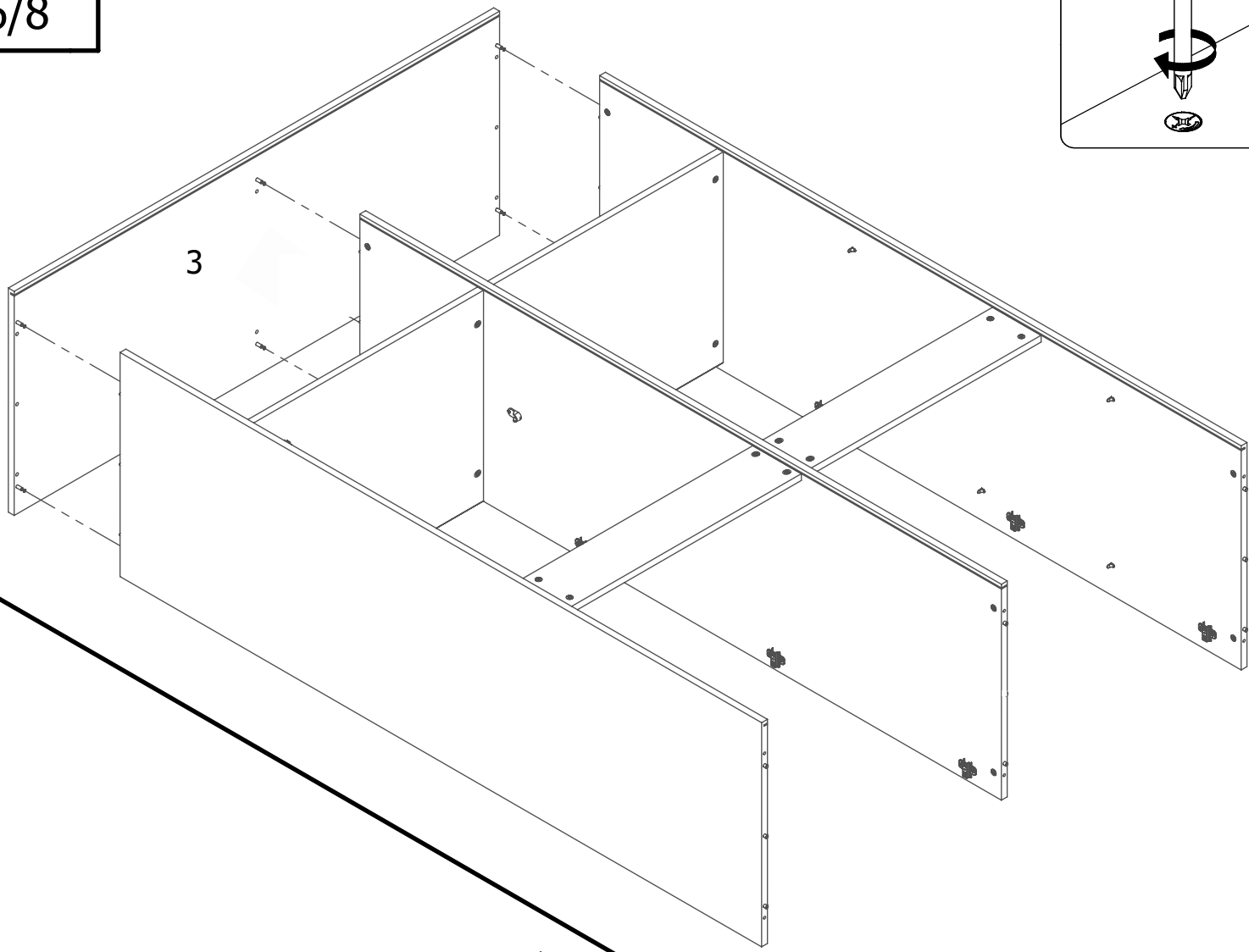
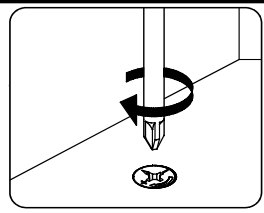

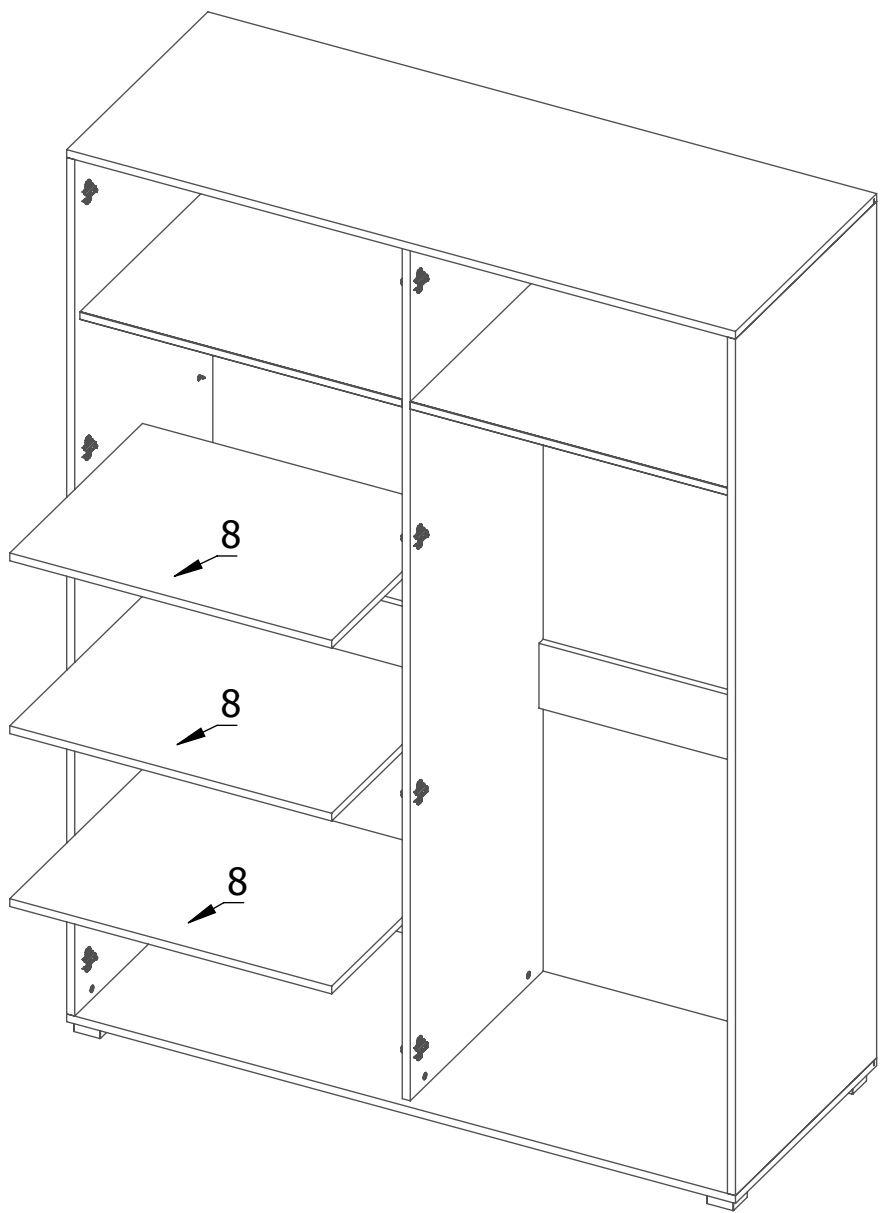
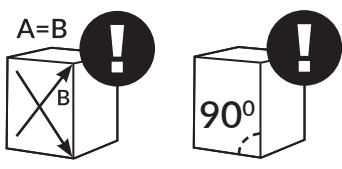
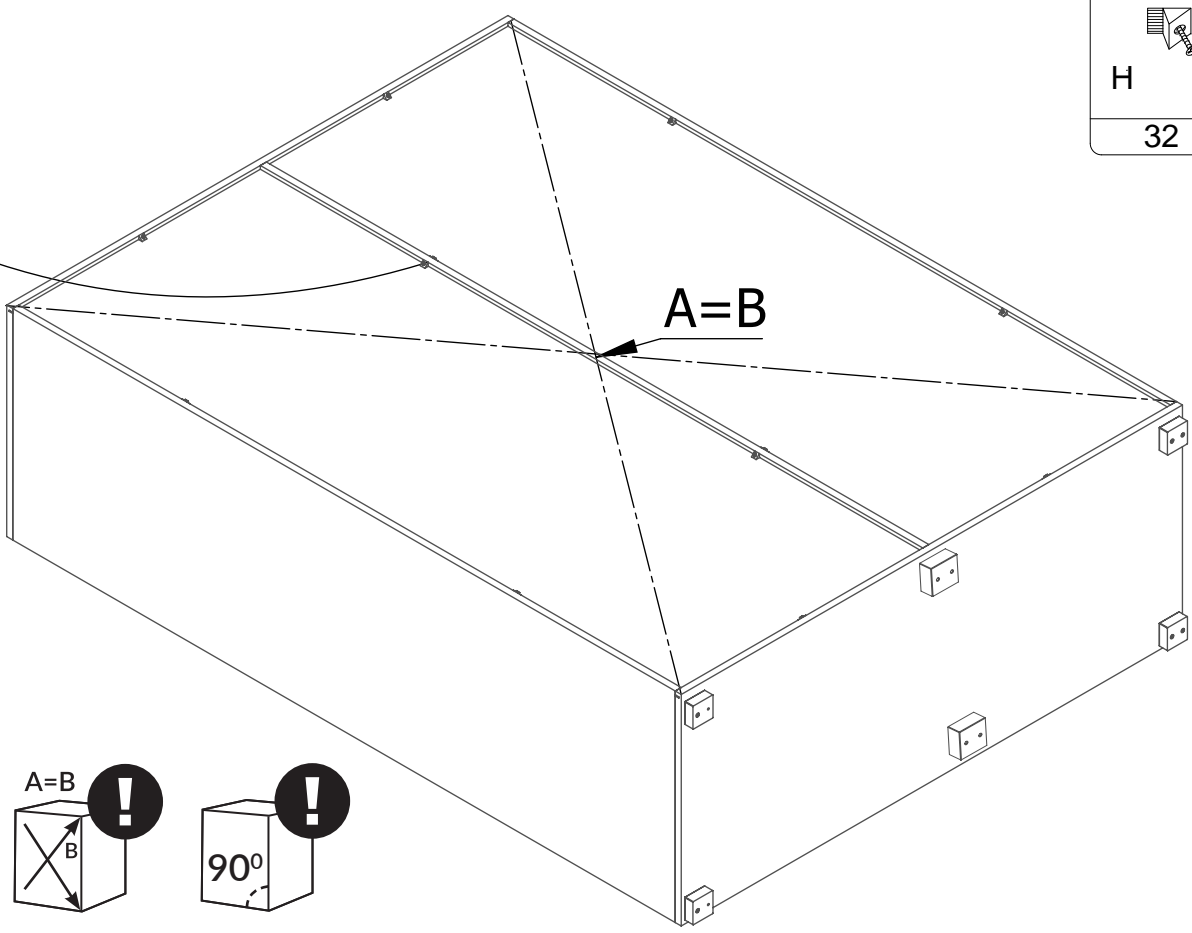
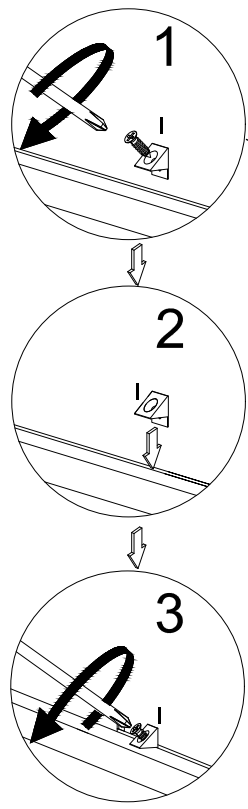

X ⊙	4x16 H1 ⌘	UM ⌘
20	4	2

