

KITCHEN 6D, 7D

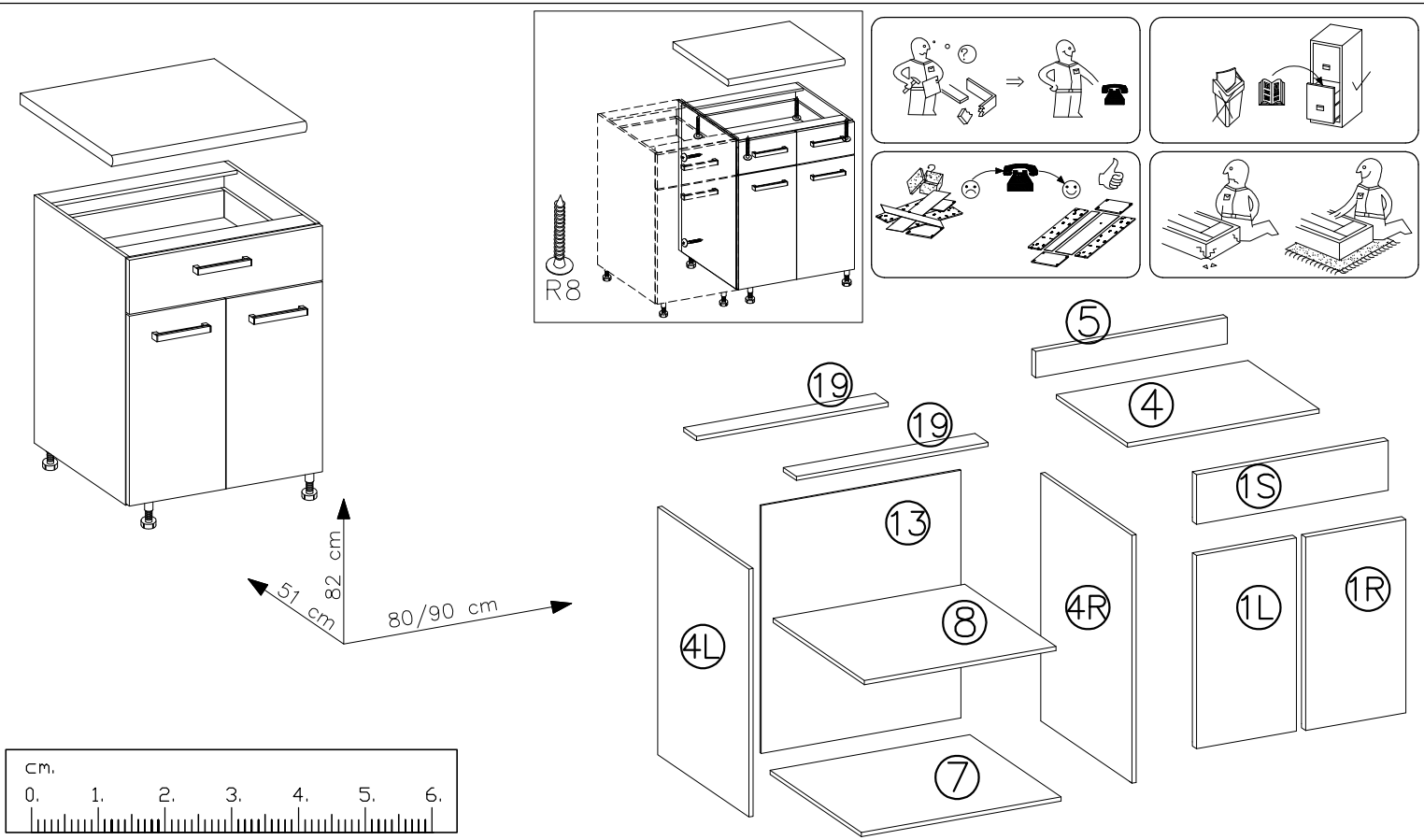
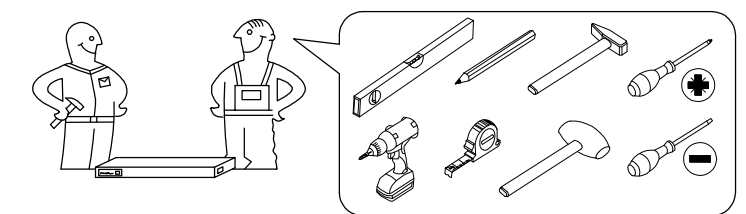

Package No 1

4L 720x490	4R 720x490
7 6D-768x470 7D-868x470	8 6D-768x460 7D-868x460
13 6D-718x783 7D-718x883	19 6D-768x80 7D-868x80

Package No 2

1S 6D-795x140 7D-895x140	1R 6D-395x572 7D-445x572
	1L 6D-395x572 7D-445x572
S1 3	M4.0x27mm R2 6

Package No 4

4 6D-694x430 7D-794x430	5 6D-682x67 7D-782x67
----------------------------	--------------------------





Package No 3

$\varnothing 8 \times 30 \text{mm}$ A 8	$\varnothing 3.5 \times 30 \text{mm}$ B 10	E4 4	F10 14	F5 4+2	$\varnothing 3.5 \times 30 \text{mm}$ R8 6
$\varnothing 35 / \text{KR}-0$ G6 4	$\varnothing 5.0 \times 13 \text{mm}$ P9 8	J4 4	L 4	O 1	$\varnothing 3.5 \times 16 \text{mm}$ P4 20

BASIC

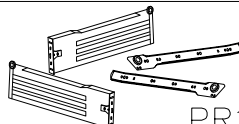

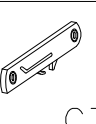
PR1 1SET	C3 2
$\varnothing 5.0 \times 13 \text{mm}$ P9 4	$\varnothing 3.5 \times 16 \text{mm}$ P4 20
$\varnothing 5.0 \times 13 \text{mm}$ PR2 1SET	P9 8
$\varnothing 3.5 \times 16 \text{mm}$ P4 12	

1

	 $\varnothing 5.0 \times 13 \text{mm}$	 4.0 x 20mm		
1SET	4	4	2	4

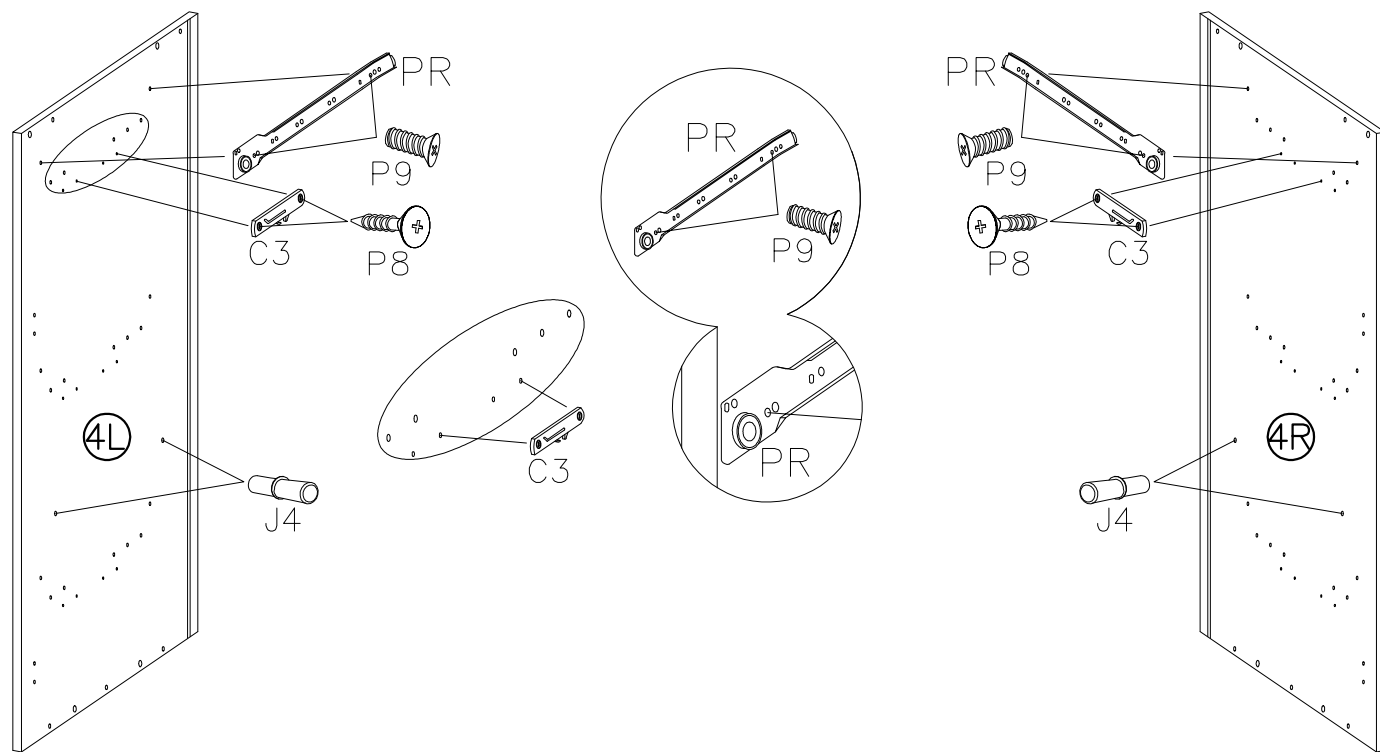
BASIC

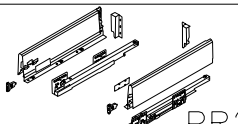



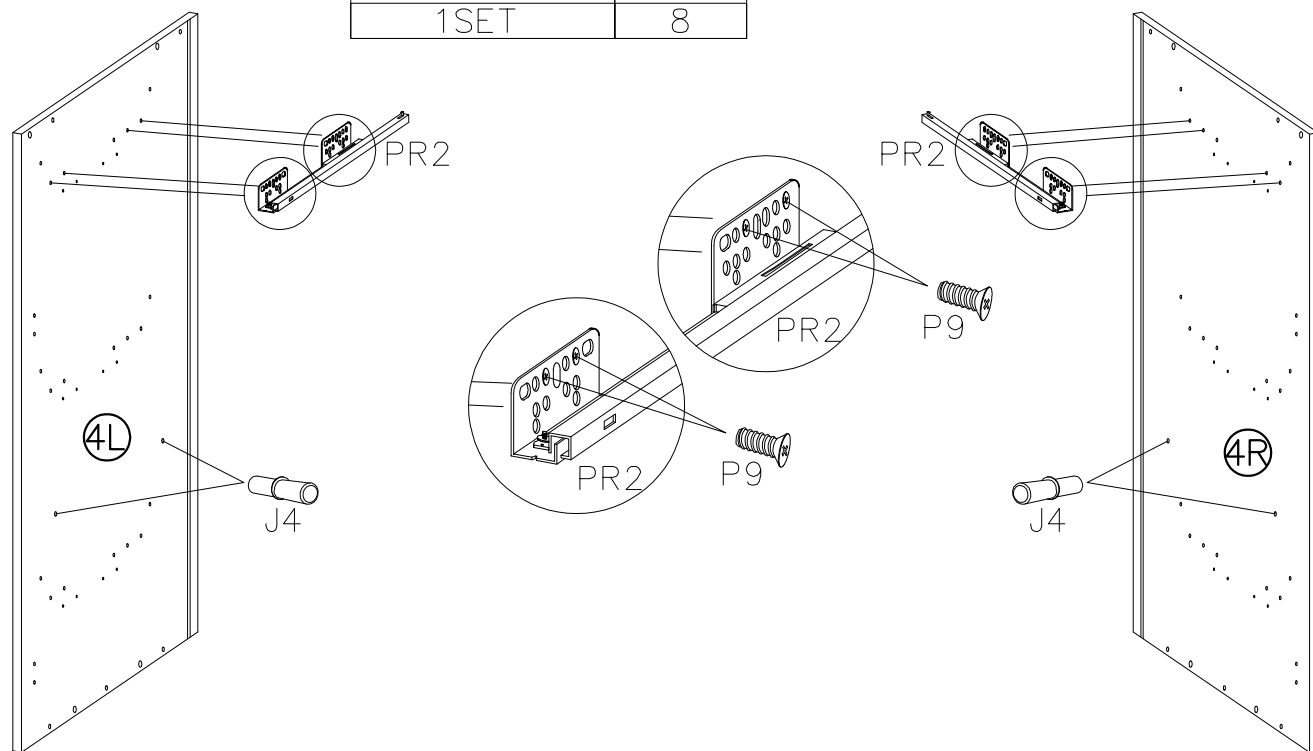

	 $\varnothing 5.0 \times 13 \text{mm}$
1SET	8

LUX

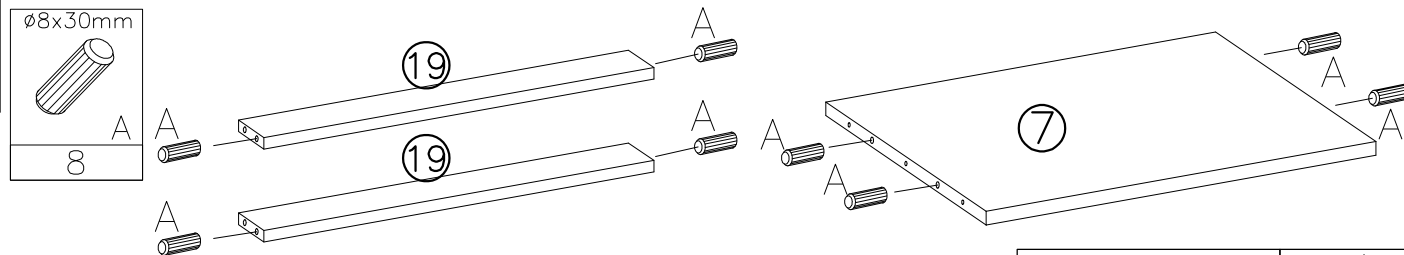

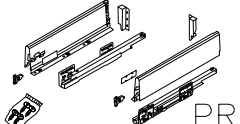
2





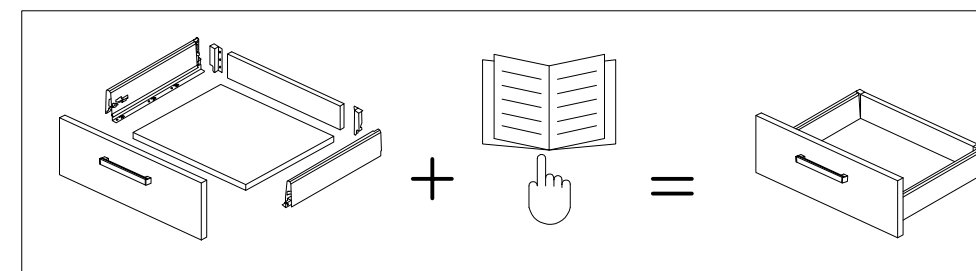
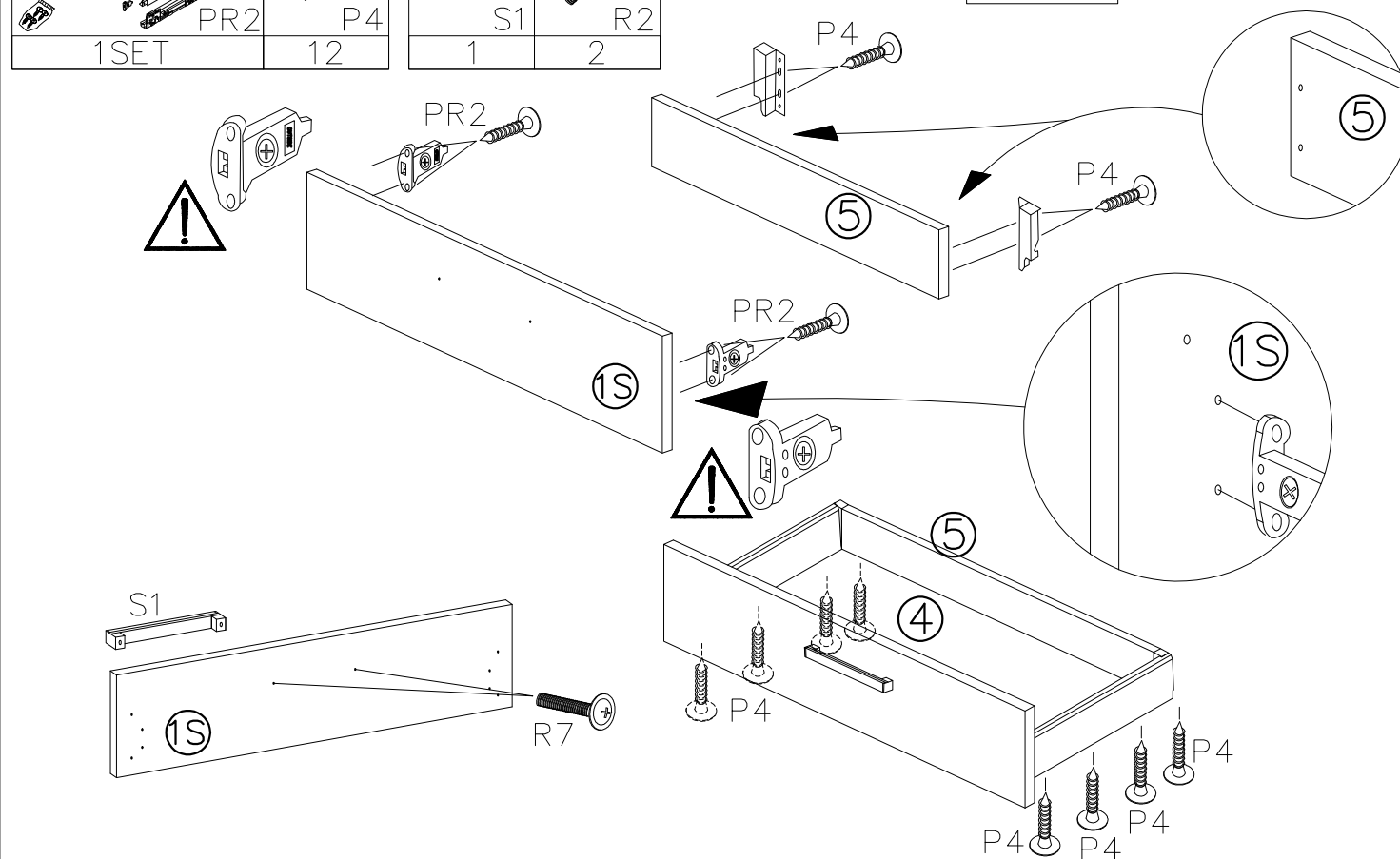

	 $\varnothing 3.5 \times 16 \text{mm}$		 M4.0 x 27mm
1SET	12	1	2

LUX

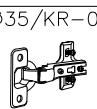

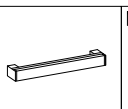
6

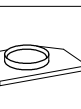
 $\varnothing 35 / \text{KR}-0$	 $\varnothing 5.0 \times 13 \text{mm}$		 M4.0 x 27mm	
4	8	2	4	4

