

40 DK-2100

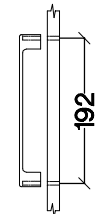

- KUH.30009
- KUH.40025
- KUH.40026

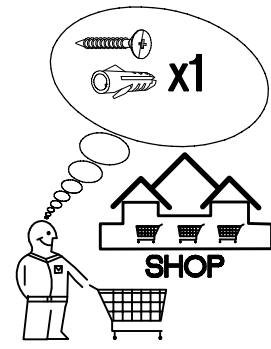

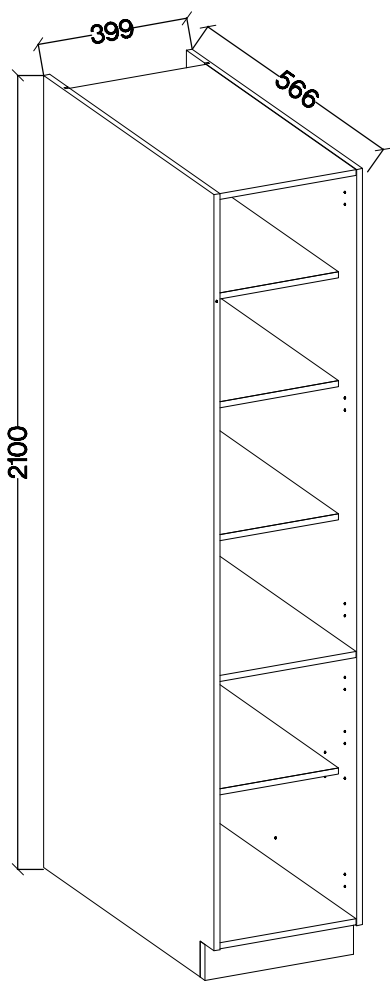
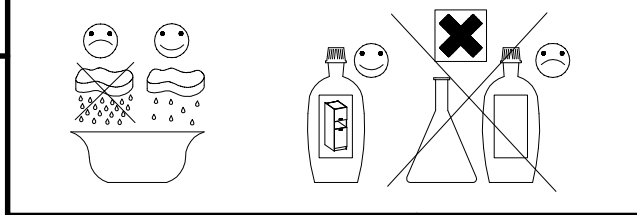
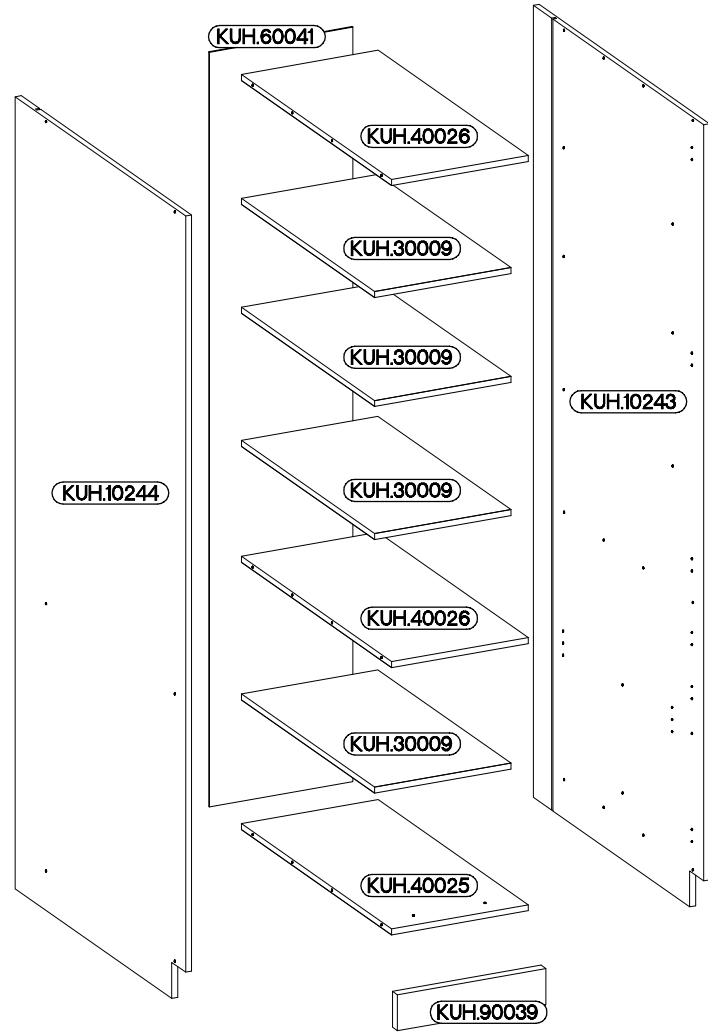
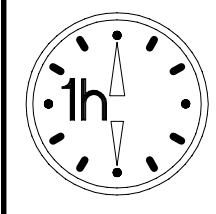

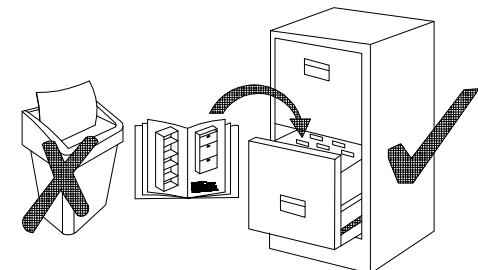
 A 12	 B 12	 E1 12	 E9 2	 F2 4	 HG 5	 J 16	 K28 2	 K29 1	 L25 1
 O 1	 P4 2	 P5 16	 P7 10-15	 R2 4	 S15 2				





ISM-KUH-00991

1

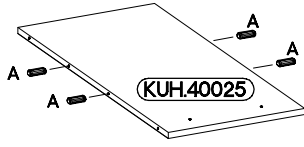
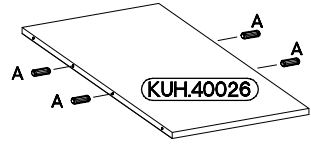
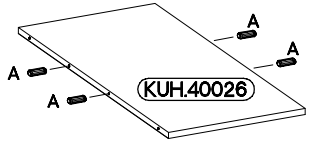
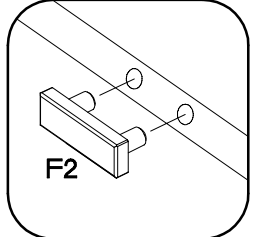
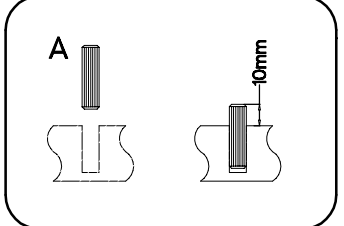
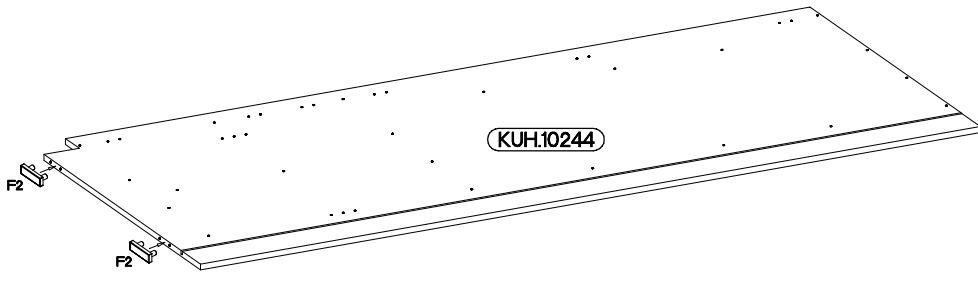
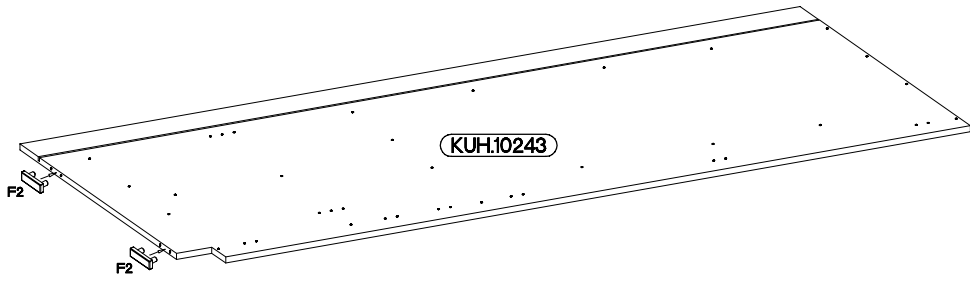
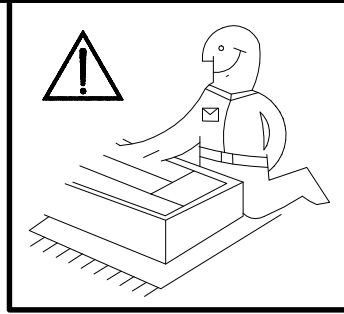
6.5x48x16	+8x30mm
	
F2	A
4	12

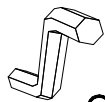

2

6,4 x 50mm		
B	O	E1
6	1	6

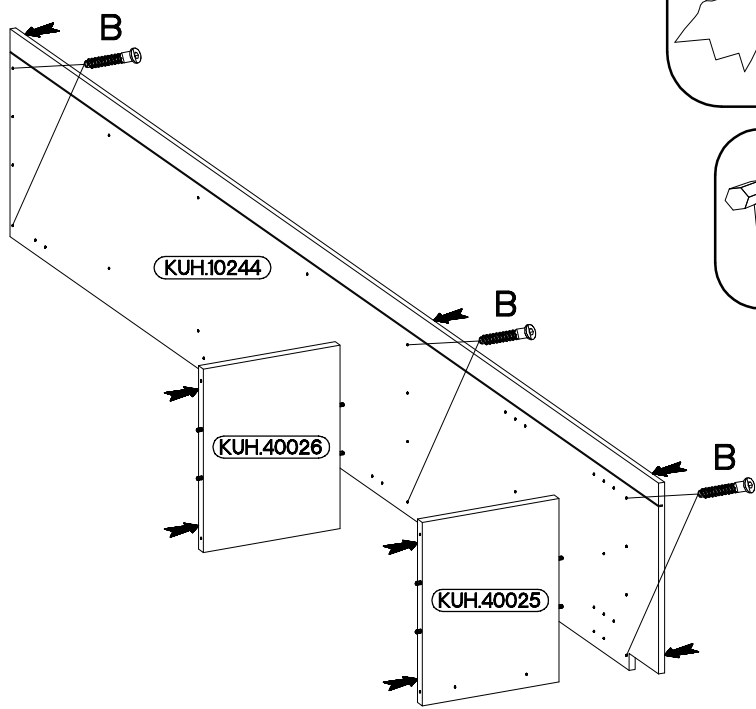
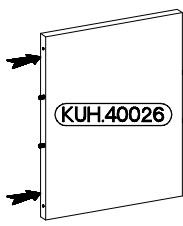
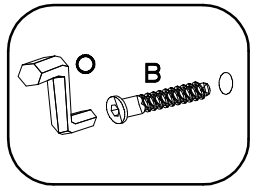
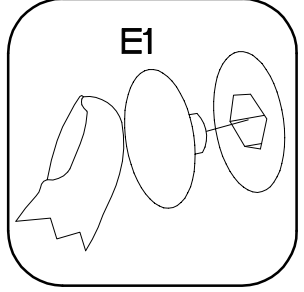

3

6,4 x 50mm

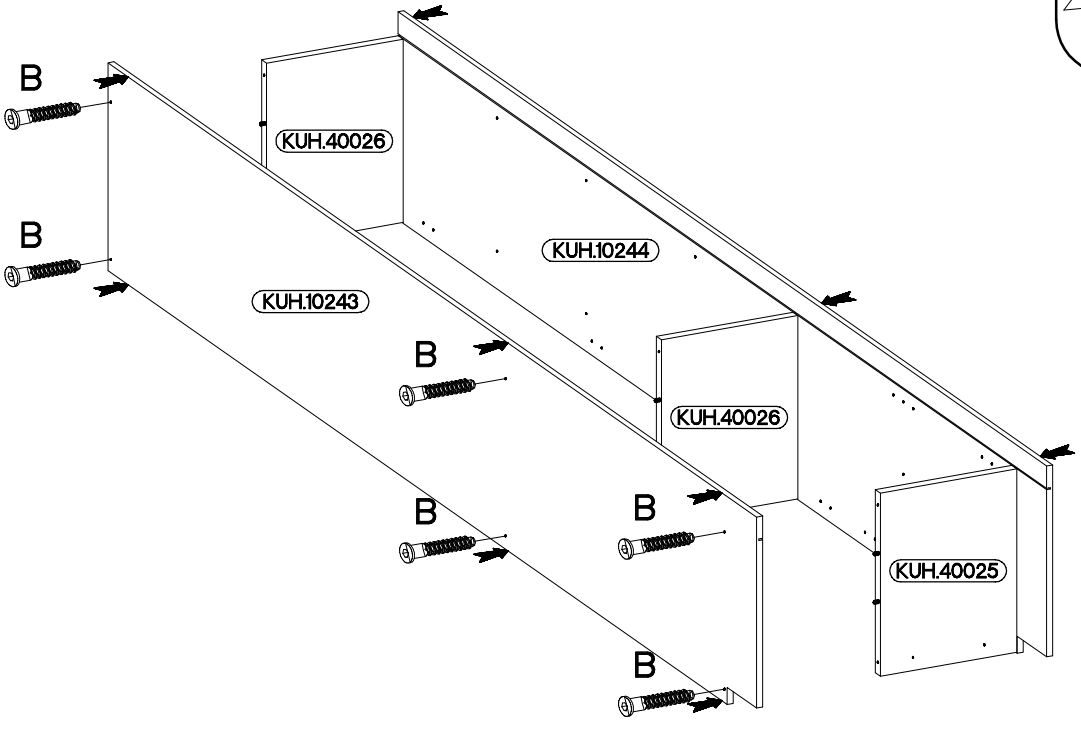
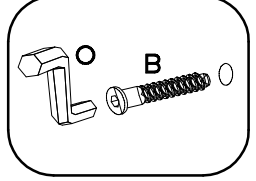
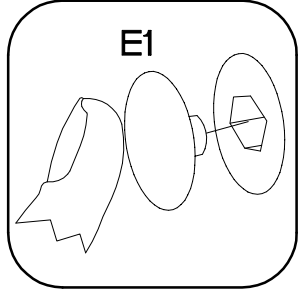
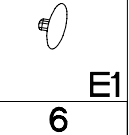
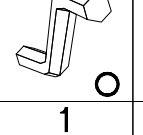
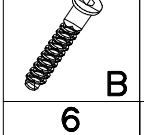

4

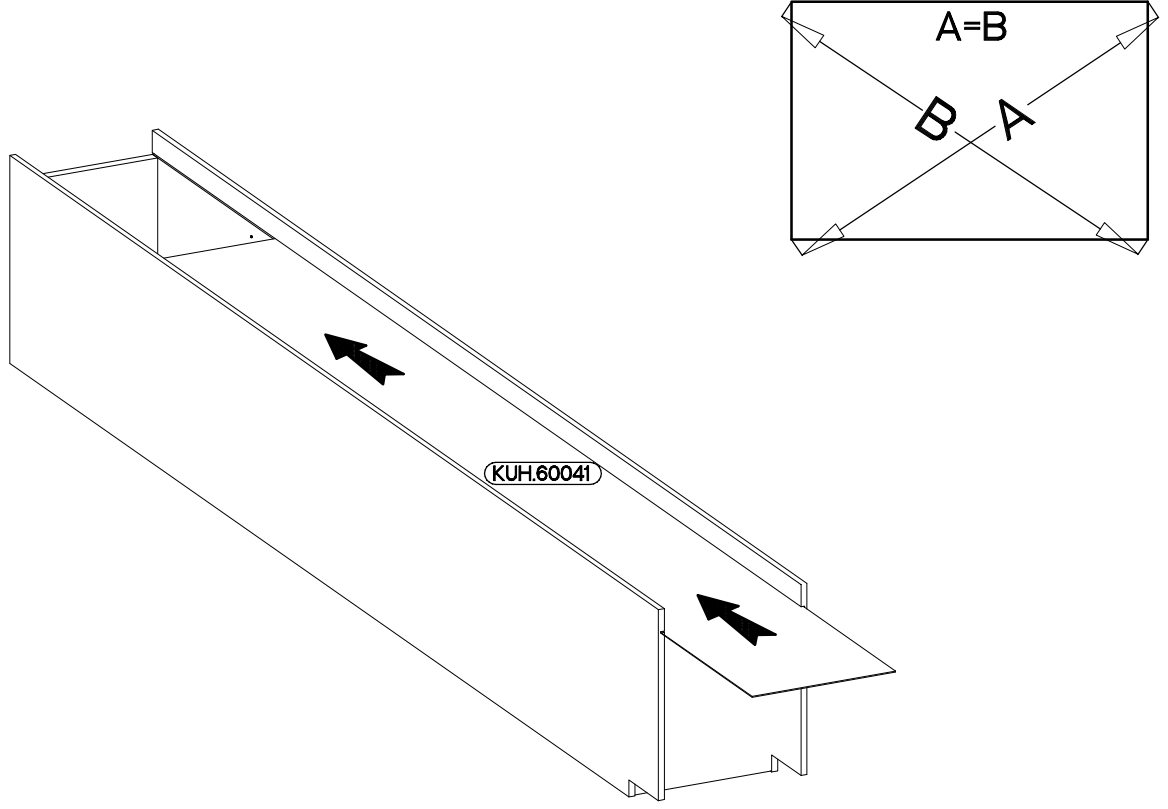

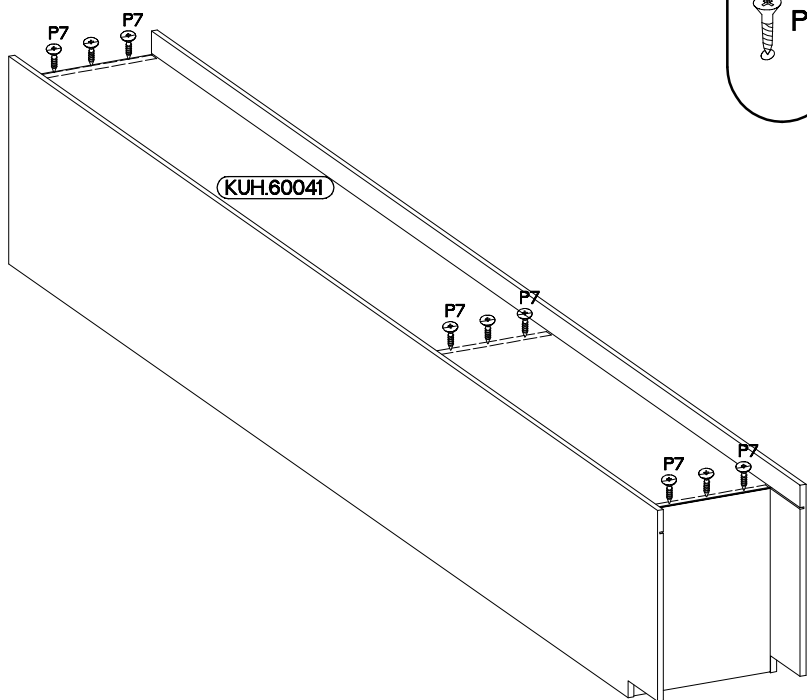
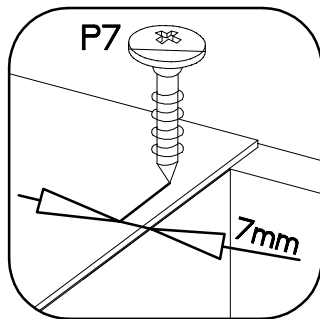
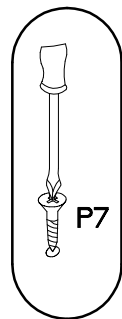

5

±3.0x20mm

P7
10-15

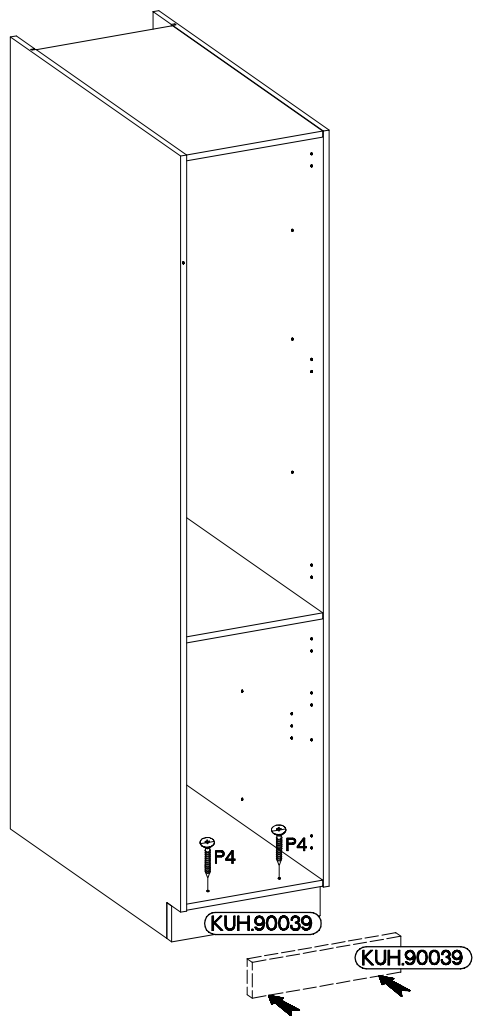
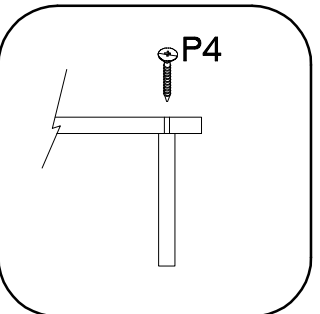
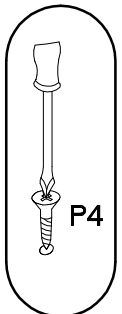

6

±4.0x45mm	
	E9
2	2



7

+5/19mm



J

16

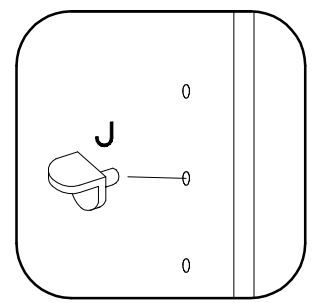
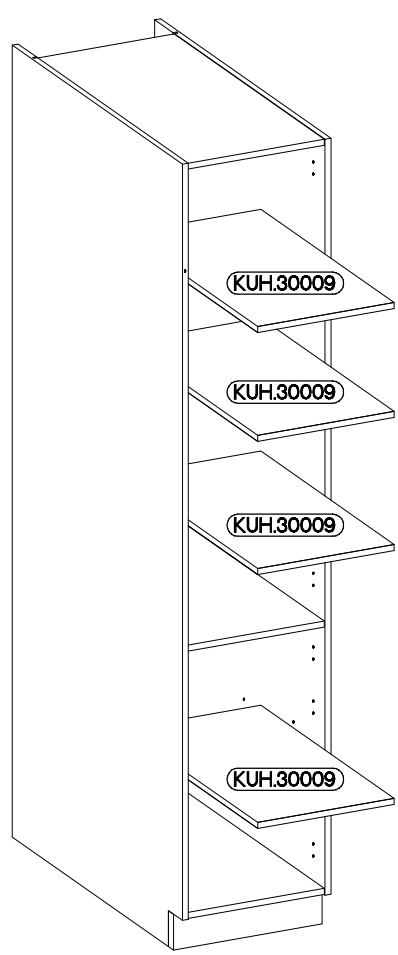

8

+3.5x13mm

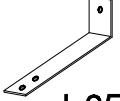

L25

1



P5

2

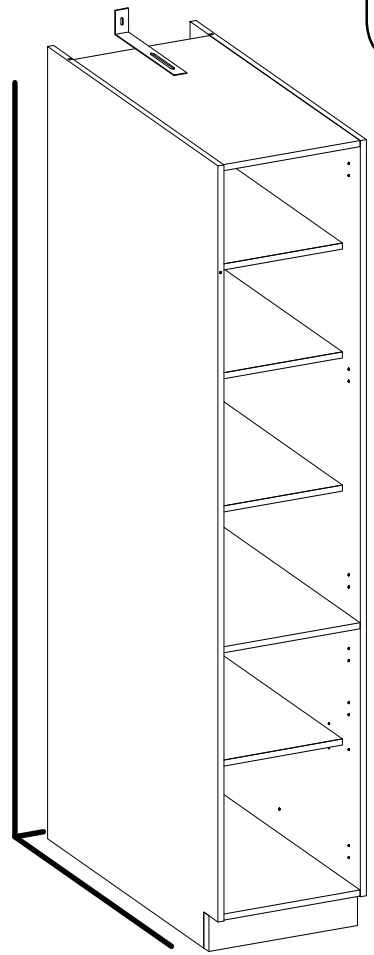

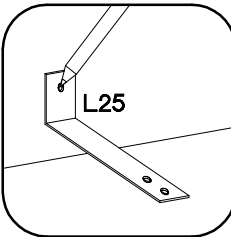
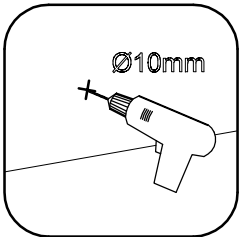
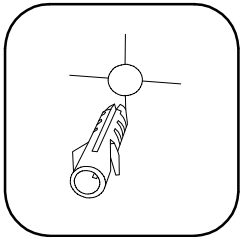
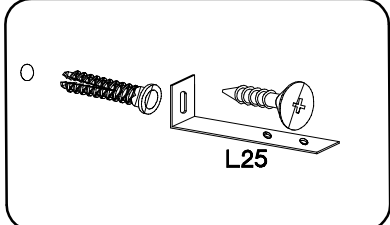
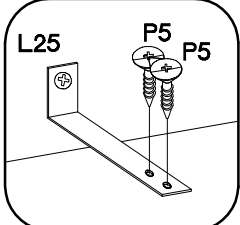
1. 
2. 
3. 
4. 
5. 

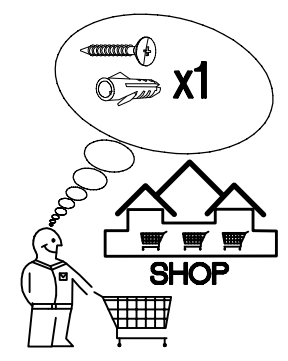
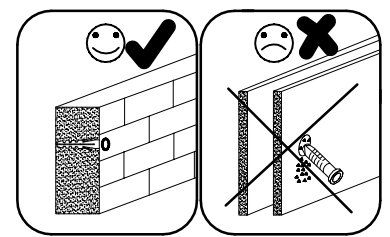

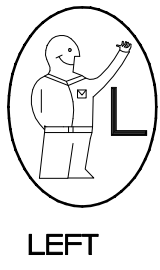
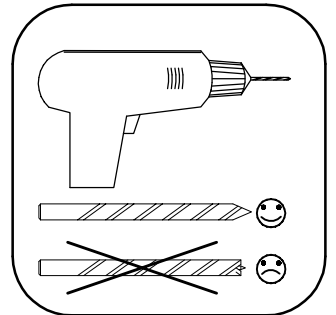
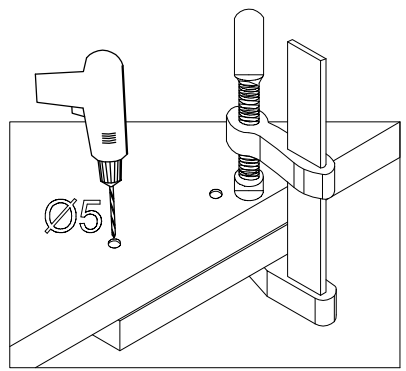
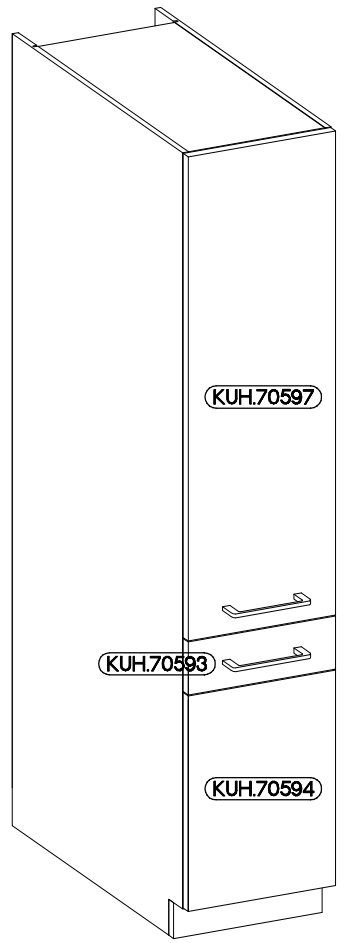

LEFT

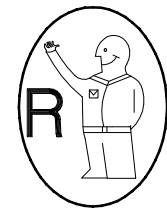
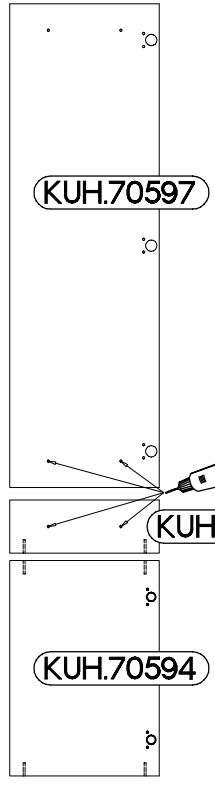
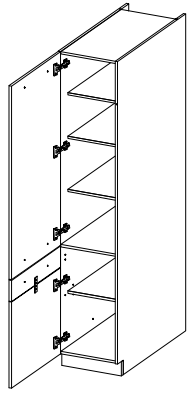

RIGHT

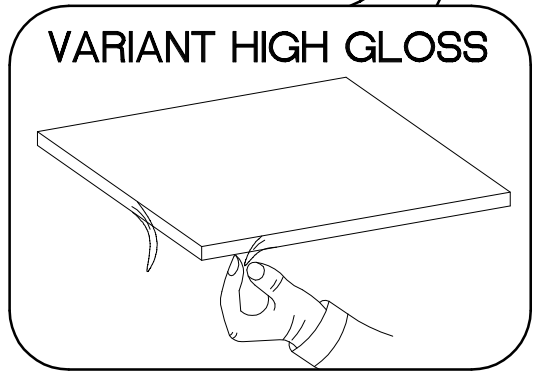
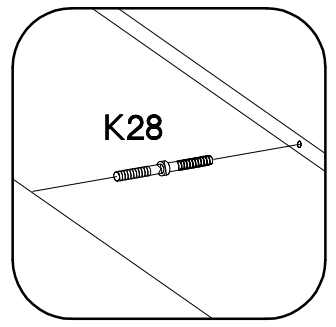
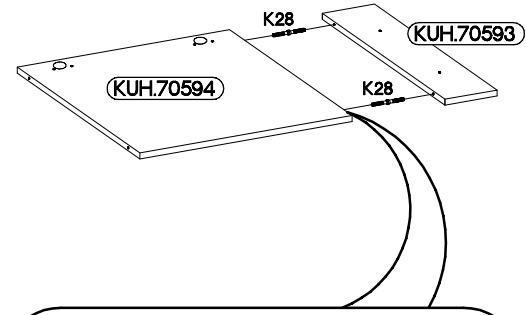
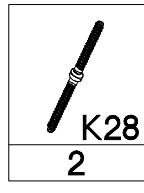
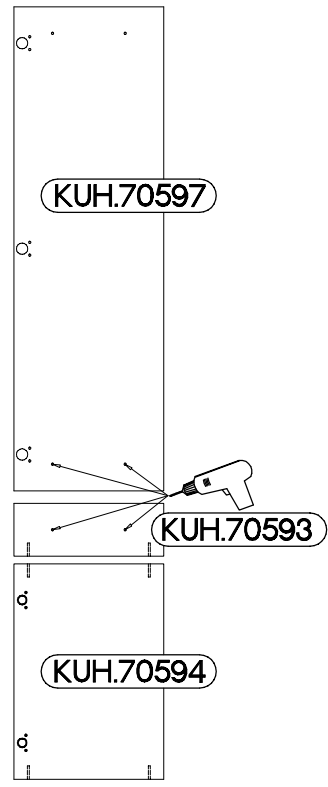
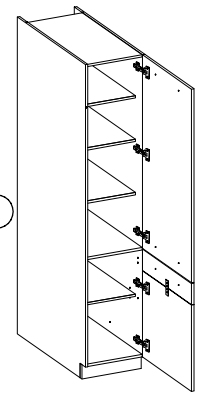

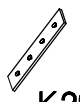

11

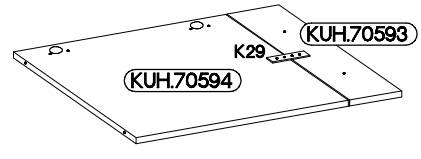
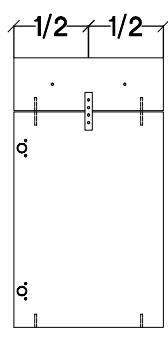
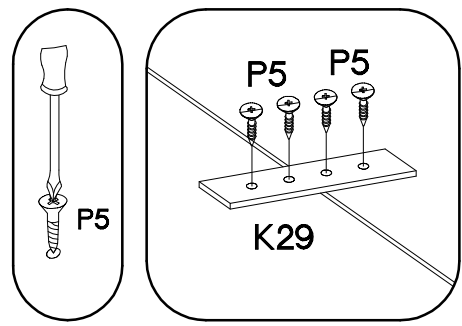
	±3.5x13mm
K29	P5
1	4

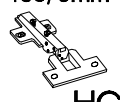

12

±35/0mm	±3.5x13mm
	
HG	P5
5	10

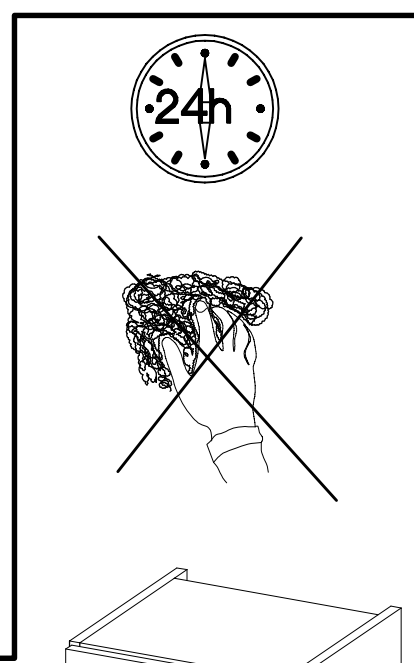
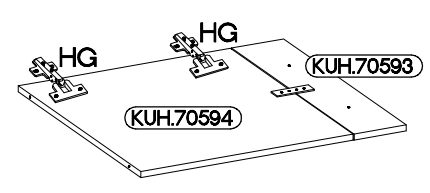
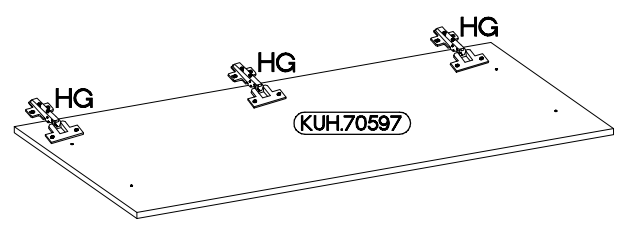
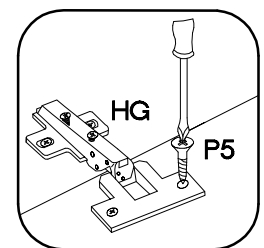
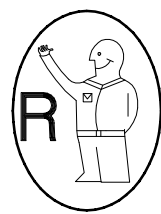

VARIANT HIGH GLOSS

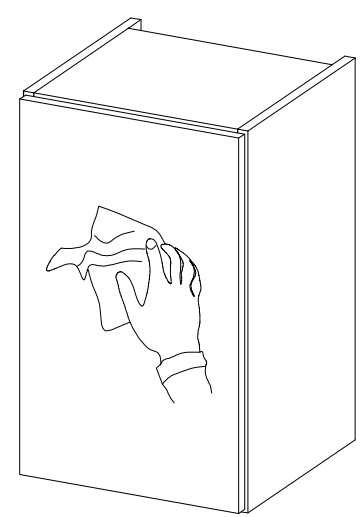
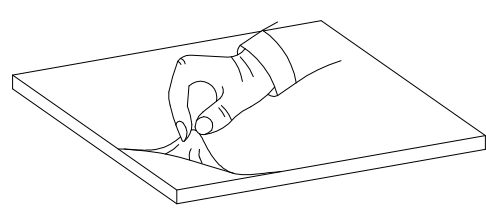
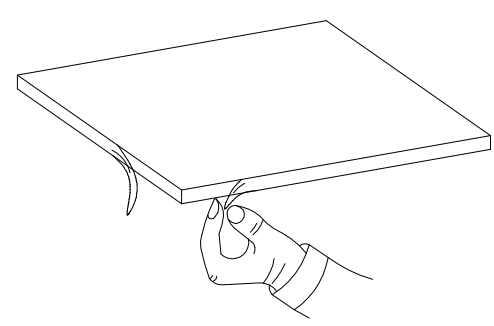

+4.0x30mm

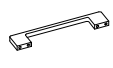
 R2 4	 S15 2
---	--

