

Ø10mm  
40 G-90 1F

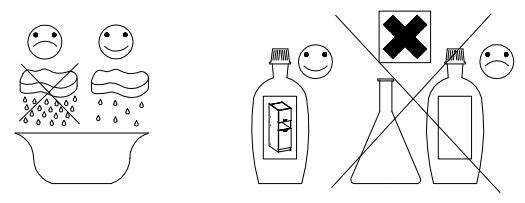

max.  
5kg

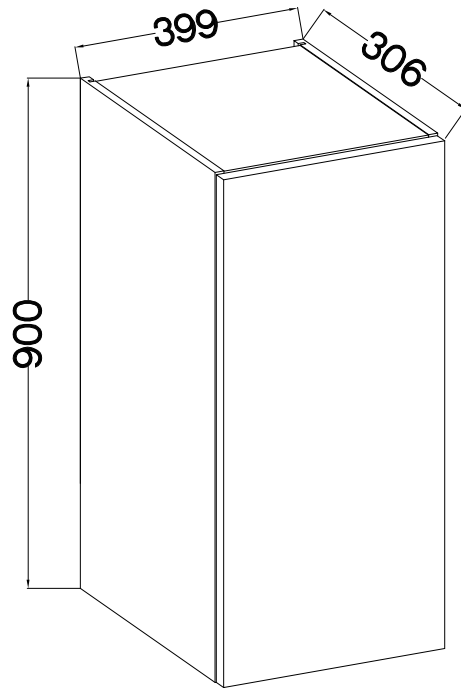

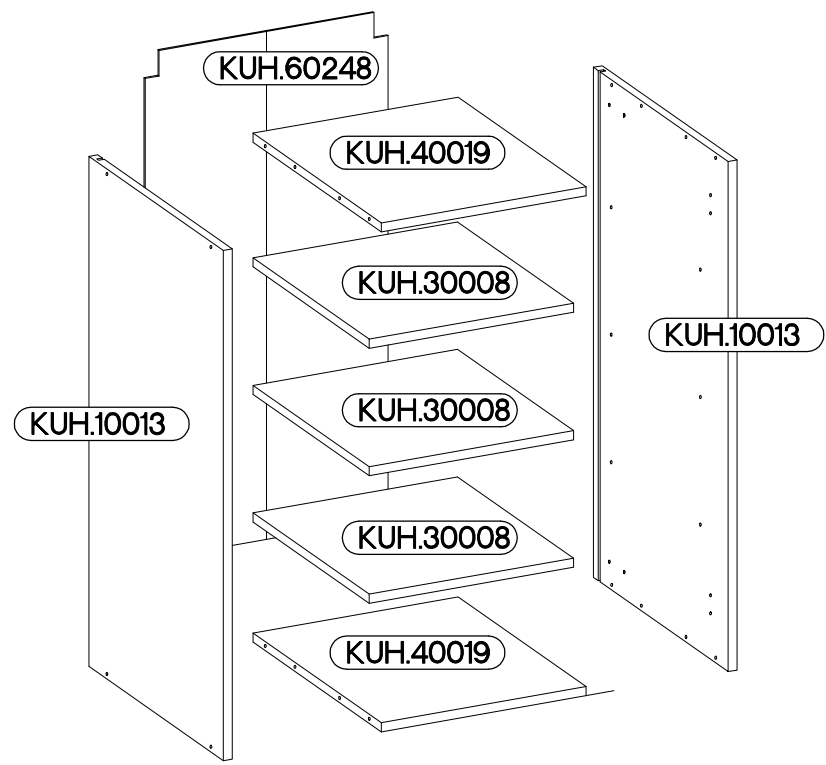
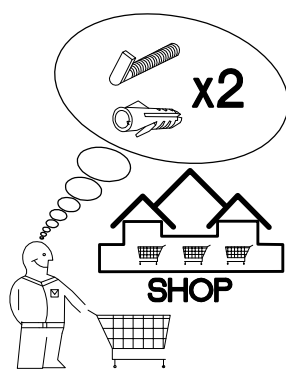
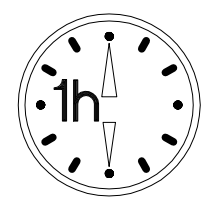

Ersatzteil Nummer	Dimension
KUH.10013 x2	900x290x16
KUH.30008 x3	366x250x16
KUH.40019 x2	367x276x16
KUH.60248	896x385x2,5

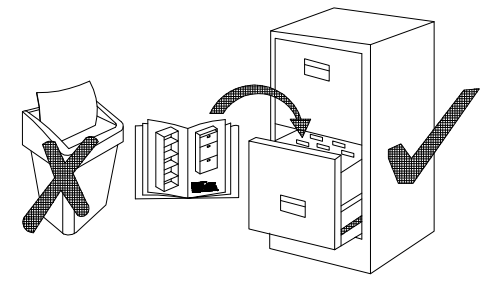
 <b>A</b> 8	 <b>B</b> 8	 <b>E1</b> 8	 <b>HG</b> 2		
 <b>J</b> 12	 <b>K</b> 2	 <b>O</b> 1	 <b>P5</b> 4	 <b>P7</b> 8-10	 <b>P8</b> 4



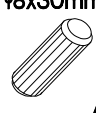

ISM-KUH-01135

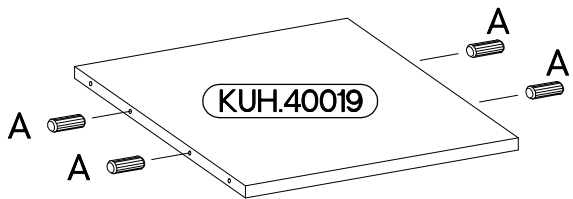
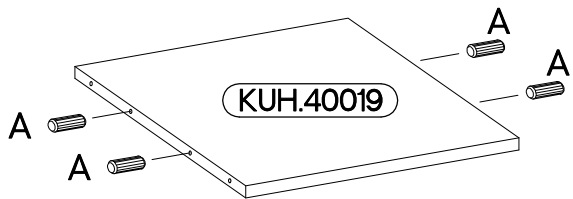
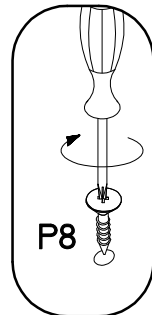
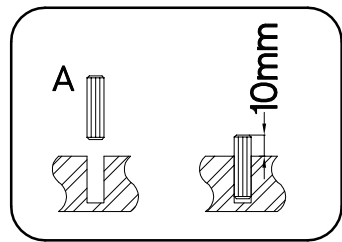
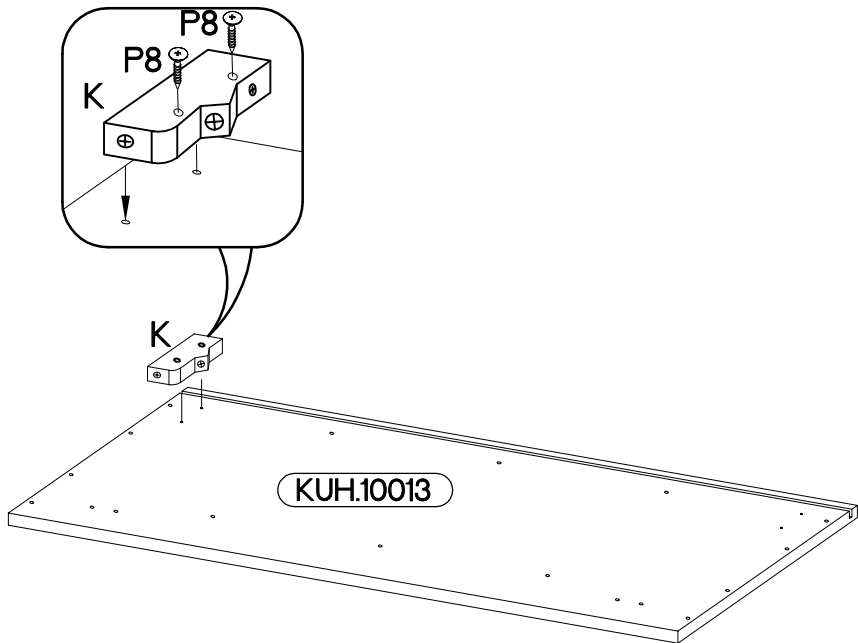
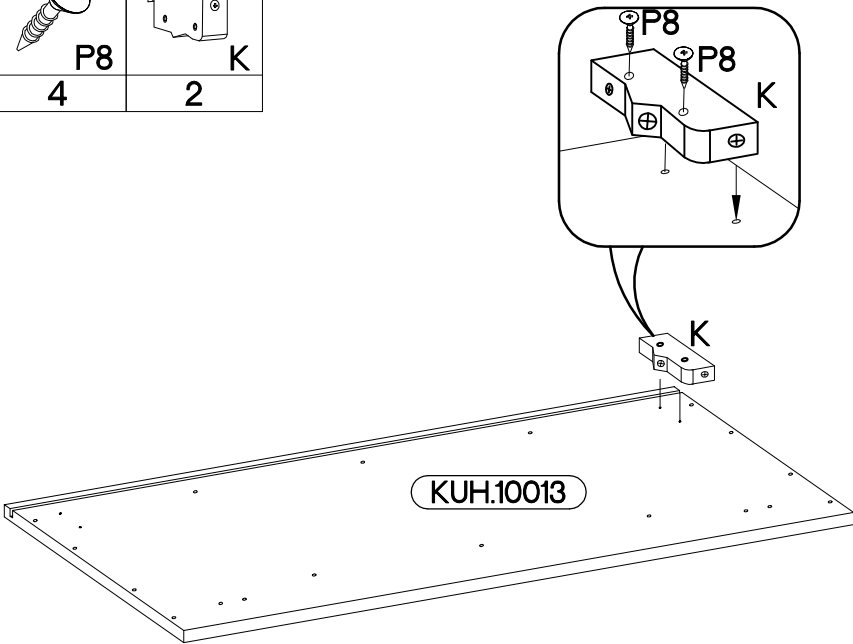
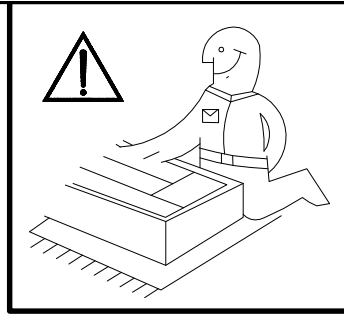
 ‡8x30mm A	 ‡4.0x30mm P8	 K
8	4	2



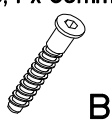
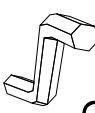

2

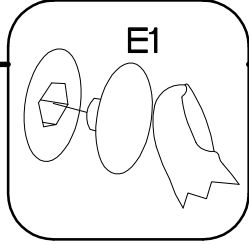
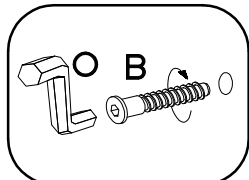
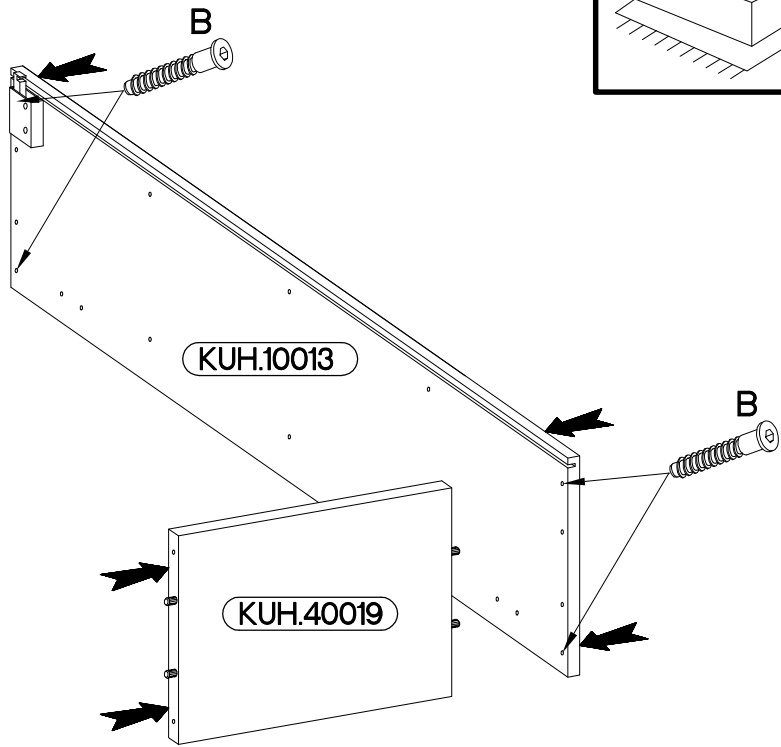
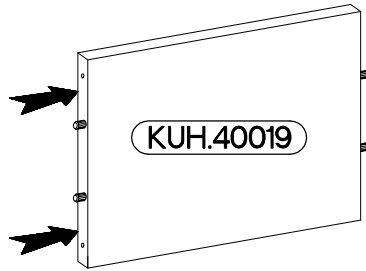
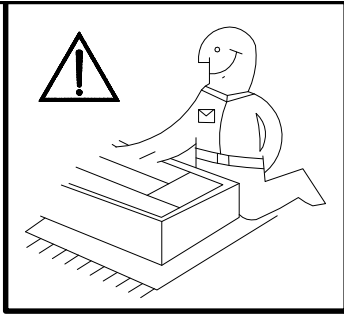
6,4 x 50mm		
		
<b>B</b>	<b>O</b>	<b>E1</b>
4	1	4

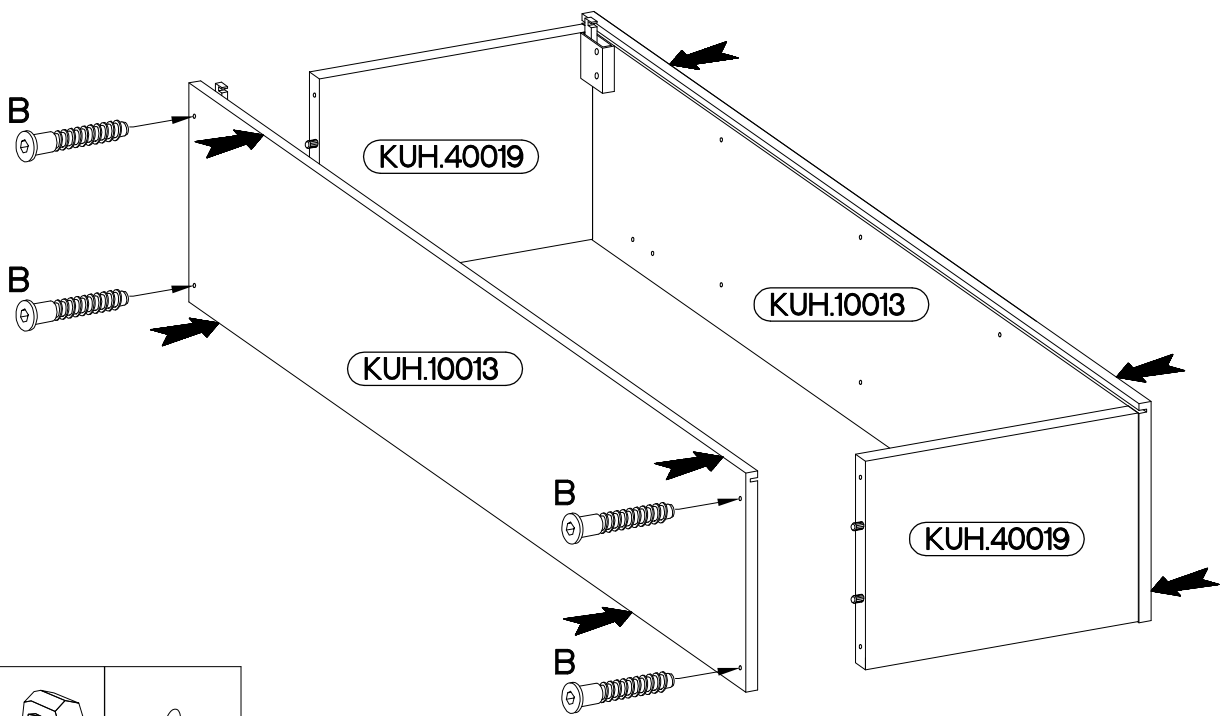

3

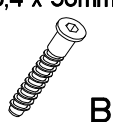
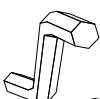

6,4 x 50mm		
		
<b>B</b>	<b>O</b>	<b>E1</b>
4	1	4

4

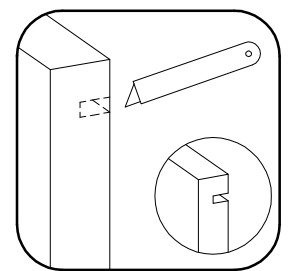
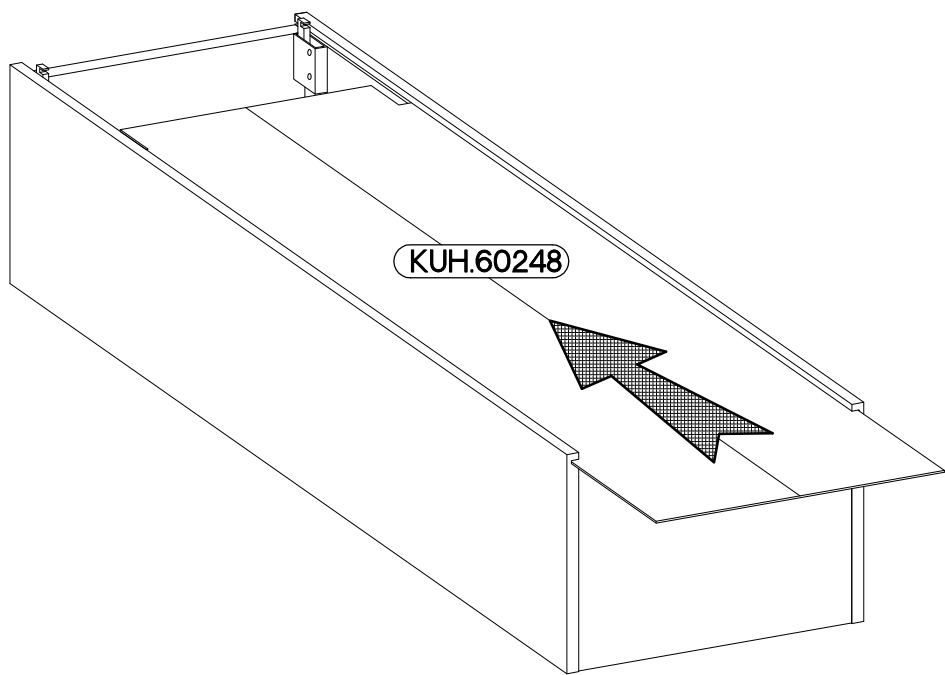
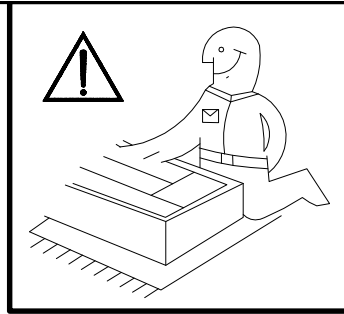

5

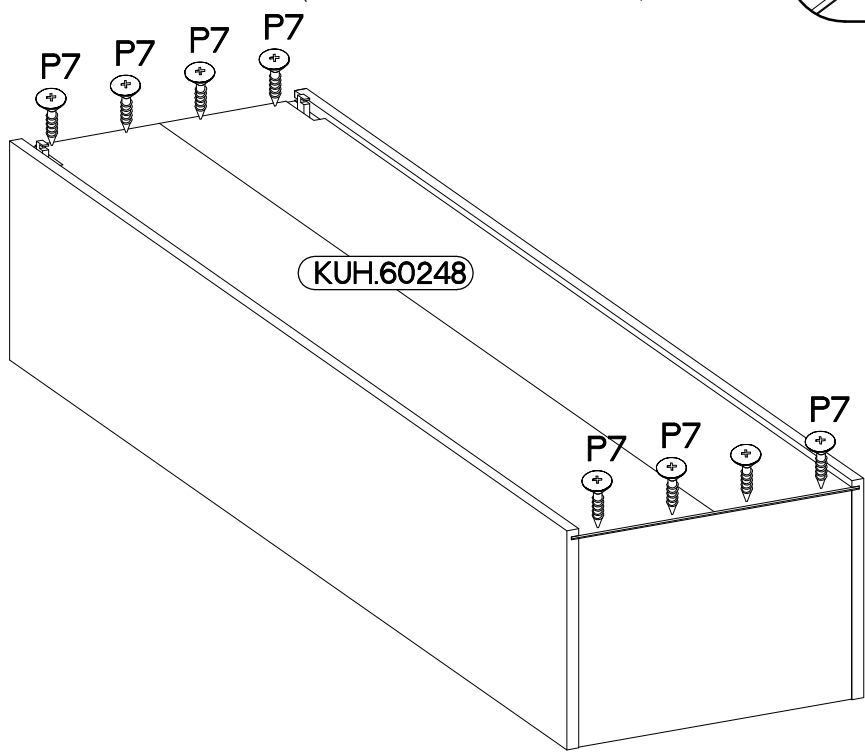
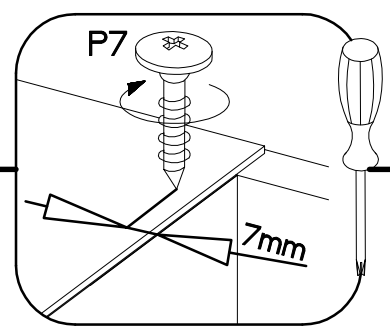
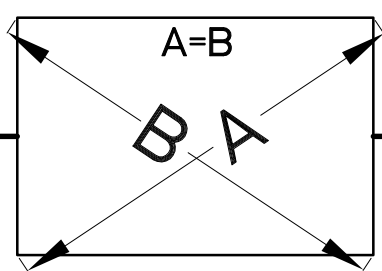
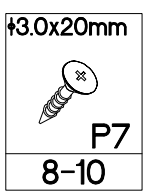

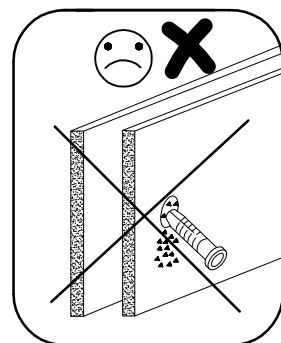
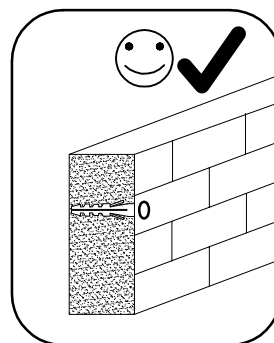
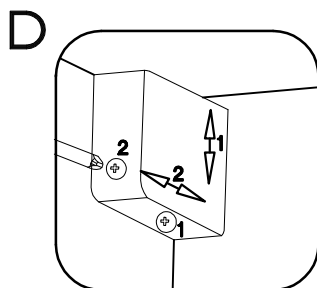
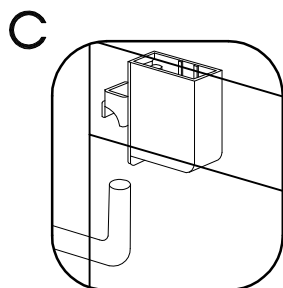
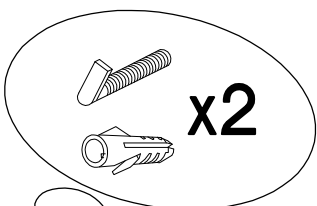
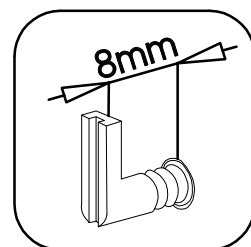
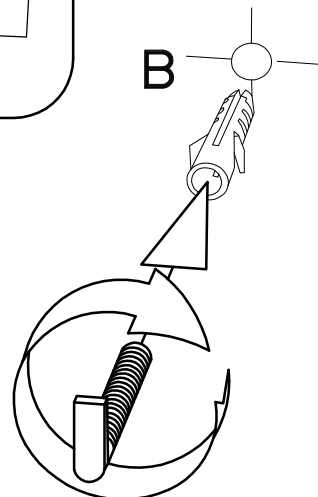
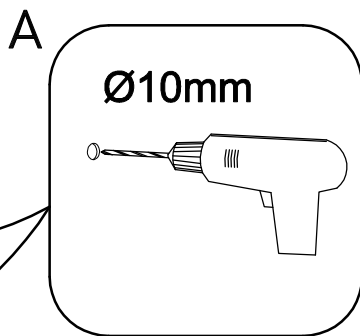
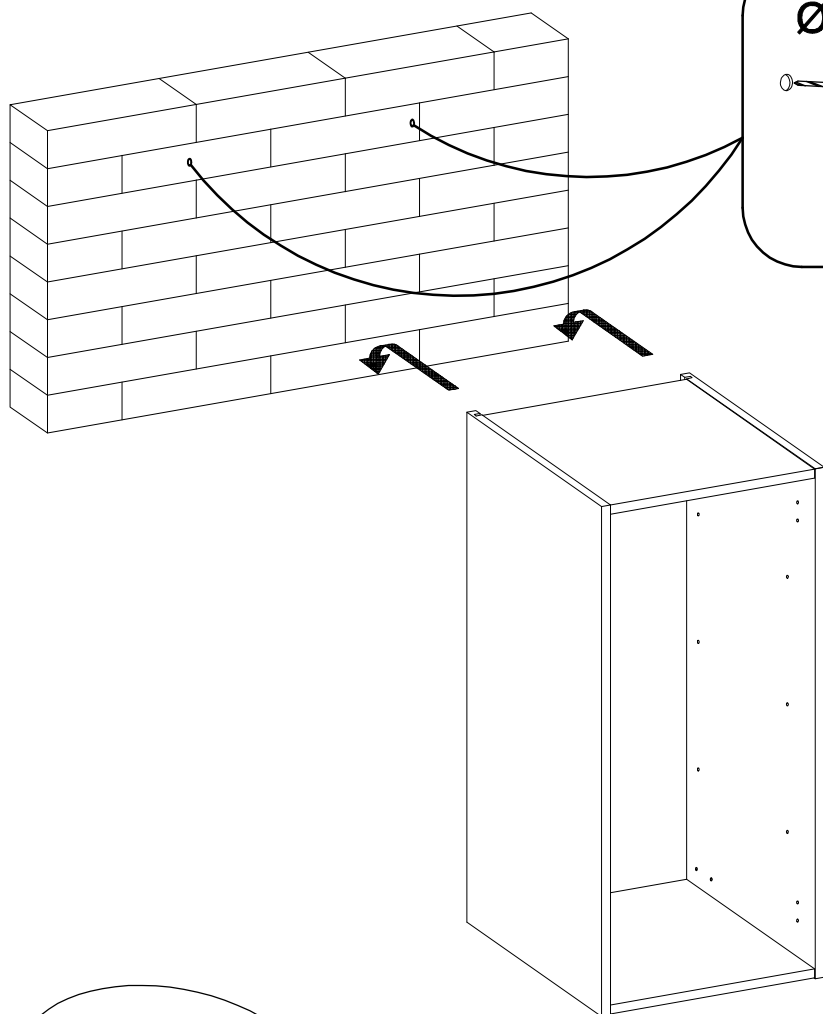
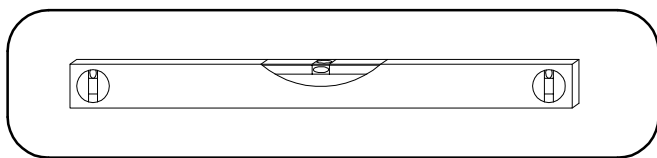

7

±5/19mm  
J  
12

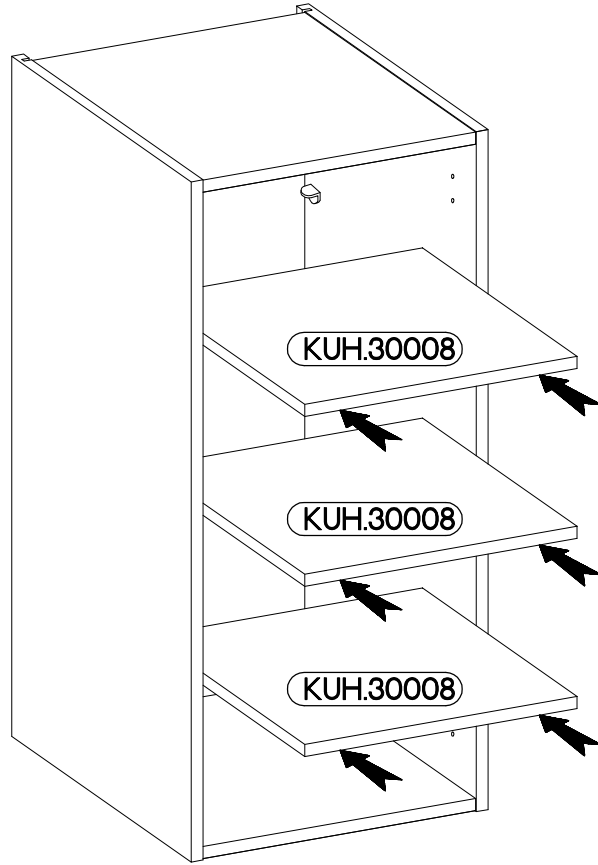
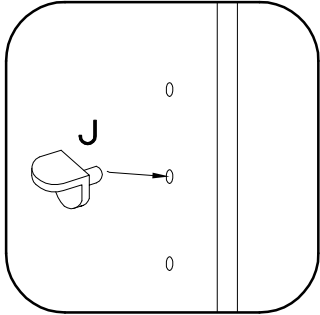

8

FRONT

