

TYP 460

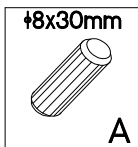

A

12

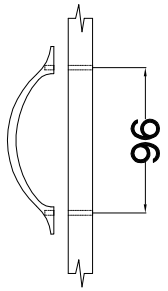
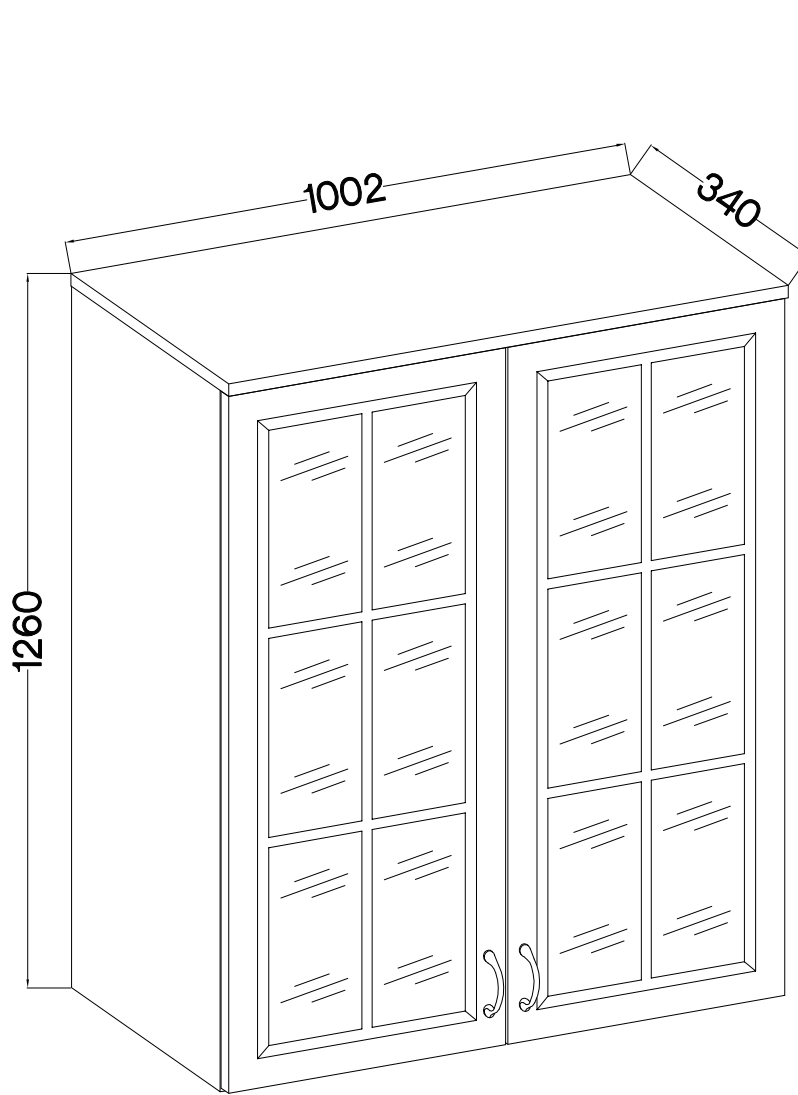
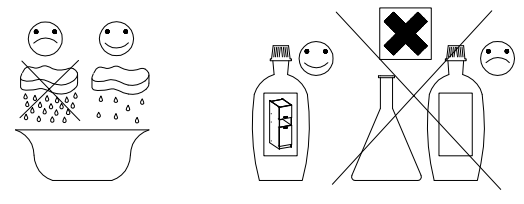
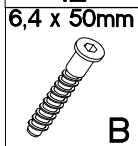

B

2



C

10



D2

10



E

10



HG

6



J3

16

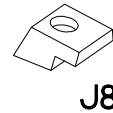

J8

24

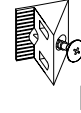

L

10

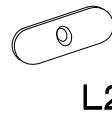

L2

7

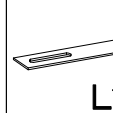

L19

1

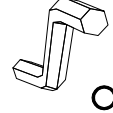

O

1

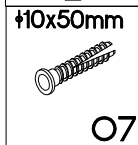

O7

1



P5

14



P7

15

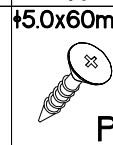

P12

1

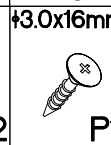

P11

24



S

2



M4x22mm

U

4

ISM-FLA-08

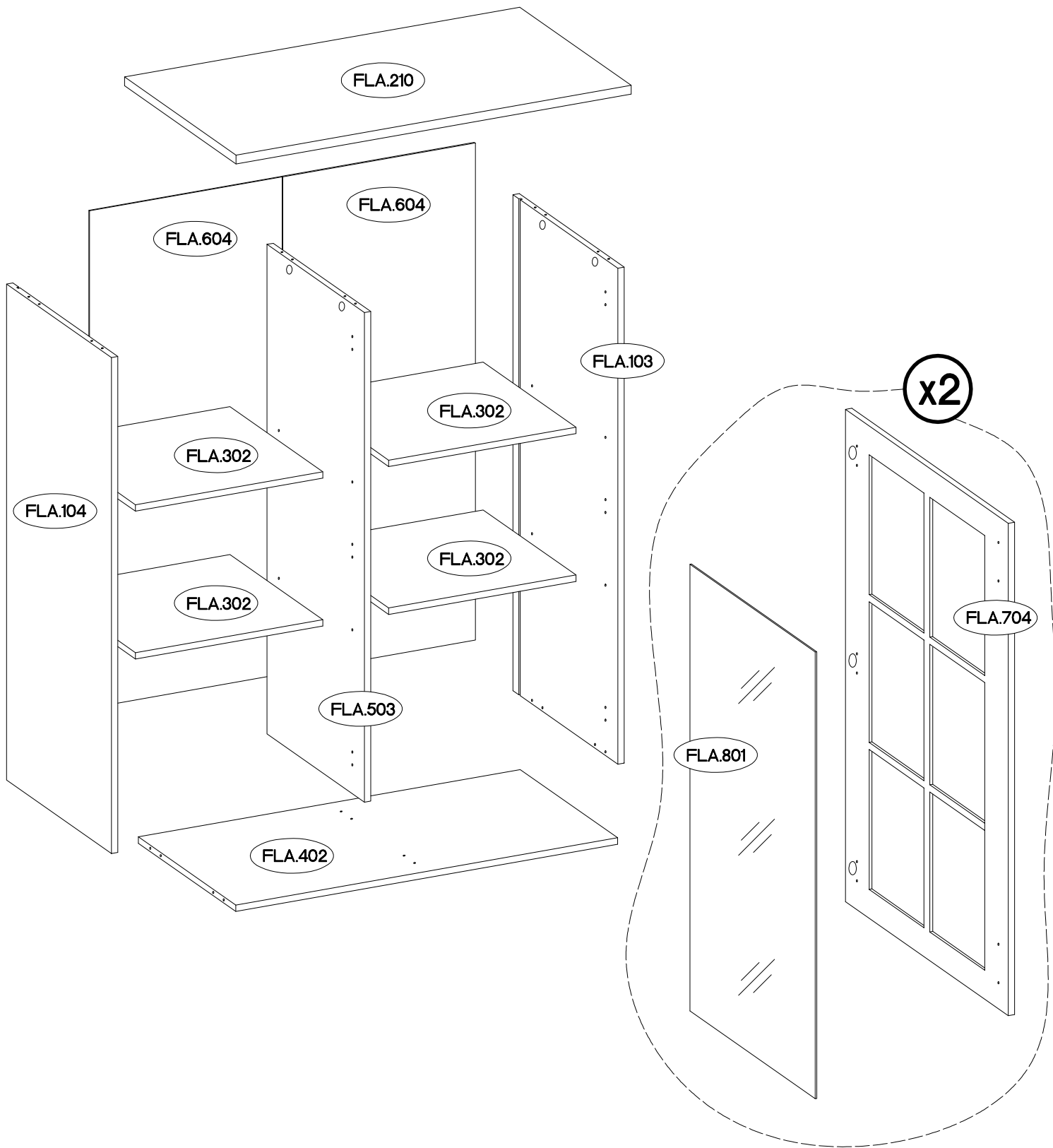



FLA.302

FLA.402

Colli	Ersatzteil Nummer	Dimension
Colli 1/2	FLA.103	1238x320x16
	FLA.104	1238x320x16
	FLA.210	1002x340x22
	FLA.302 x4	475x283x16
	FLA.402	968x297x16
	FLA.503	1222x297x16

Colli	Ersatzteil Nummer	Dimension
Colli 2/2	FLA.604 x2	1241x488x2.5
	FLA.704 x2	1229x496x16
	FLA.801 x2	1115x382x4

1

$\varnothing 8 \times 30 \text{mm}$  A 12	$\varnothing 15/12 \text{mm}$  C 10	$L=20 \text{mm}$  D2 4
---	---	--

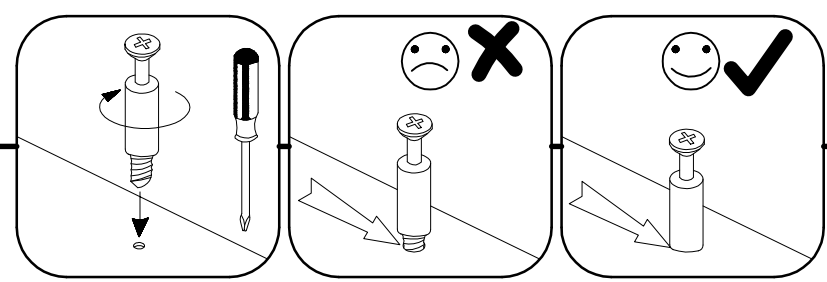
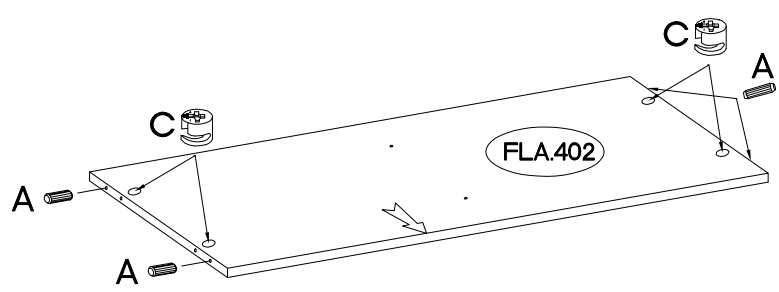
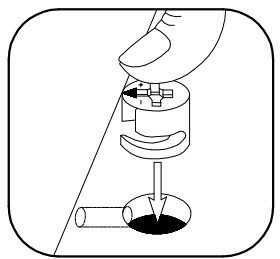
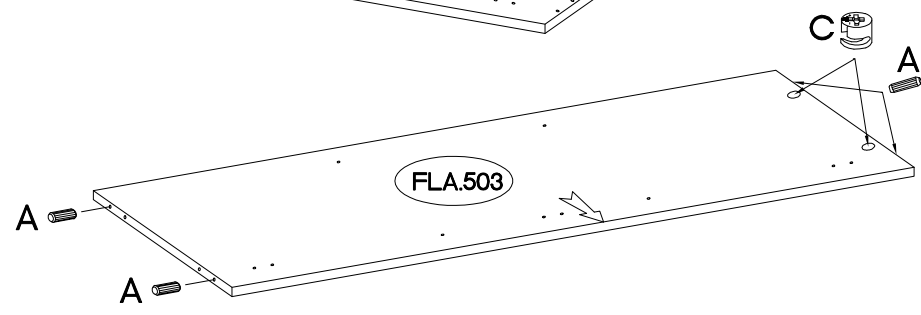
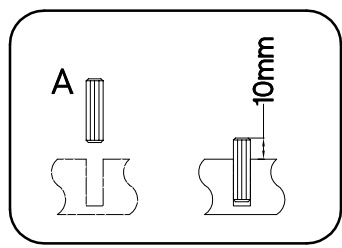
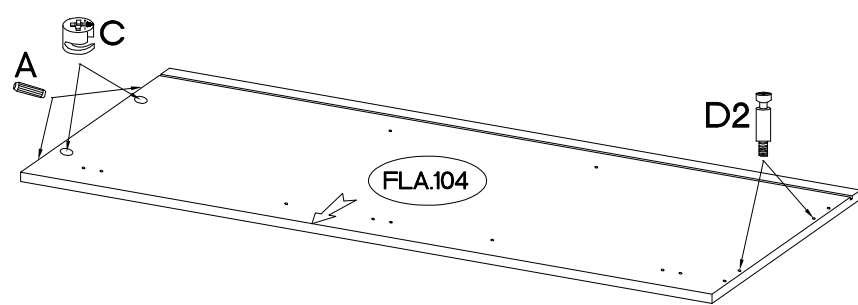
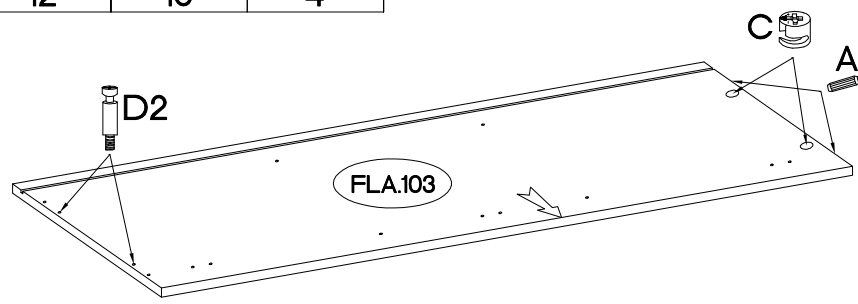
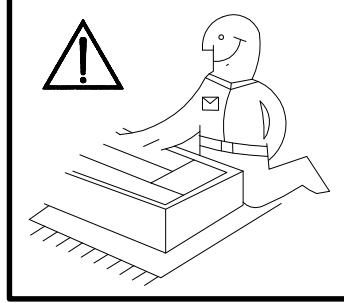

2

$L=20 \text{mm}$  D2 6

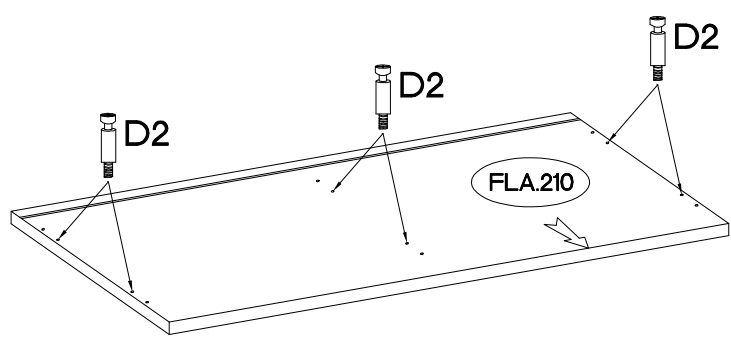

3

6,4 x 50mm

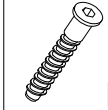

B

2



O

1

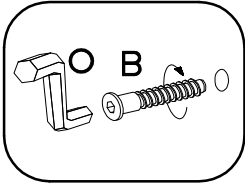
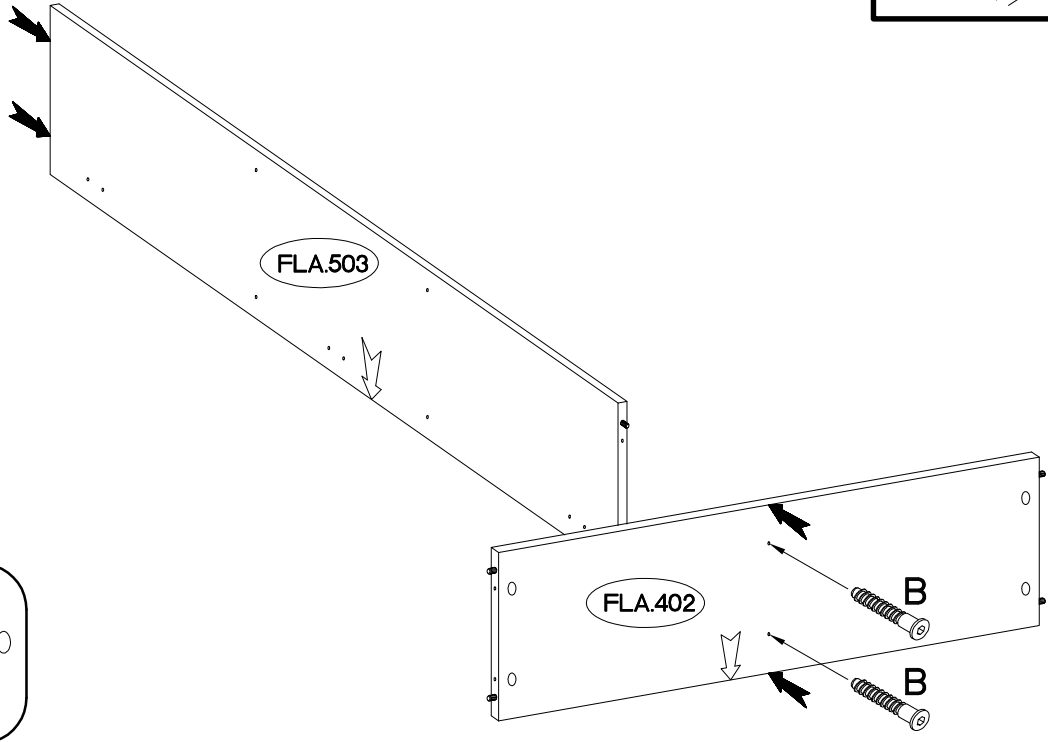
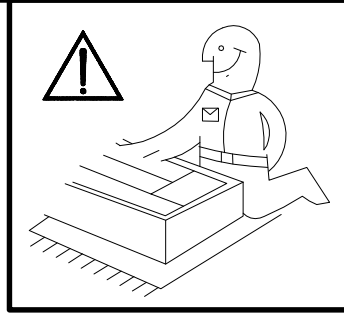
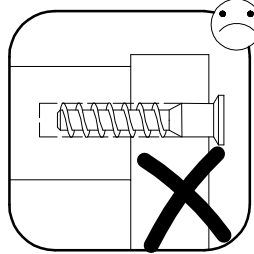
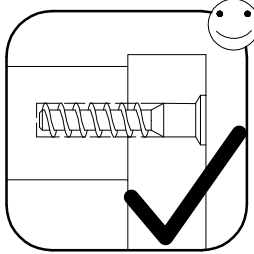

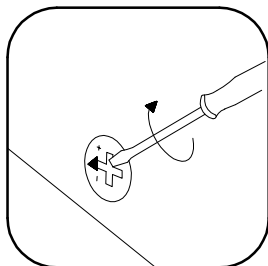
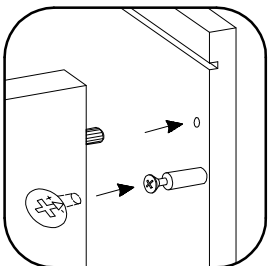
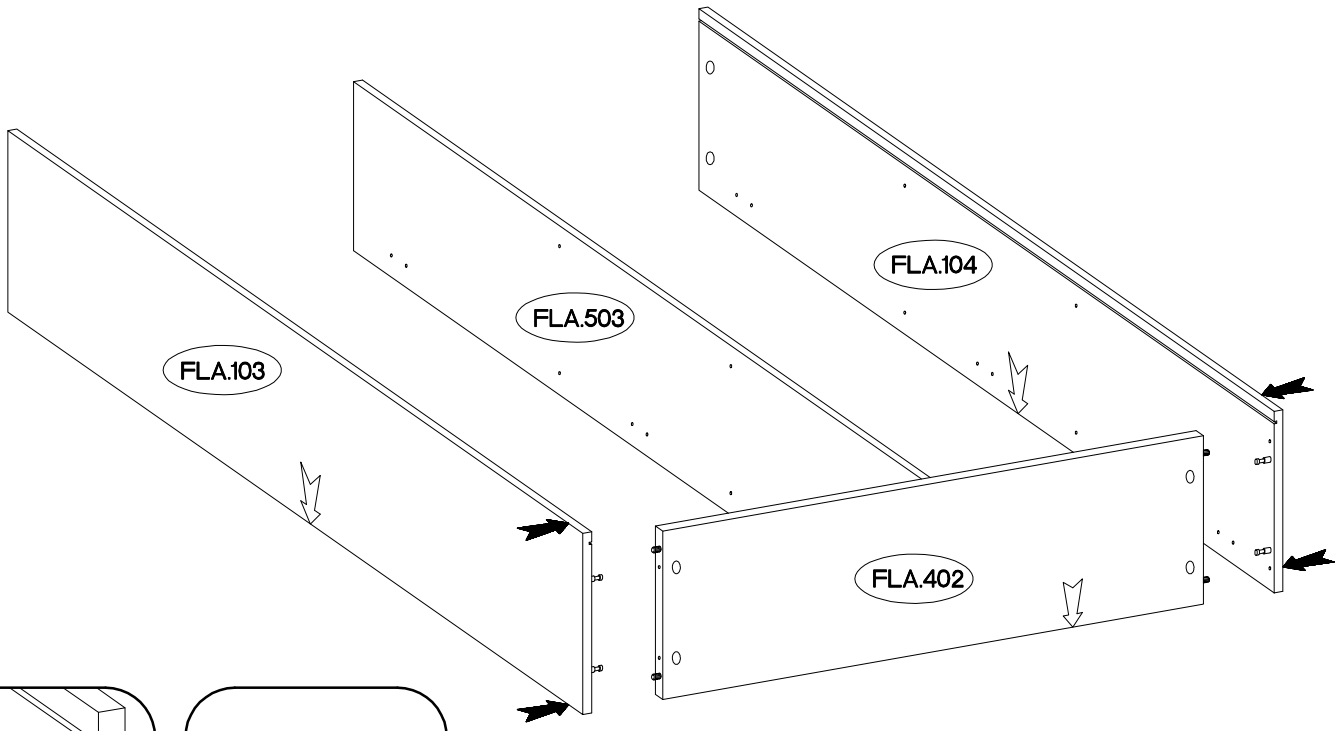

4

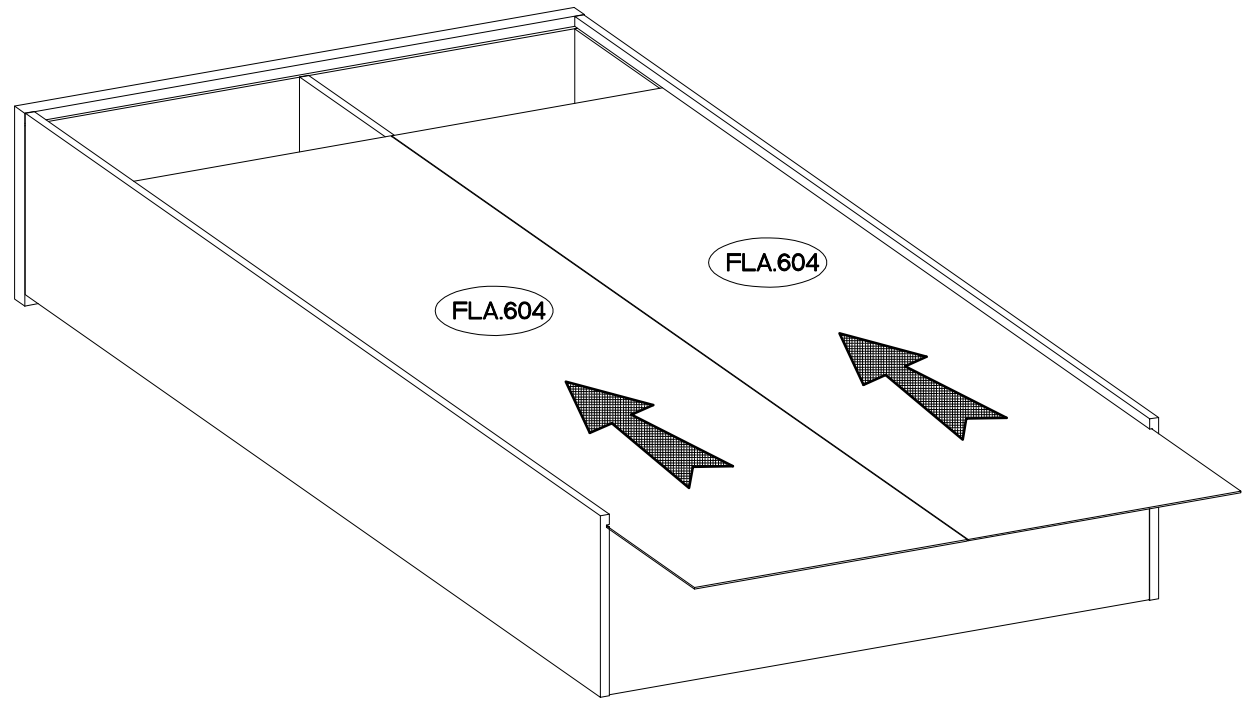
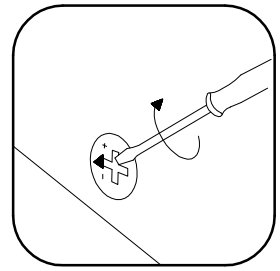
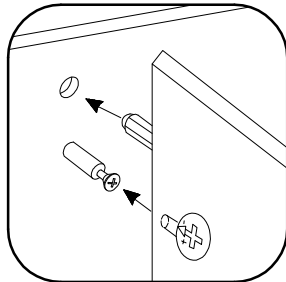
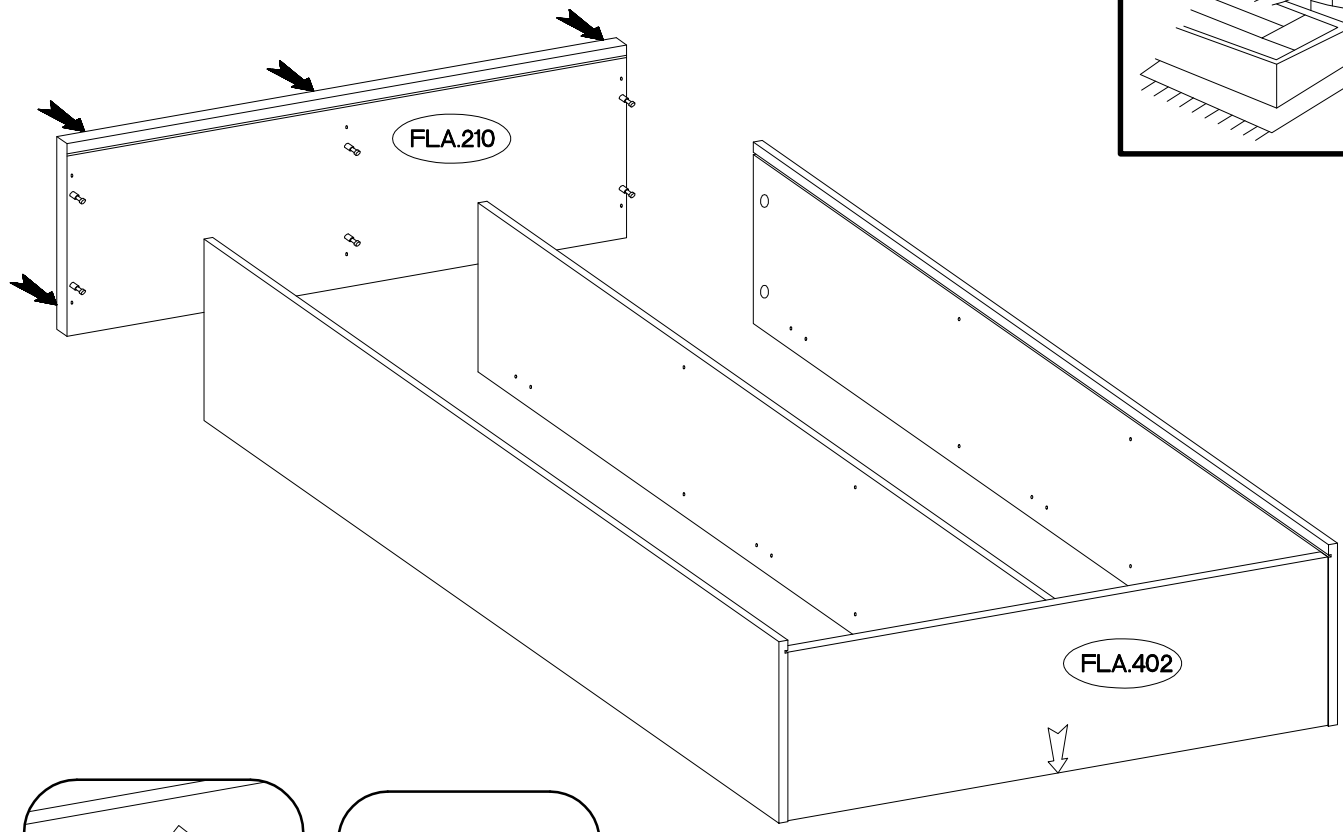
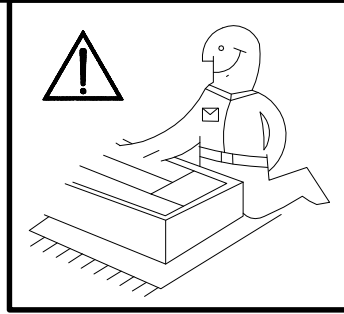

5





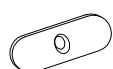

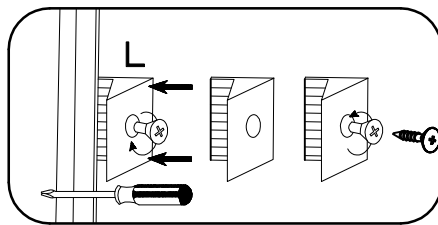
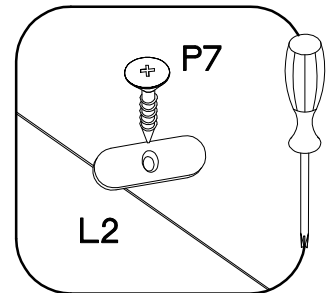
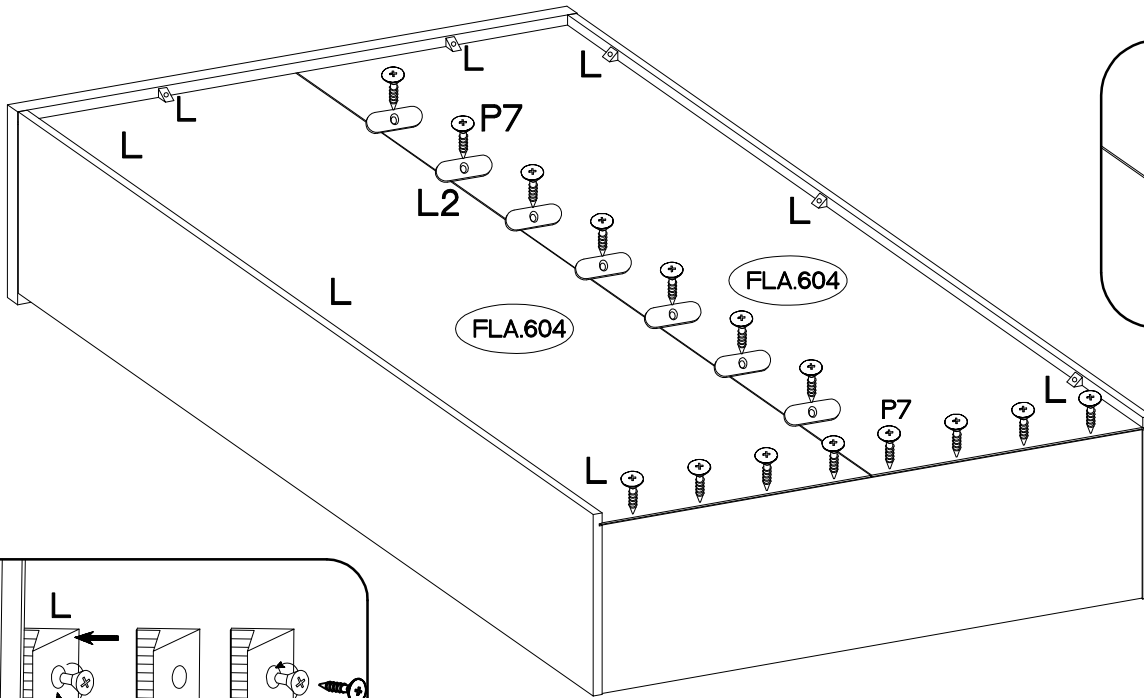
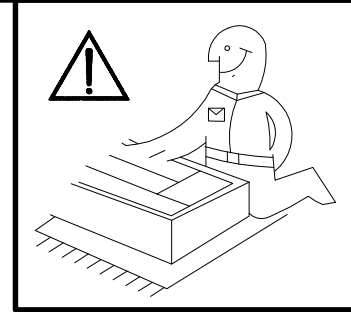
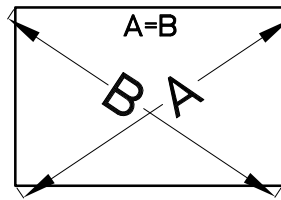
6

	$\pm 3.0 \times 20 \text{mm}$ 	
L	P7	L2
10	15	7

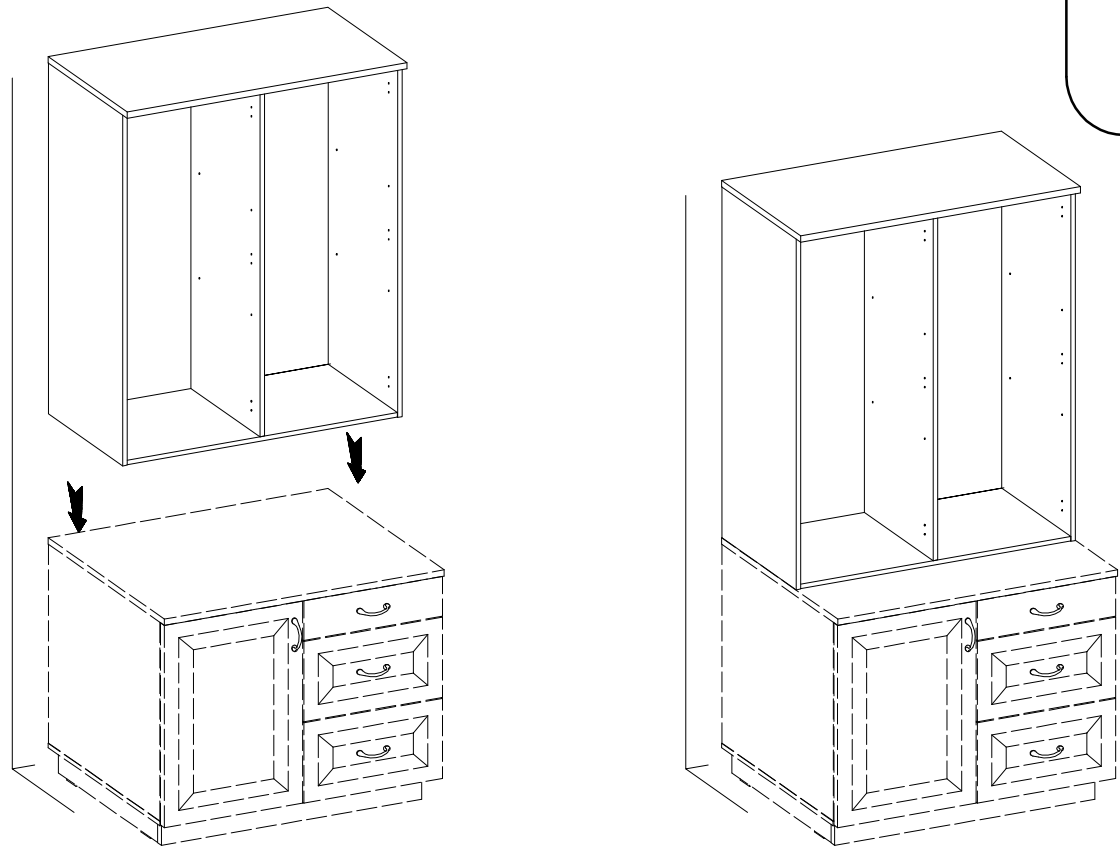
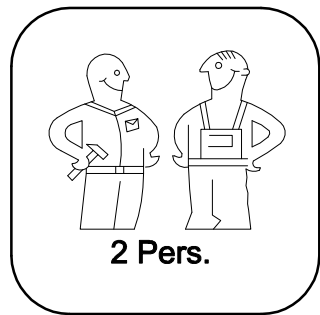

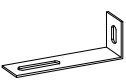

7

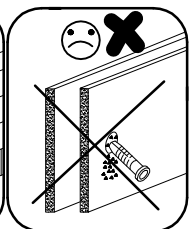
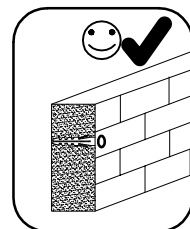
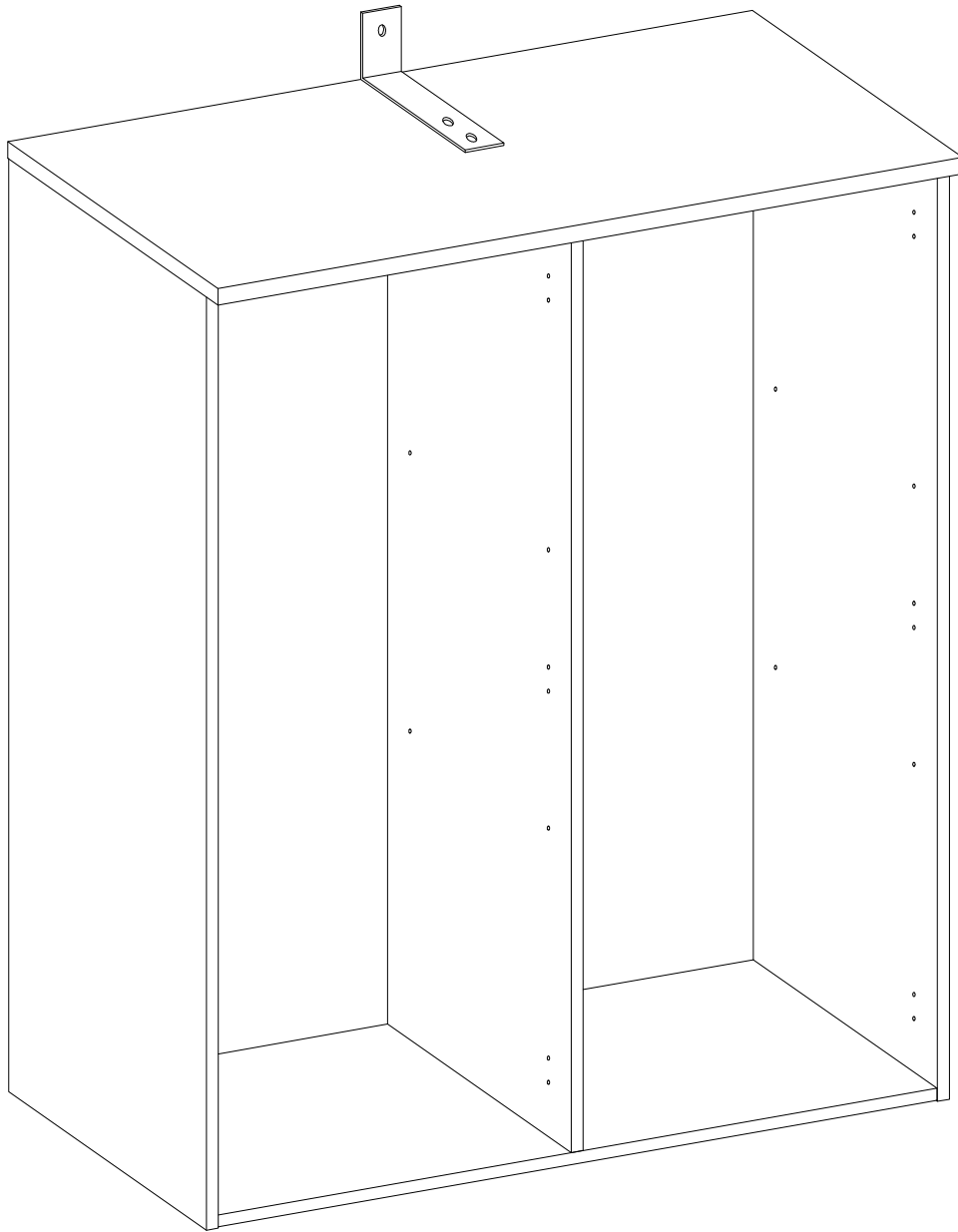
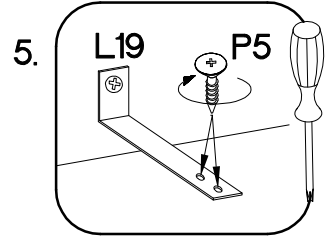
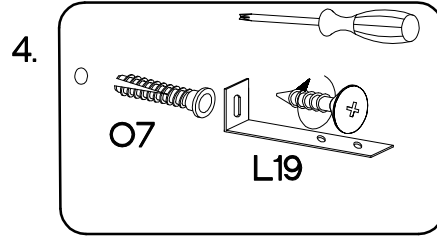
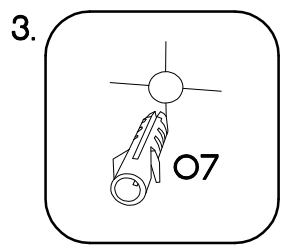
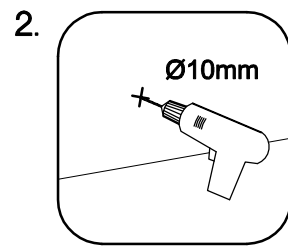
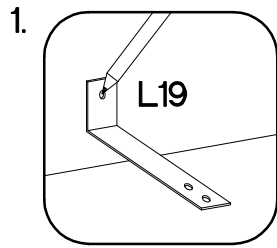

	↑3.5x13mm	↑5.0x60mm	↑10x50mm
			
L19	P5	P12	O7
1	2	1	1



9

±5/16mm		
	J3	E
16		10

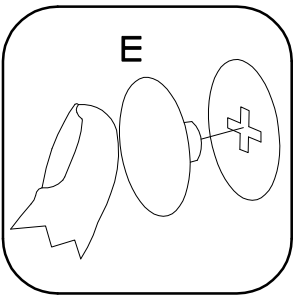
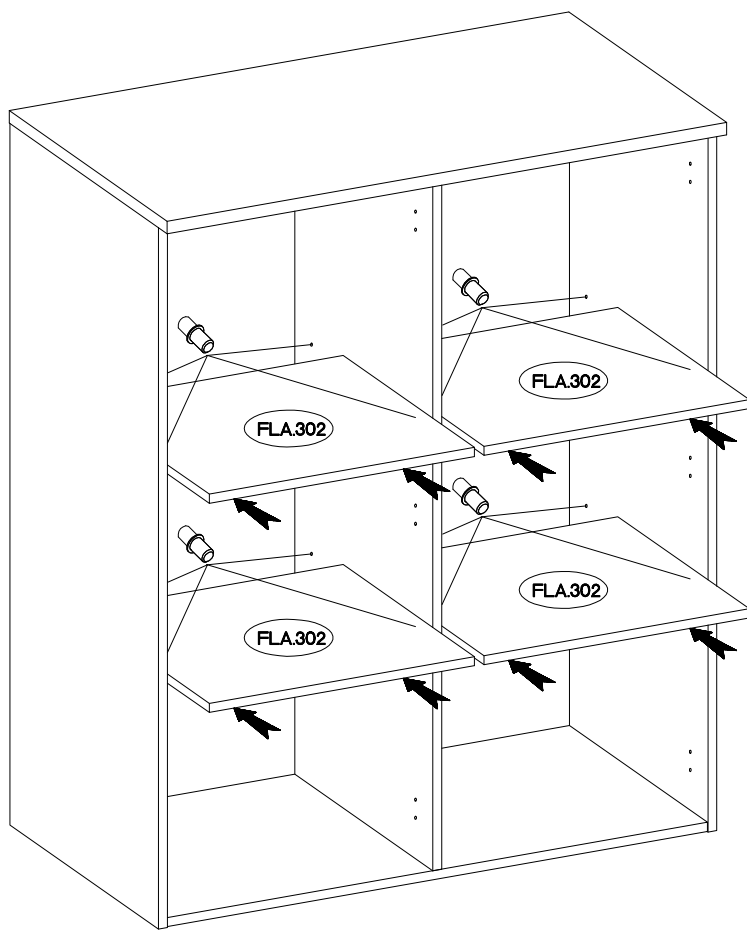
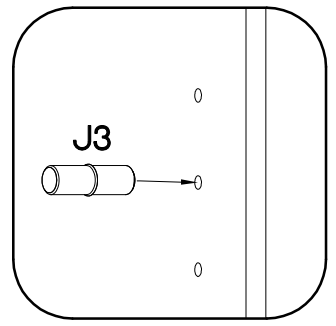

10

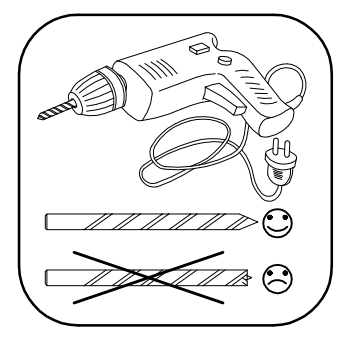
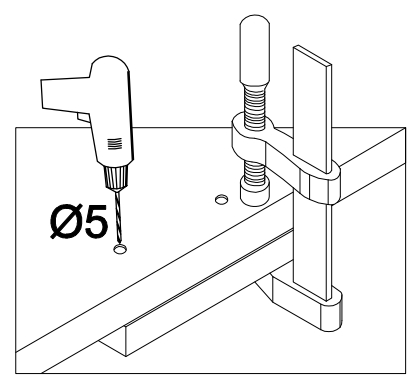
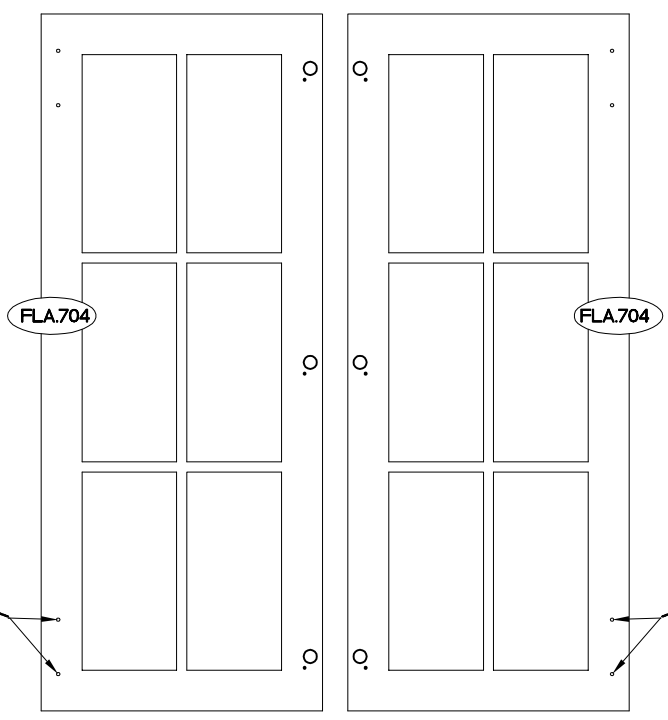

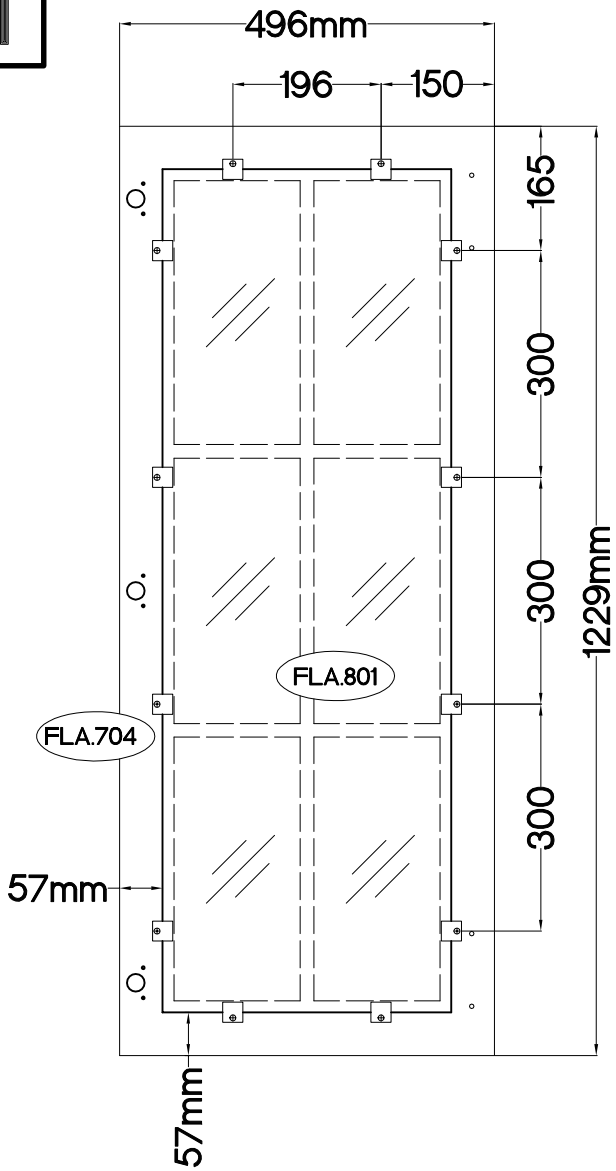

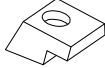

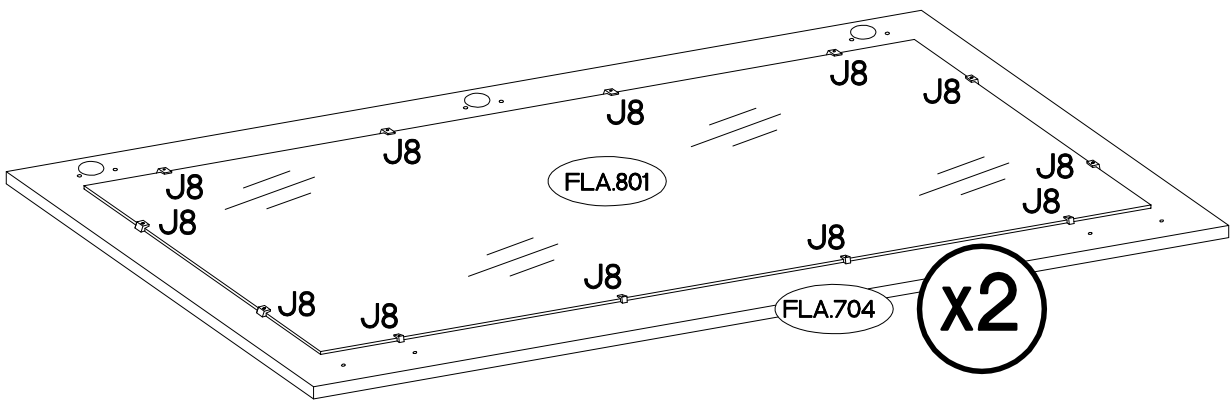
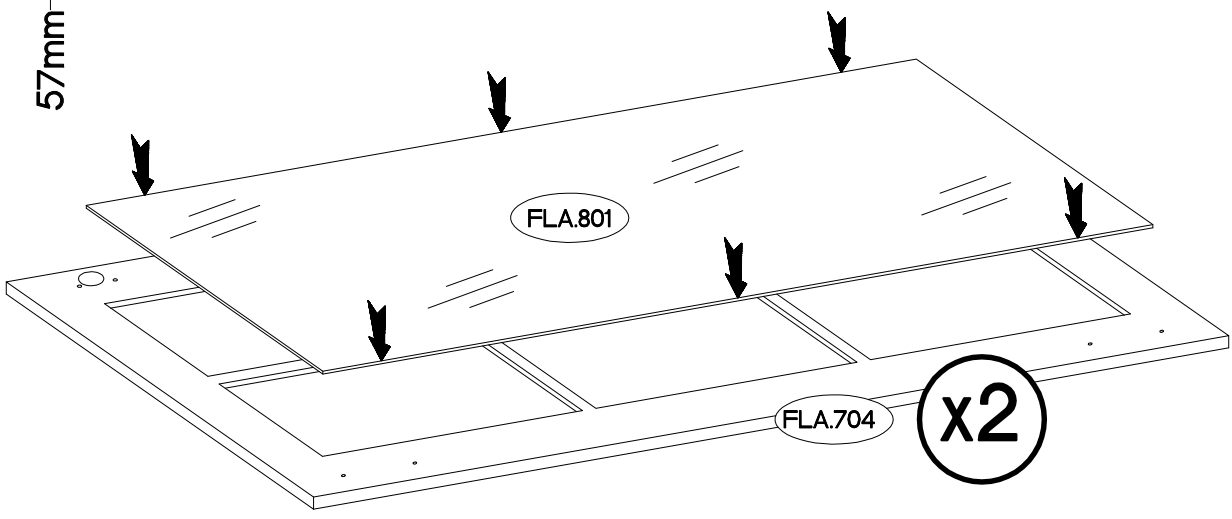
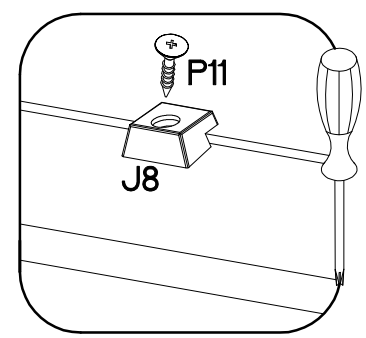
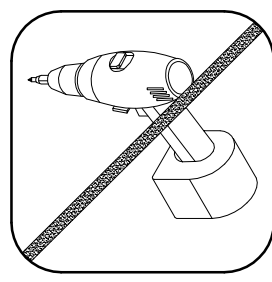
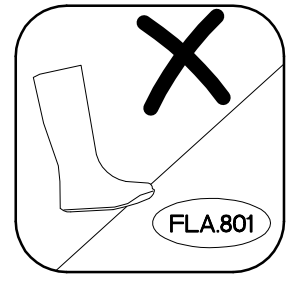
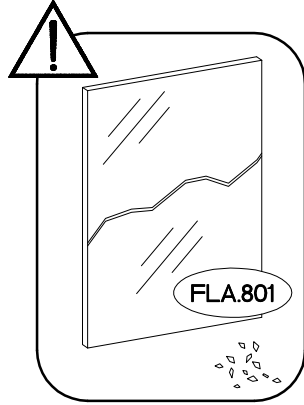
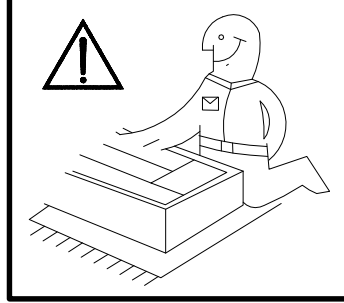
	$\pm 3.0 \times 16 \text{mm}$
J8	P11
24	24



12

±35/0mm  HG 6	±3.5x13mm  P5 12
--	---

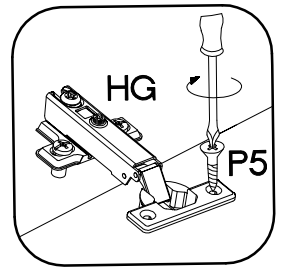
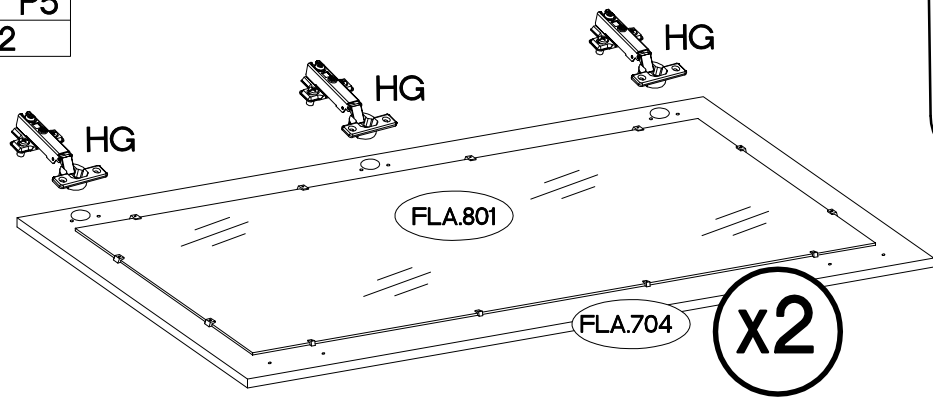

13

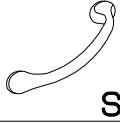
M4x22mm  U 4	 S 2
--	---

