

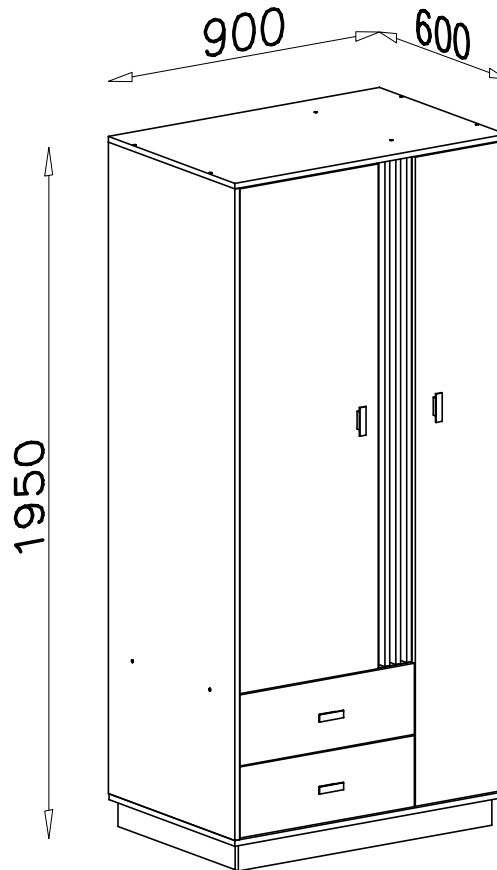

ALLMO AL 1

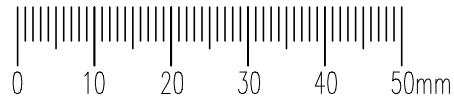
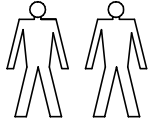
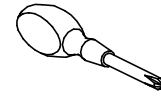
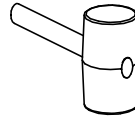
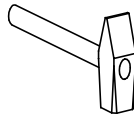
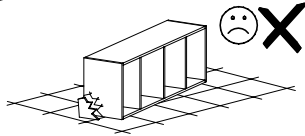
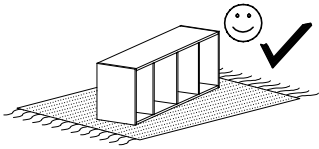

B2

 ø6x30 x24

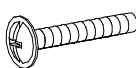
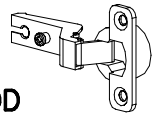
N13

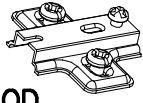
 M4x22 x8

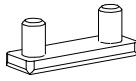
C4

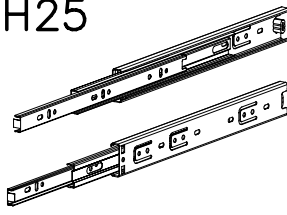
 Z350D x6

D4

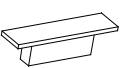
 PZ350D x6

P3

 x6

H25

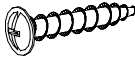
 400mm x2

E11

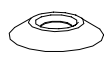
 x4

W1

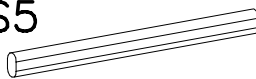
 GLUE, LEIM, LEPIDLO, LIM
 x3

G8

 4x30 x16

S2

 x12

S5

 574mm x1

G4

 4x16 x12

G2

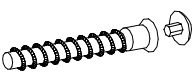
 3x20 x60

G6

 3x13 x2

G1

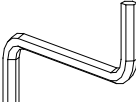
 4x13 x20

A1

 ø7x50 x28

B7

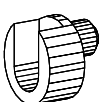
 ø8x30 x61

W2

 x1

F1

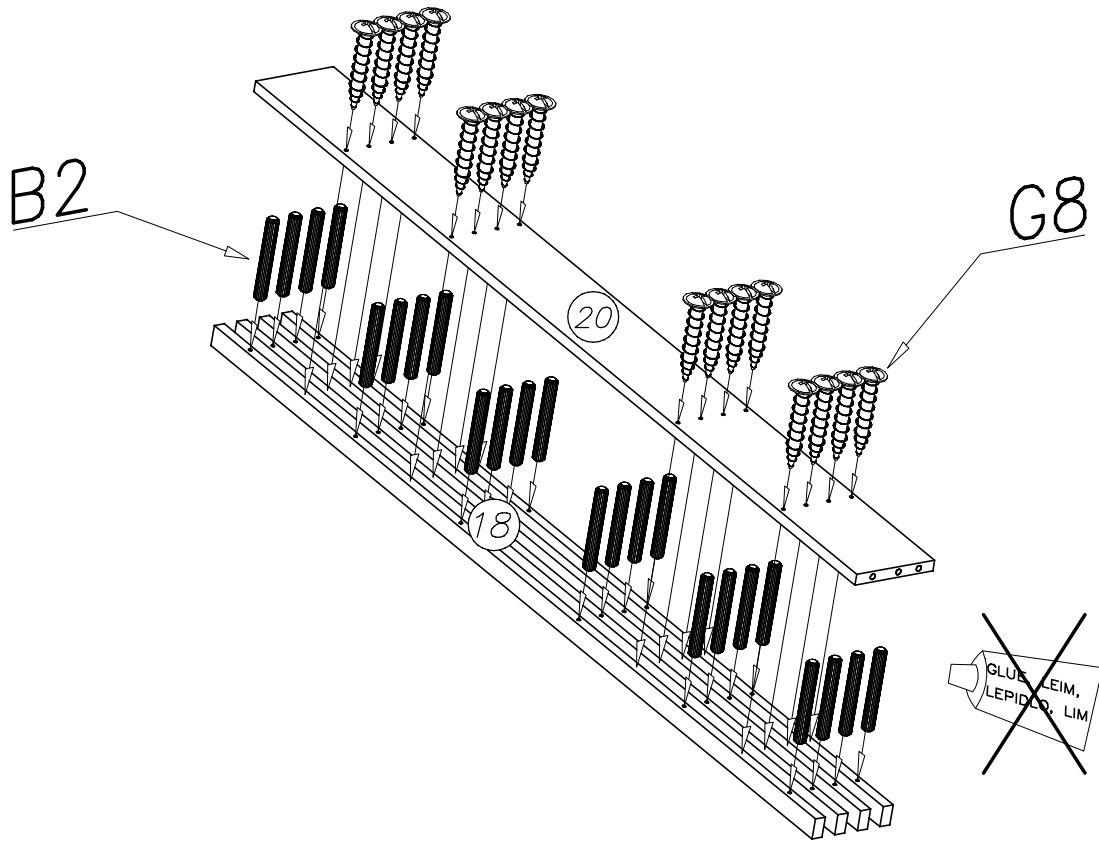
 x17

S4

 x2

I

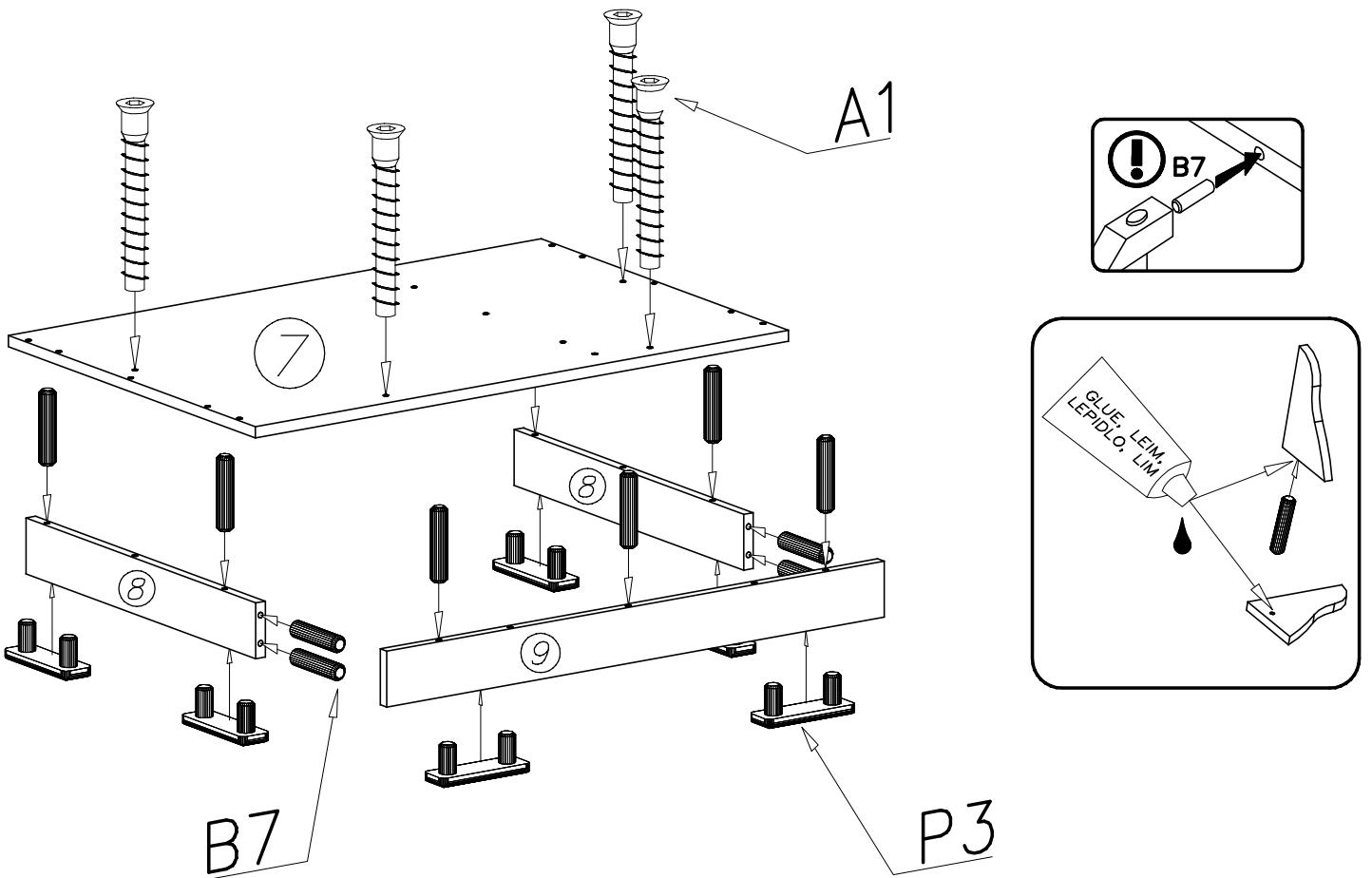

II

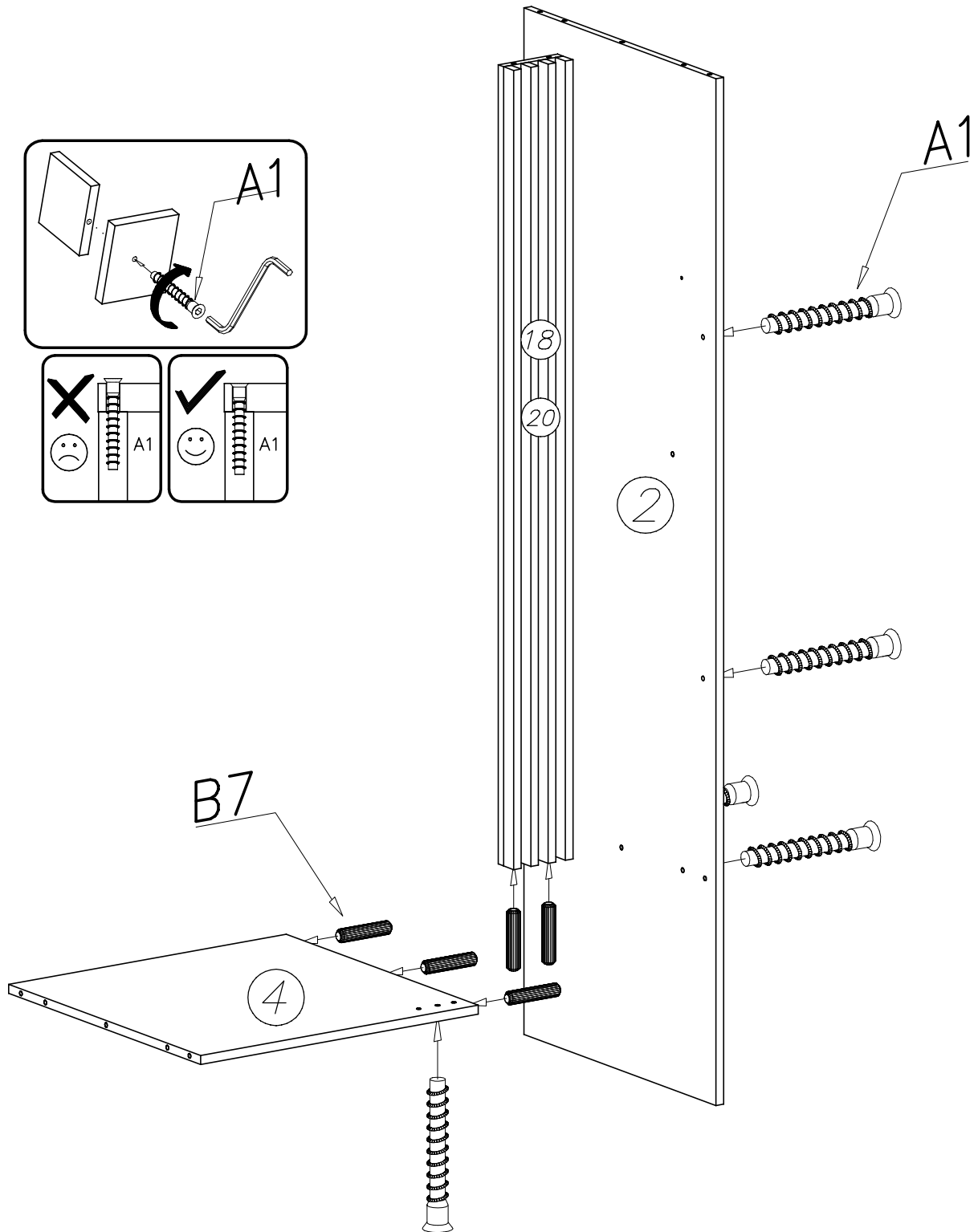
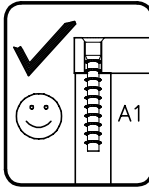
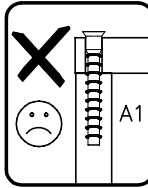
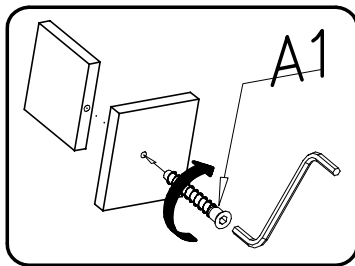
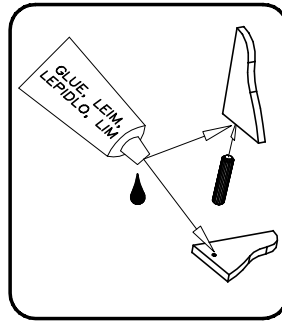
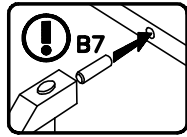



IV

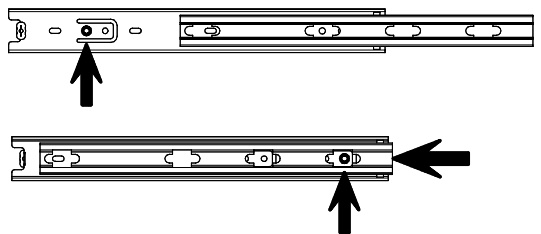
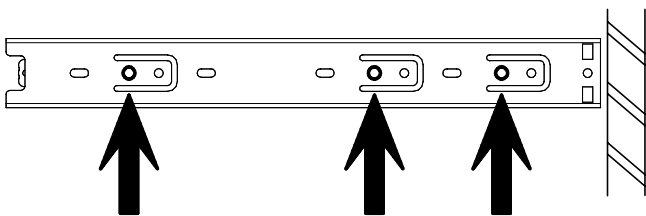
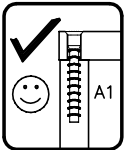
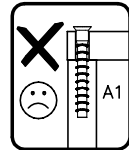
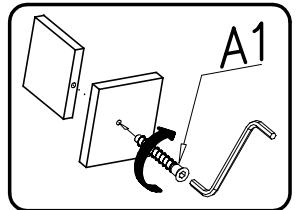
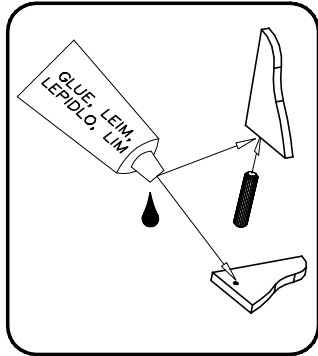
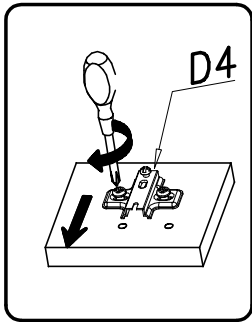
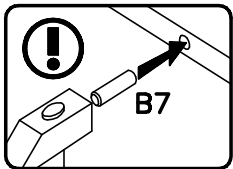
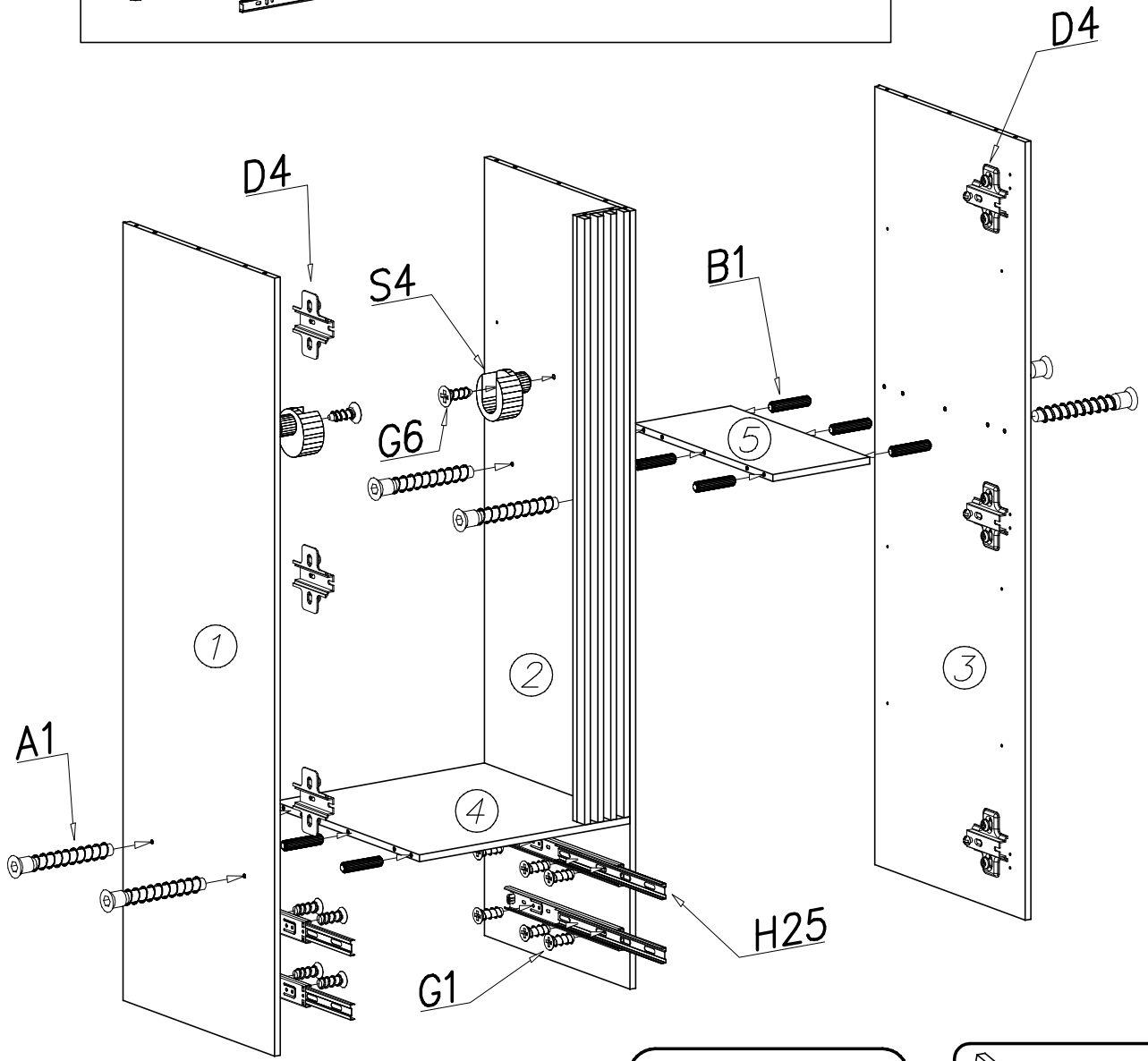
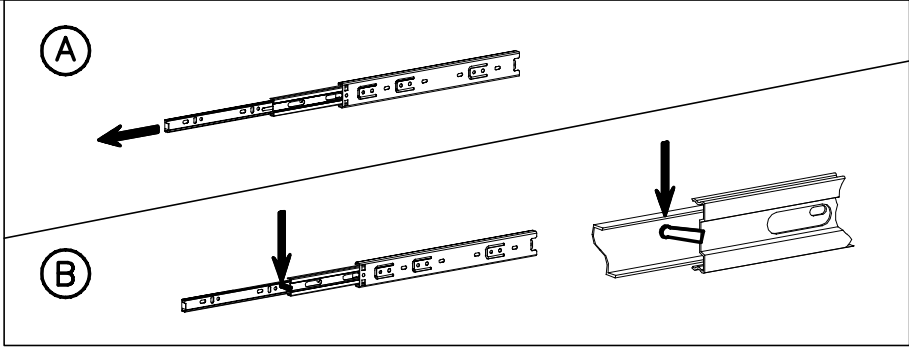

V

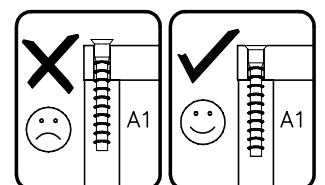
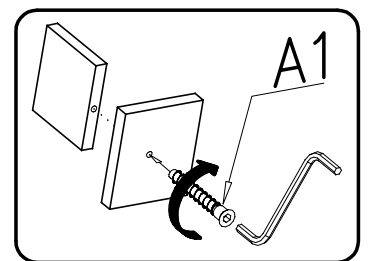
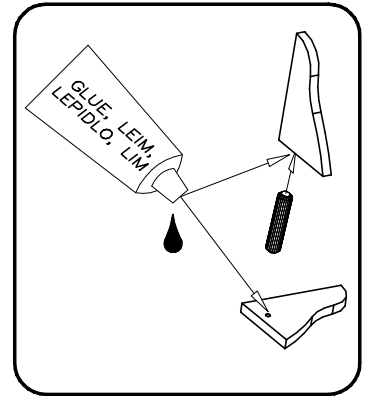
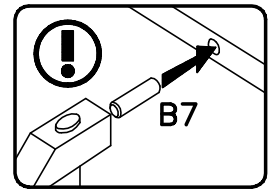
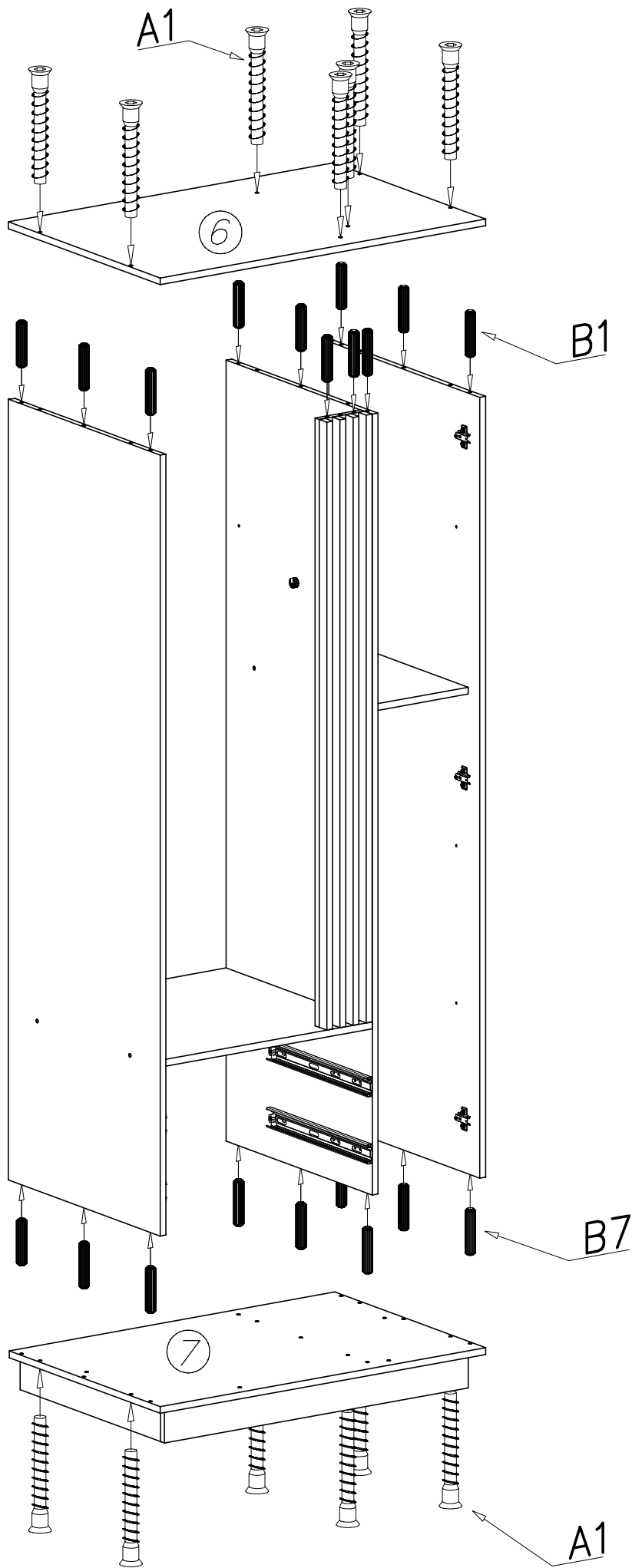

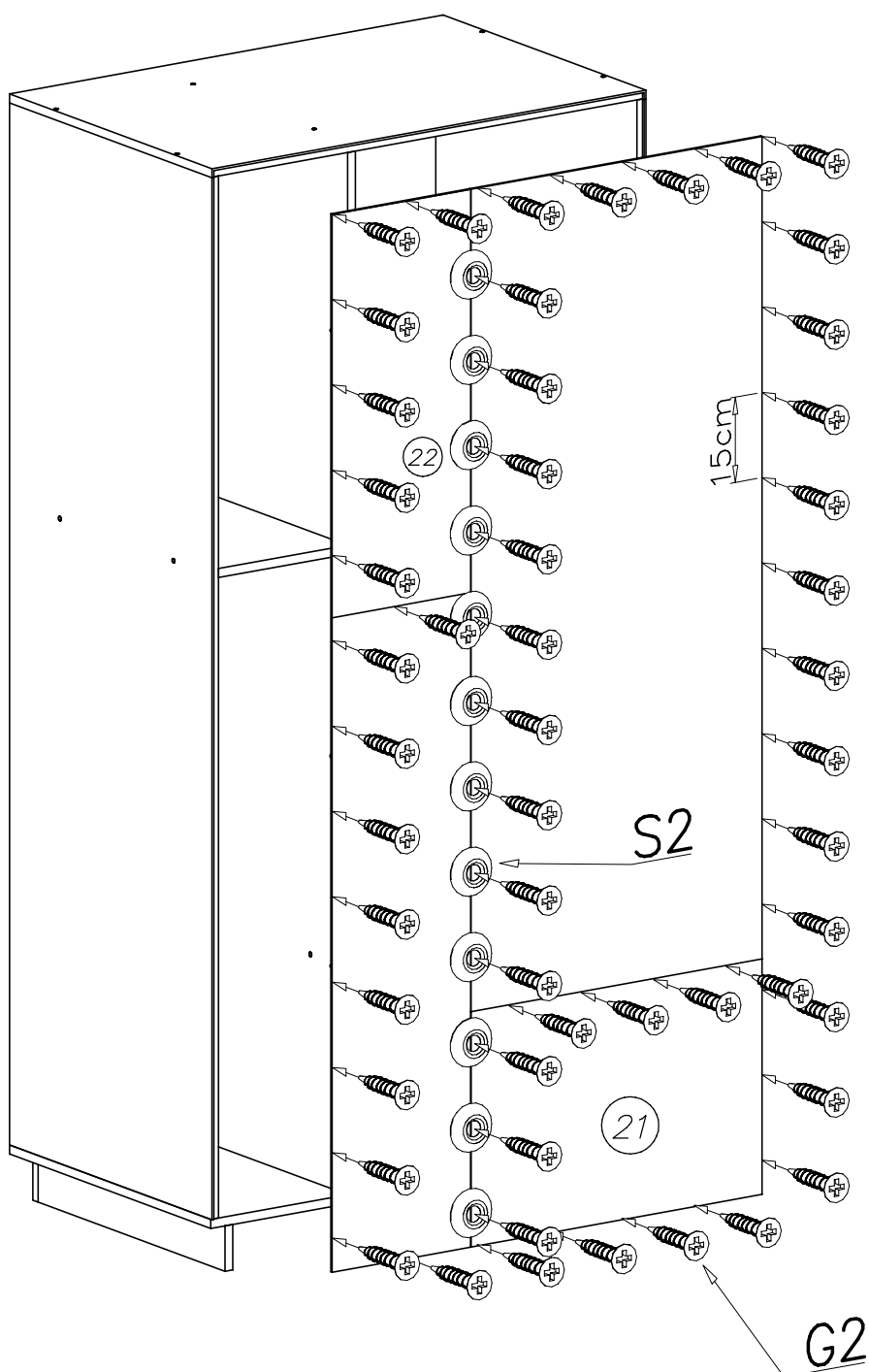
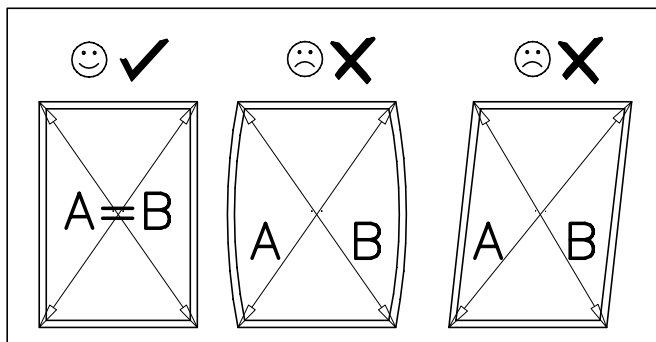

VII

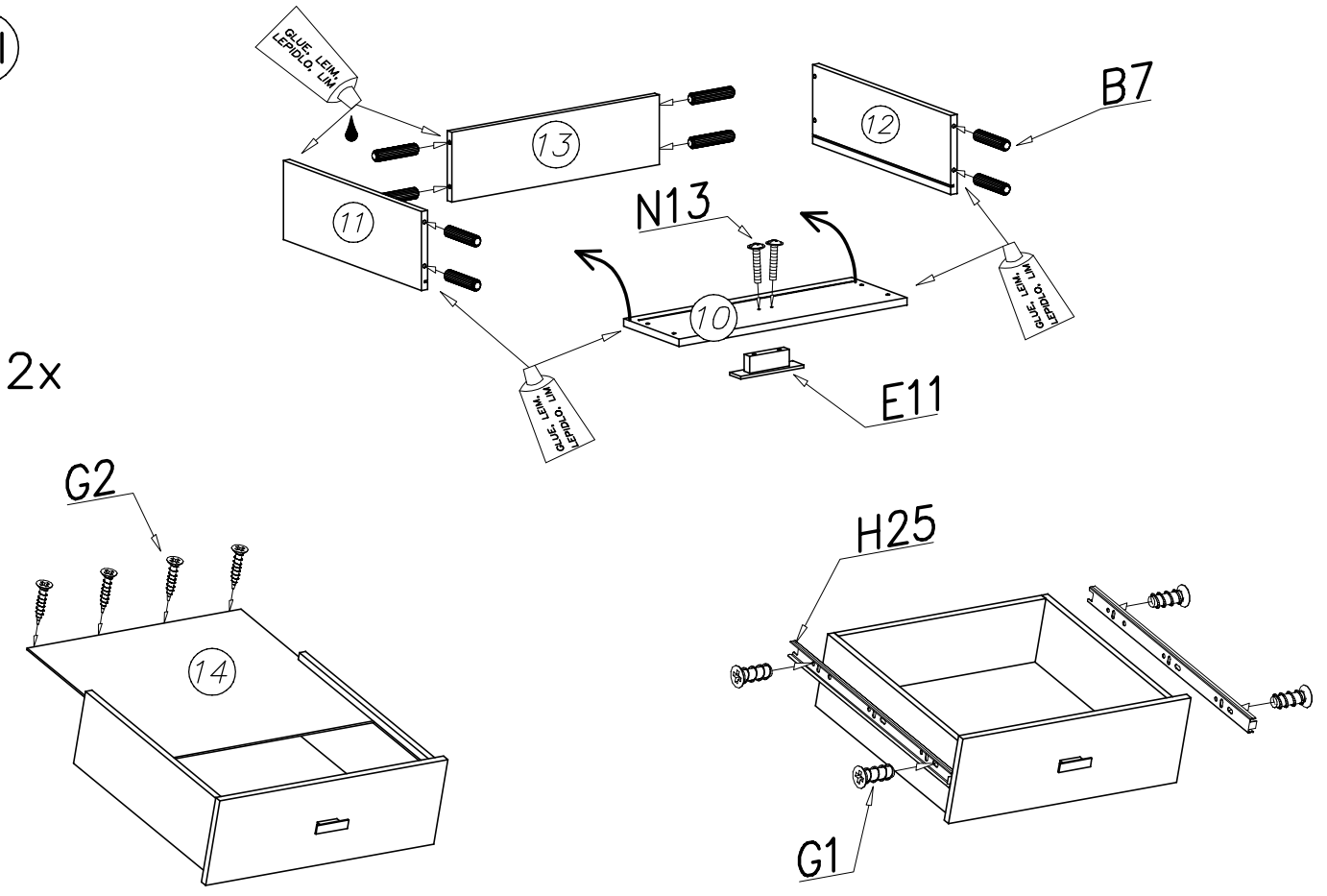

VIII

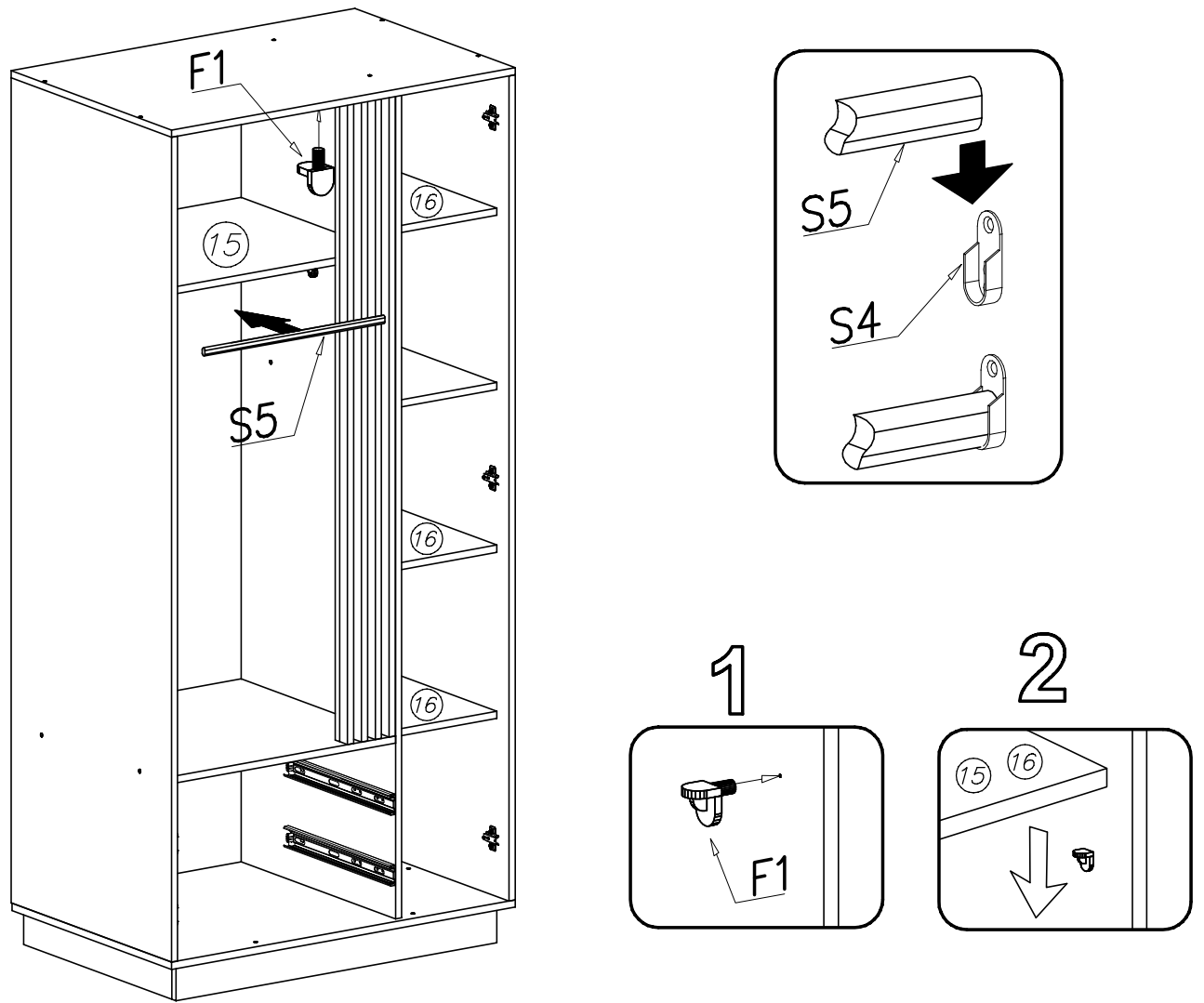

IX

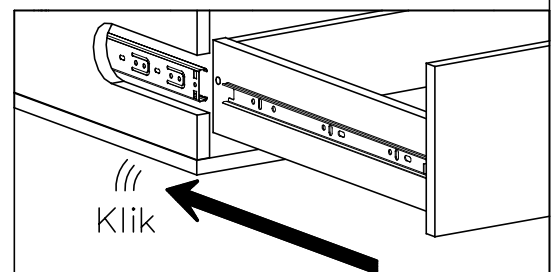
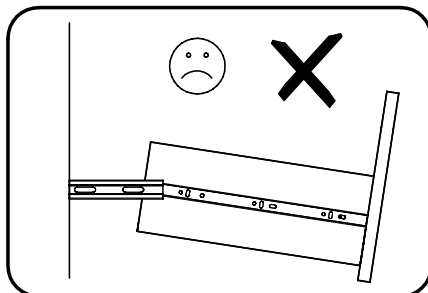
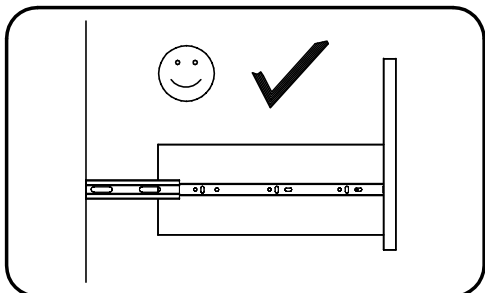
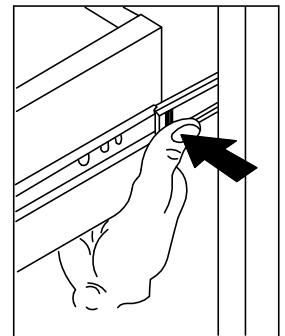
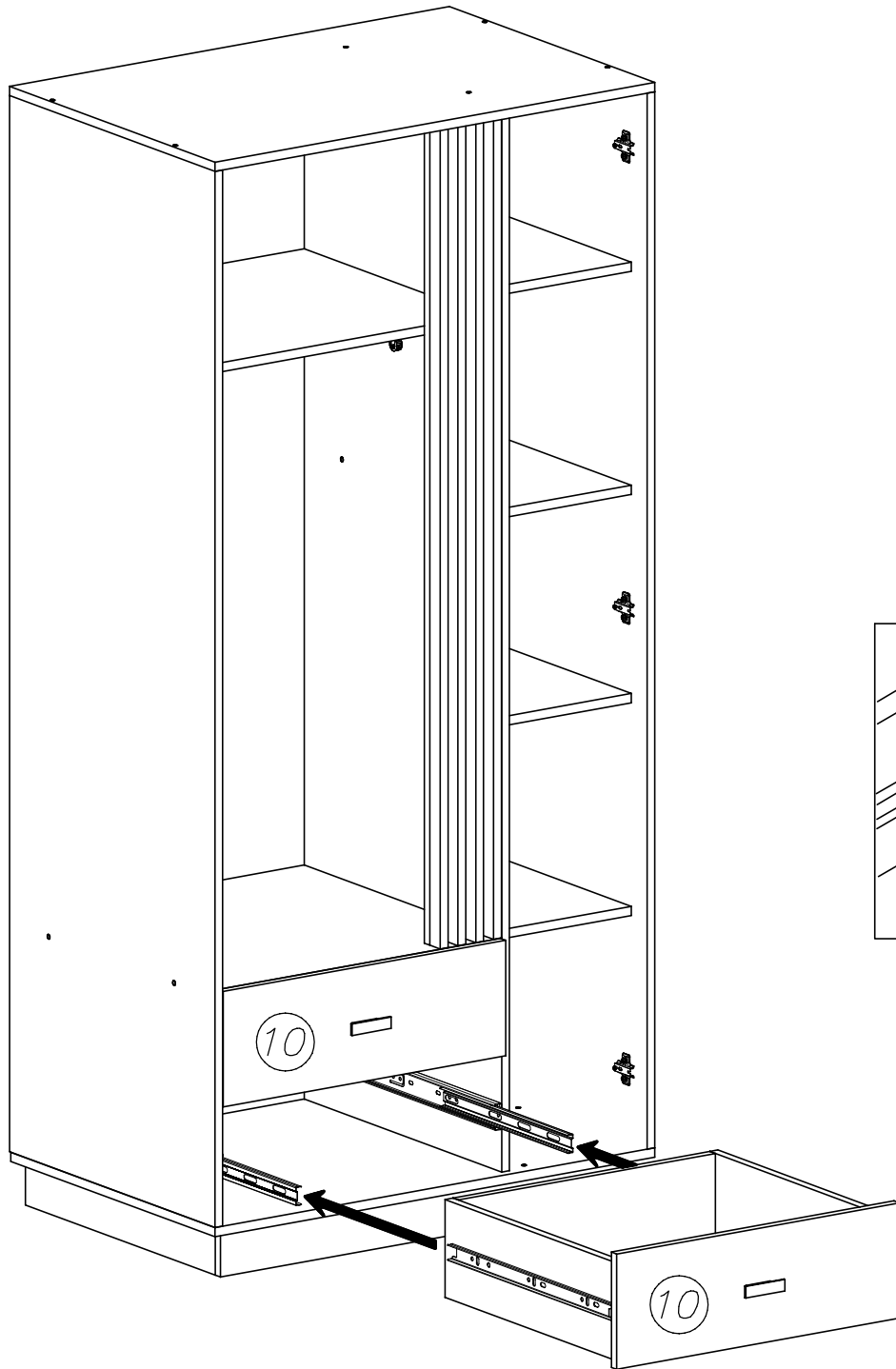

(X)

