





2

 A 16	 P9 10	 G6 5	 S1 3	 R2 6	 E4 5
---	--	---	---	---	---



BASIC  
+  
LUX

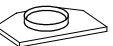
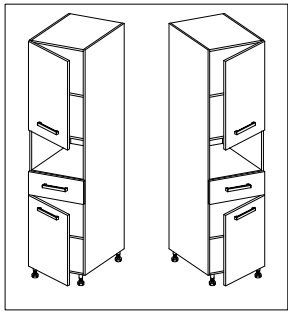
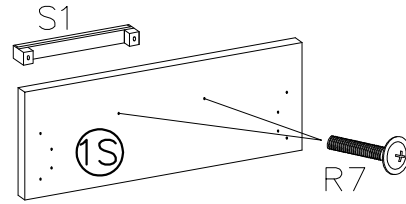
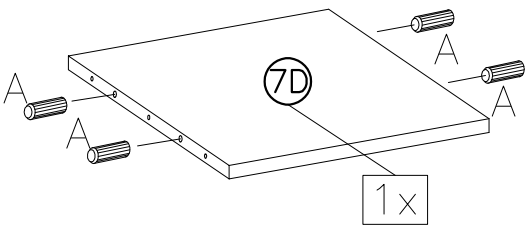
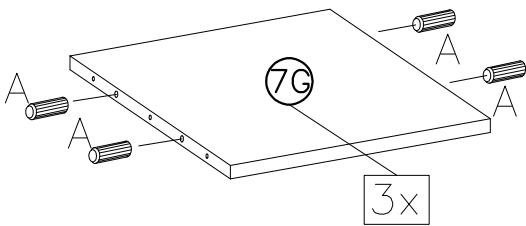

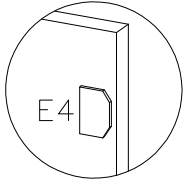
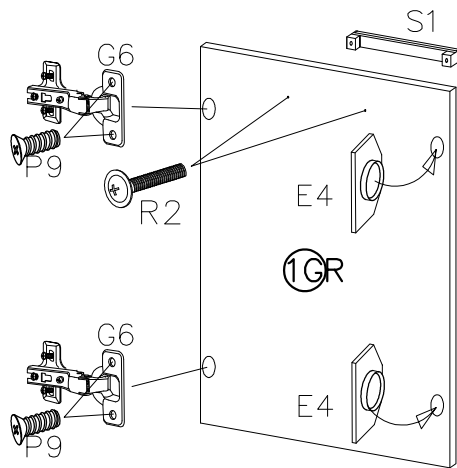
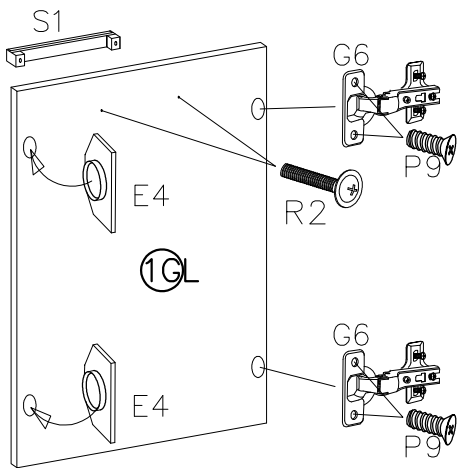
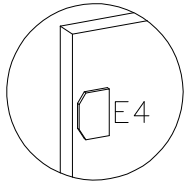
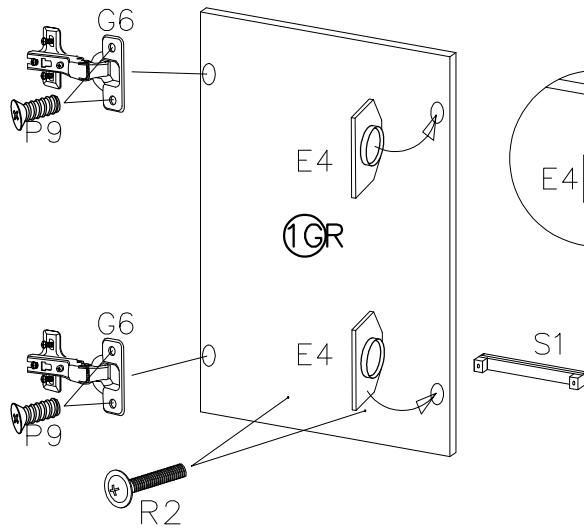
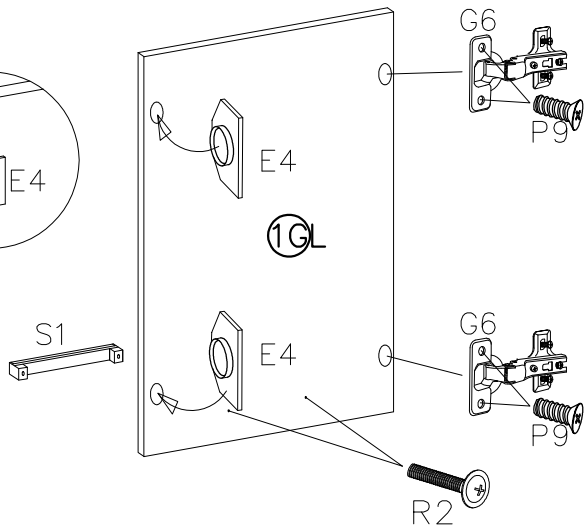
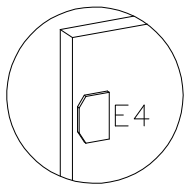
OPTION  
L-R



3

	
B	O
24	1



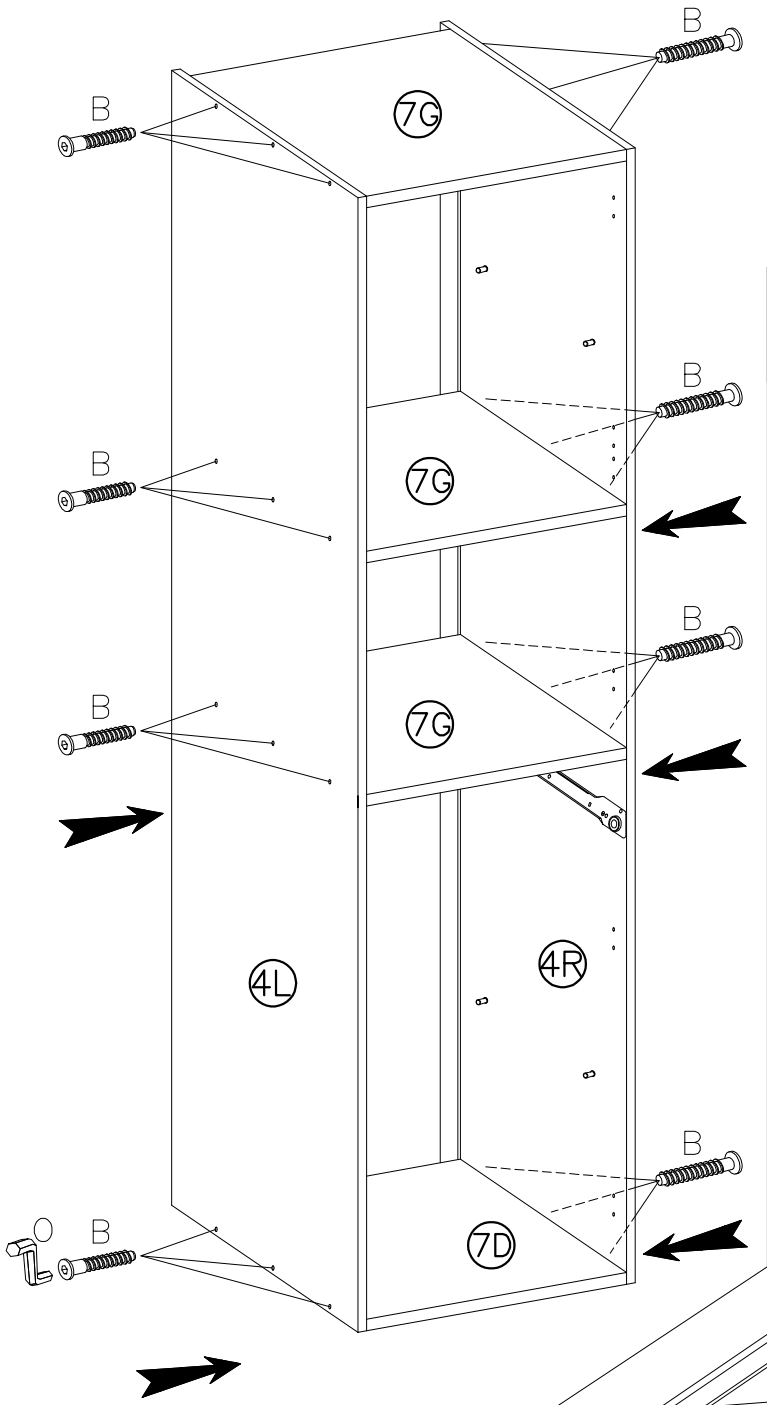

BASIC

+

LUX



4

		$\varnothing 3.5 \times 16 \text{mm}$		
F10	L		P4	F5
16	8		16	4+2

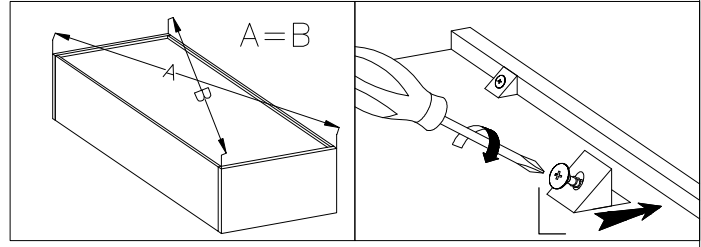

BASIC

+

LUX

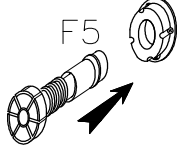
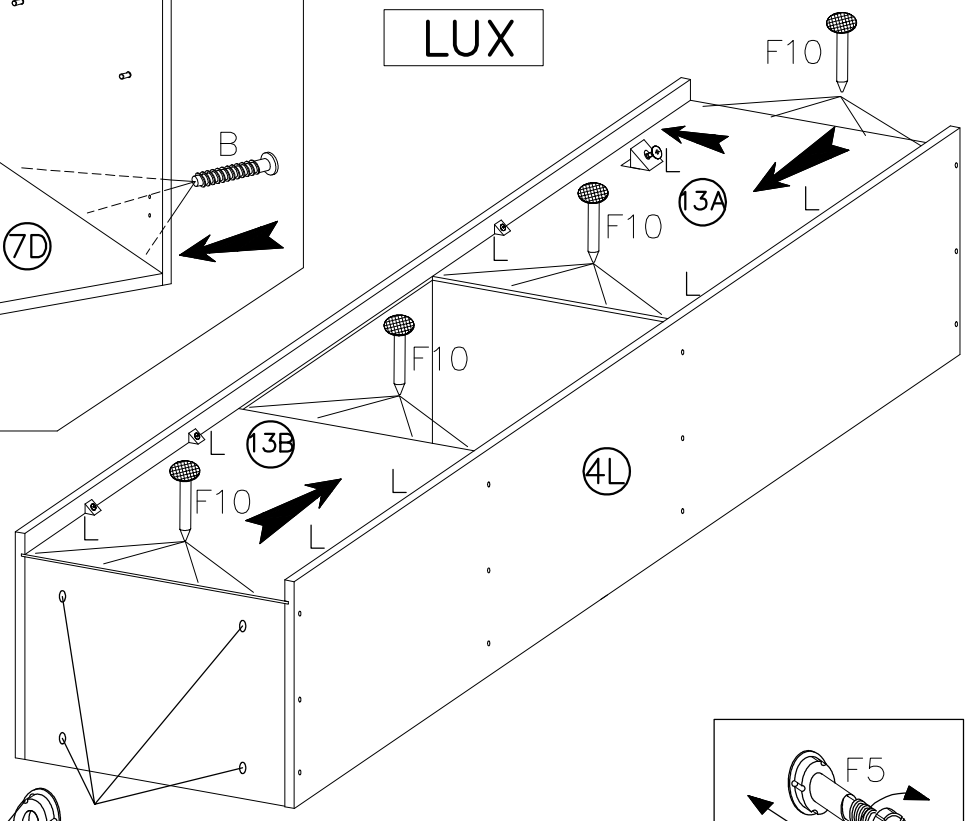

F5

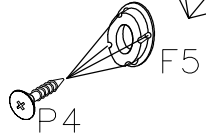
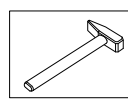

F5

P4

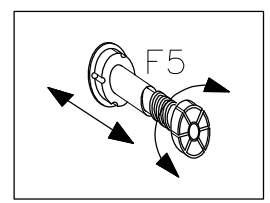

F5