



3

	
B	O
10	1





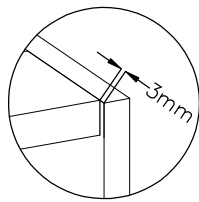

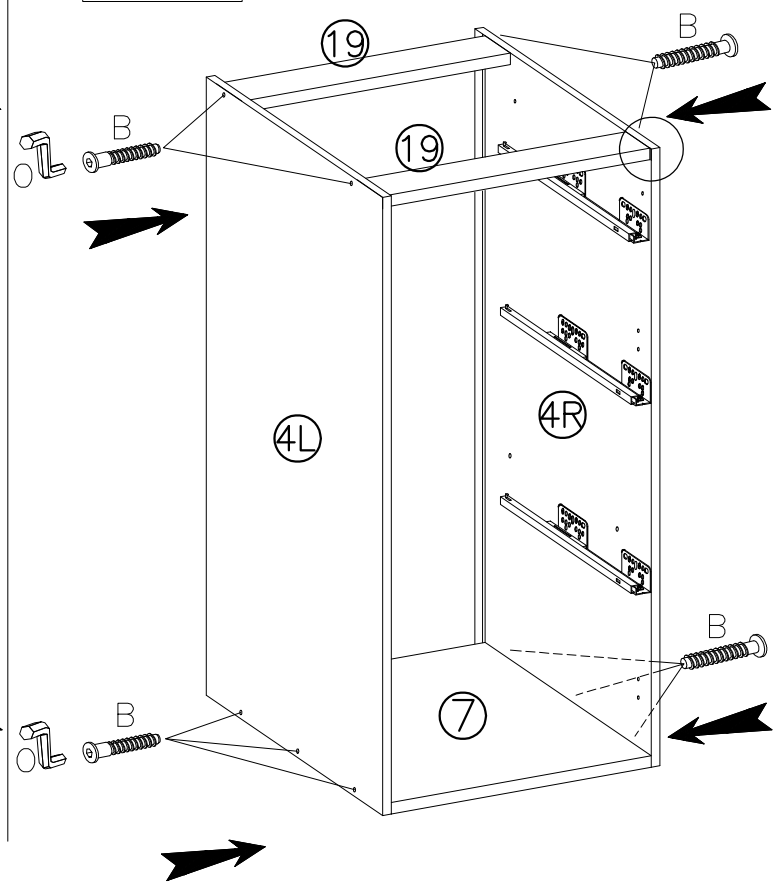
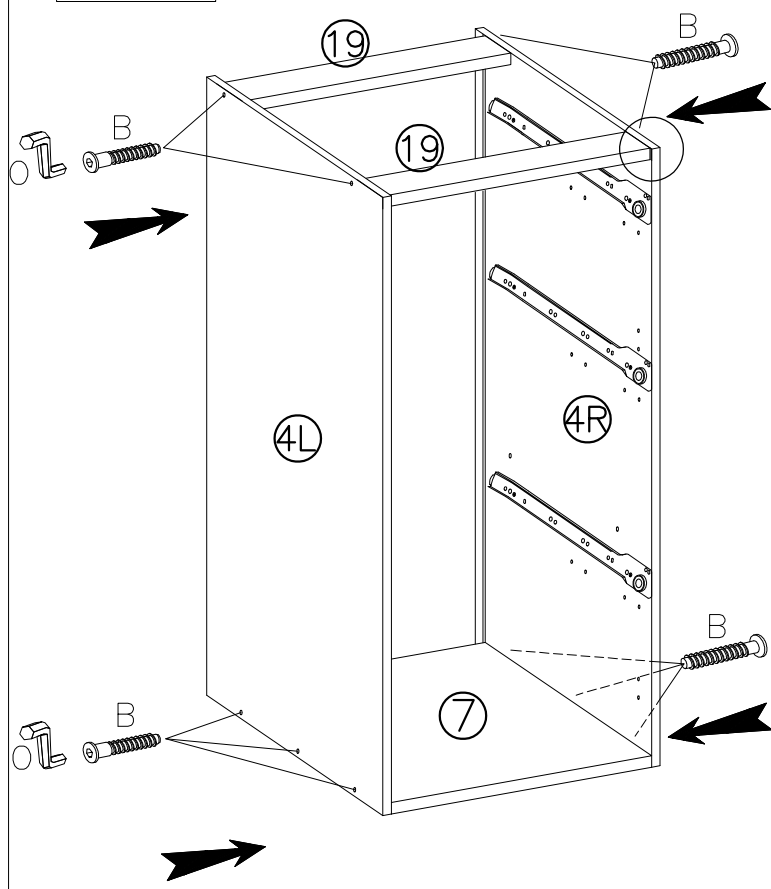
BASIC

LUX





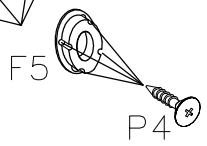
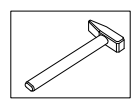
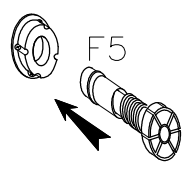
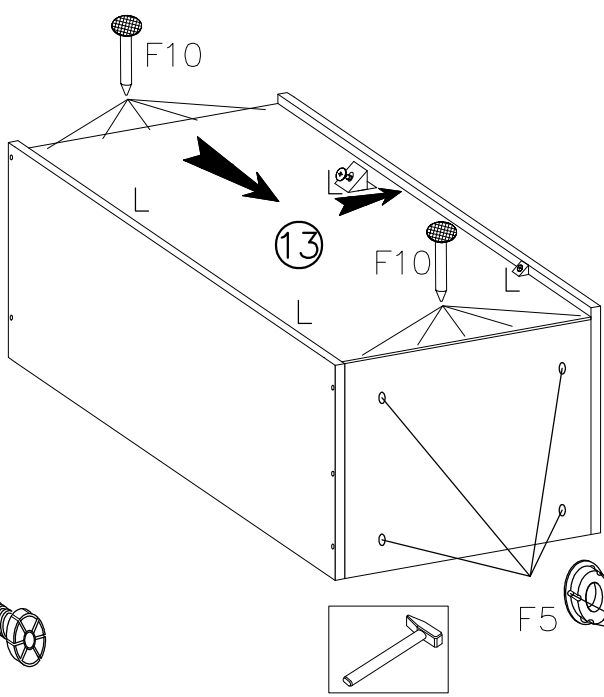
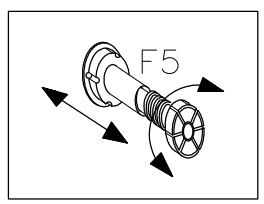
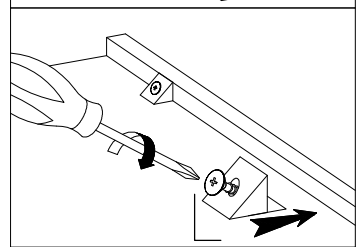
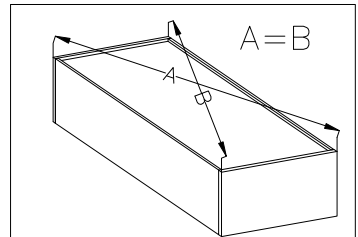

4

			
F10	L	P4	F5
10	4	16	4+2

BASIC
+
LUX

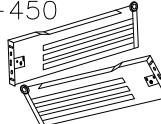

5

L-450  PR 3KPL	ø3.5x16mm  P4 54	 C3 3	 S1 3	M4.0x27mm  R2 6
---	--	--	--	---

BASIC

