

60 DKPL-162 1F
BB

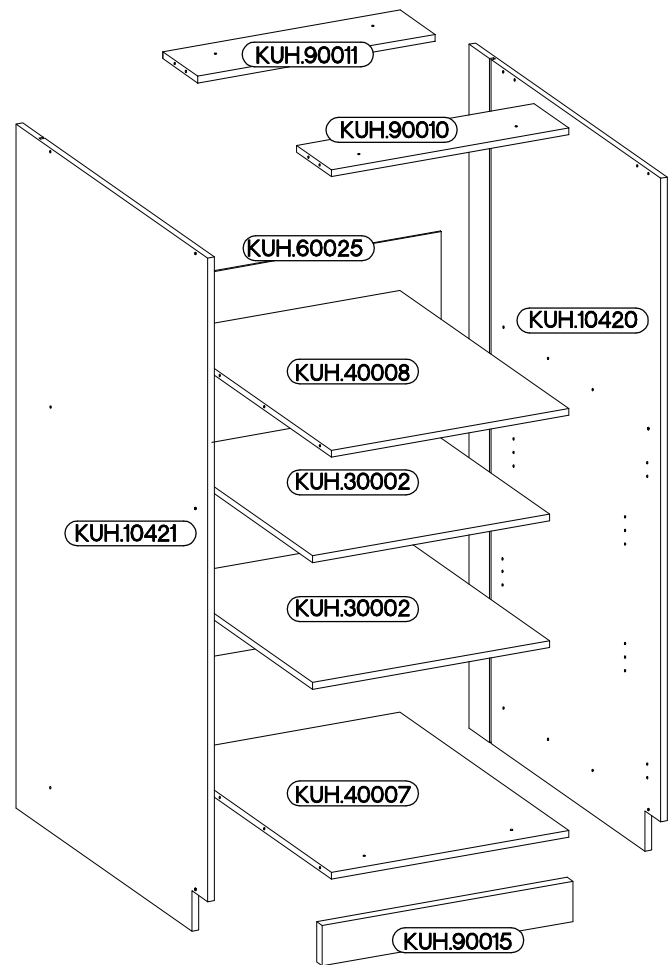

 ±8x30mm A	 6,4 x 50mm B	 E1	 E9	 6.5x48x16 F2	 ±35/0mm [CD] HG	 ±5/19mm J
12	12	12	2	4	2	8
 120x30x15mm L25	 O	 ±4.0x45mm P4	 ±3.5x13mm P5	 ±3.0x20mm P7	 ±4.0x25mm R	
1	1	2	6	8-10	4	

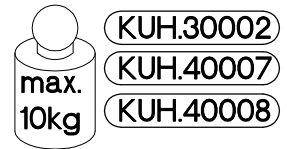
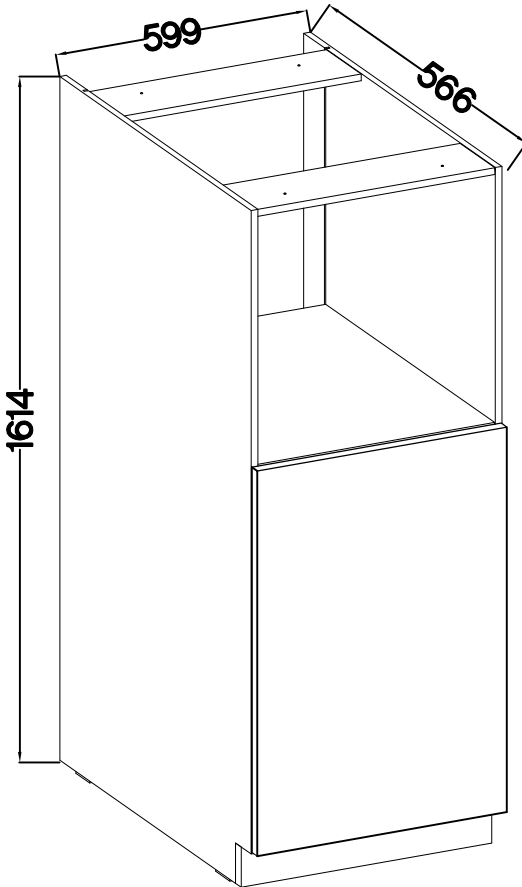
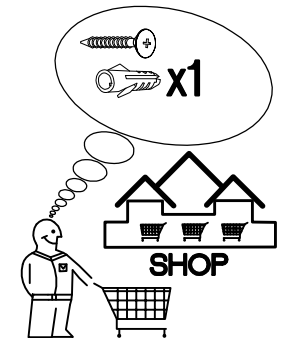

ISM-KUH-01624

1

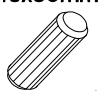
6.5x48x16	+8x30mm
	
F2	A
4	12

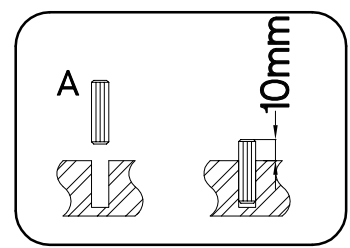
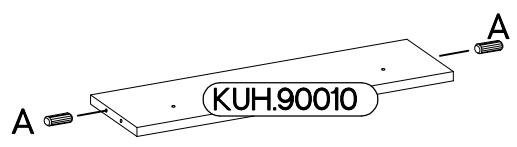
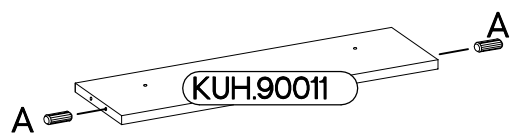
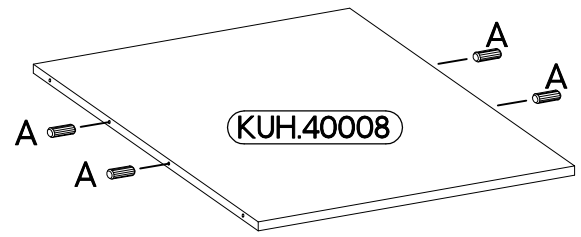
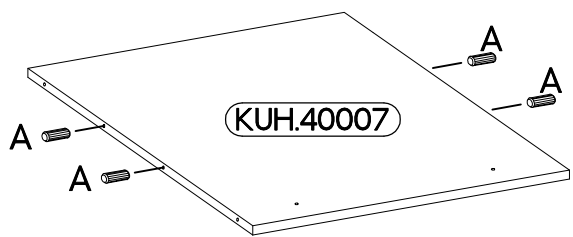
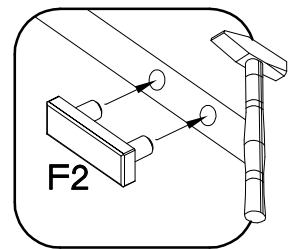
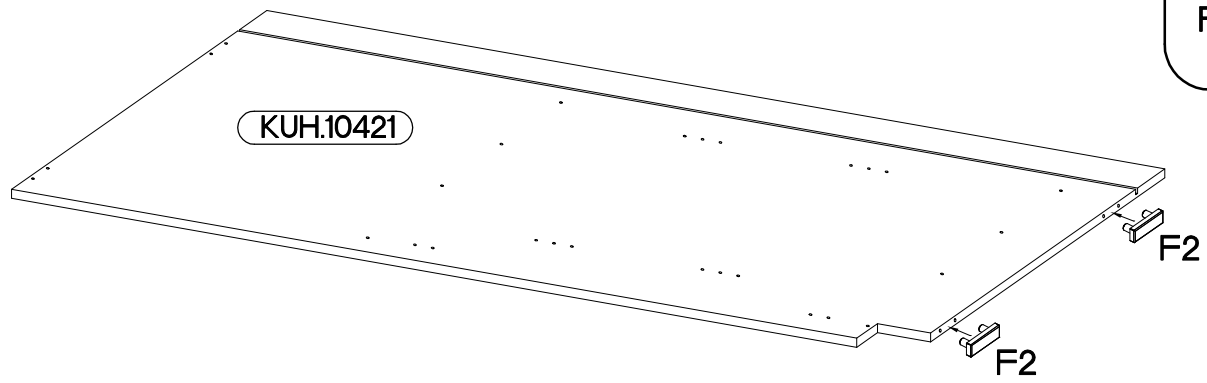
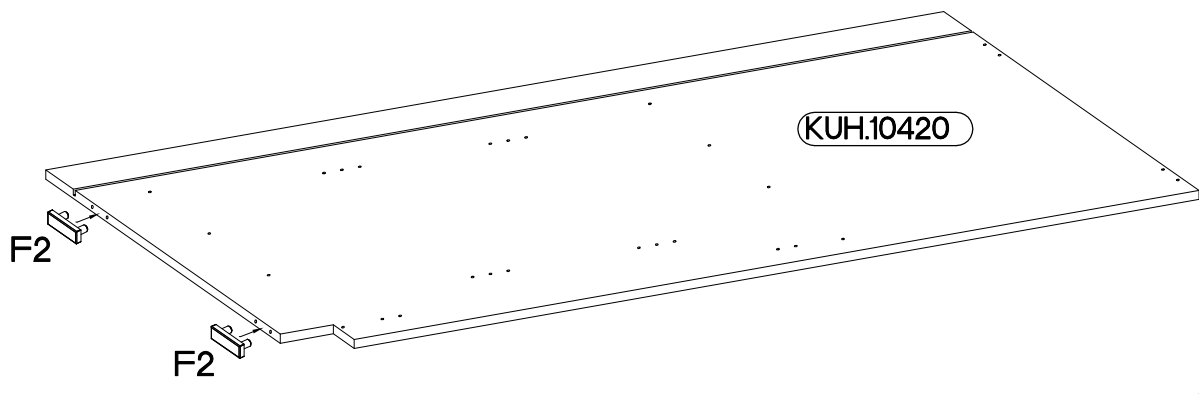
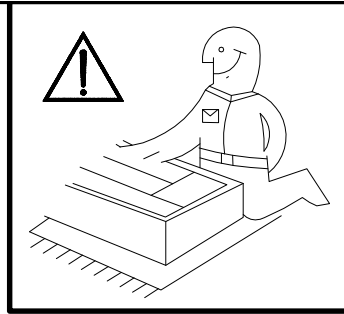

2

6,4 x 50mm

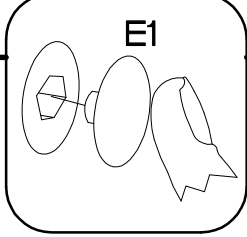
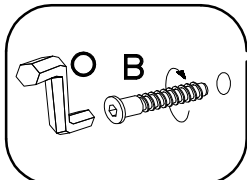
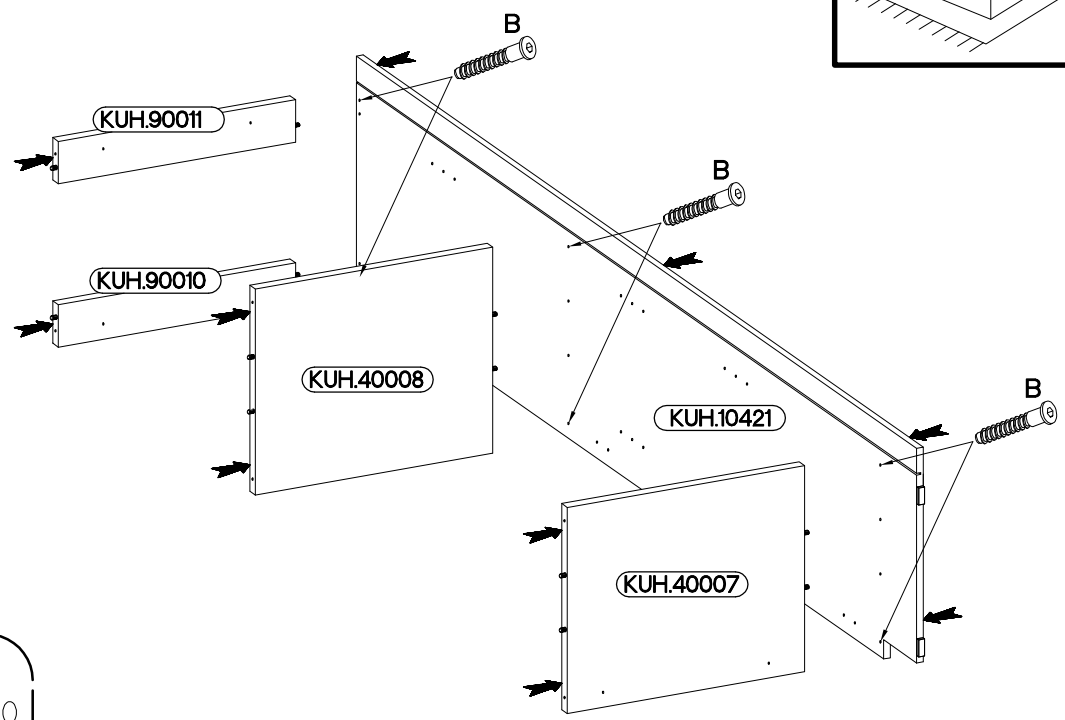
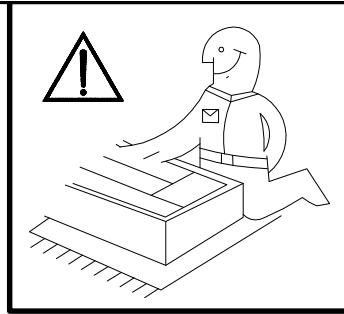
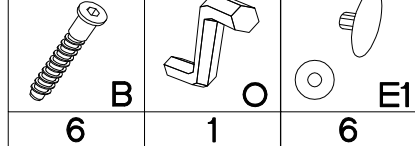

3

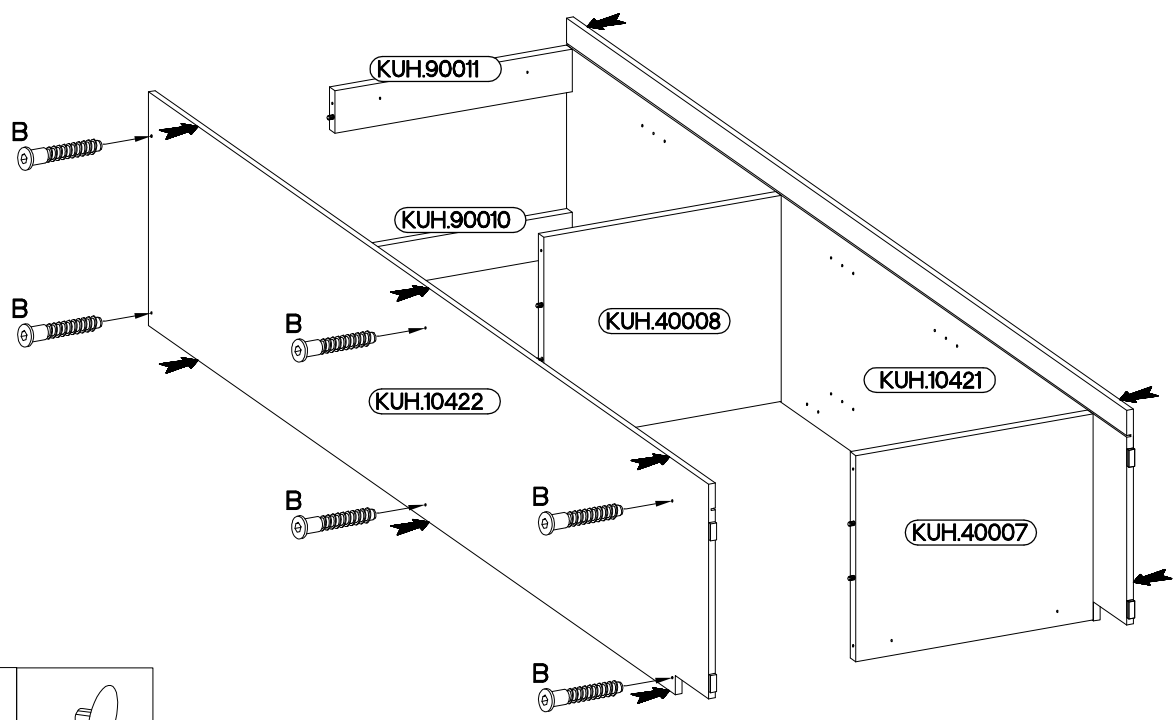

6,4 x 50mm

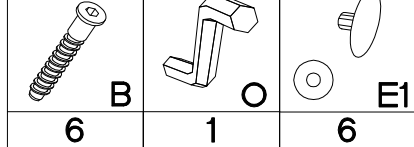

4

±3.0x20mm



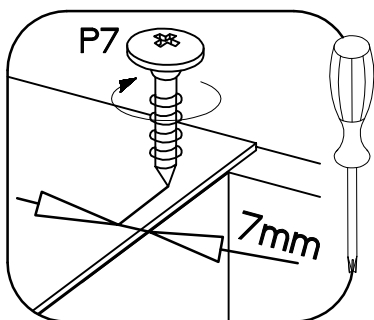
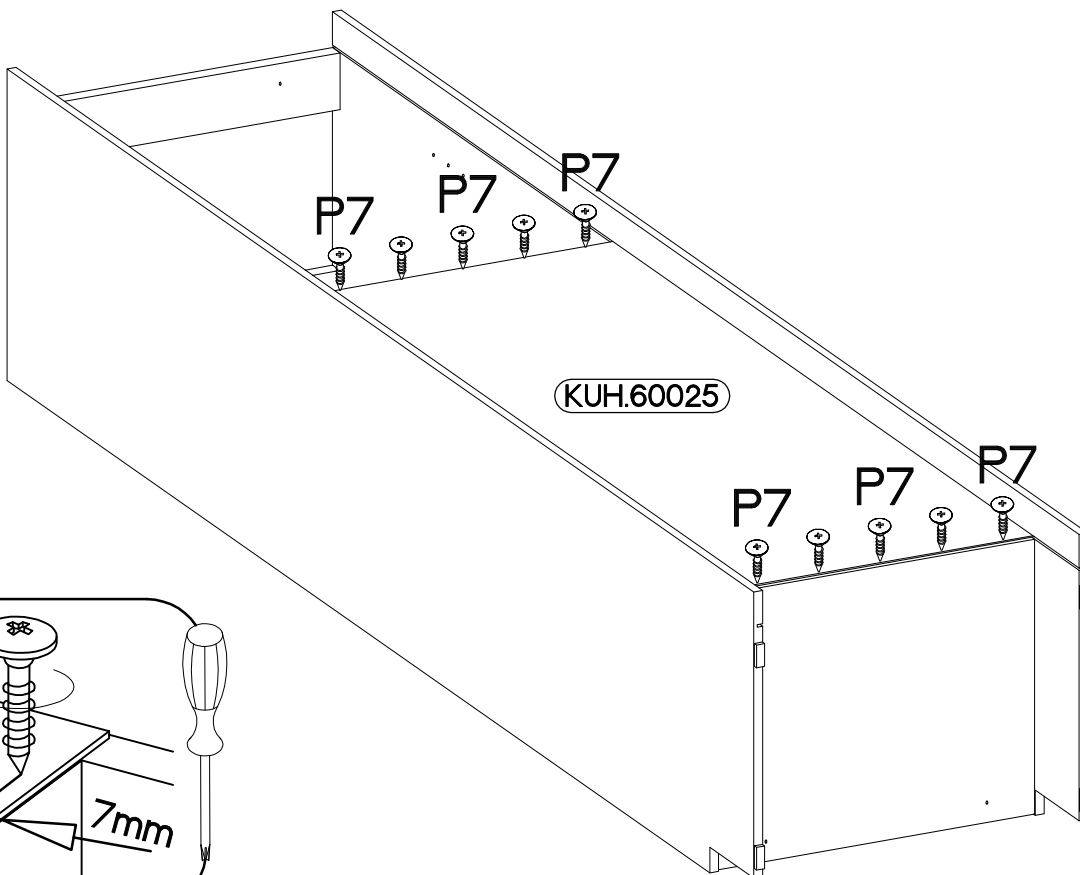
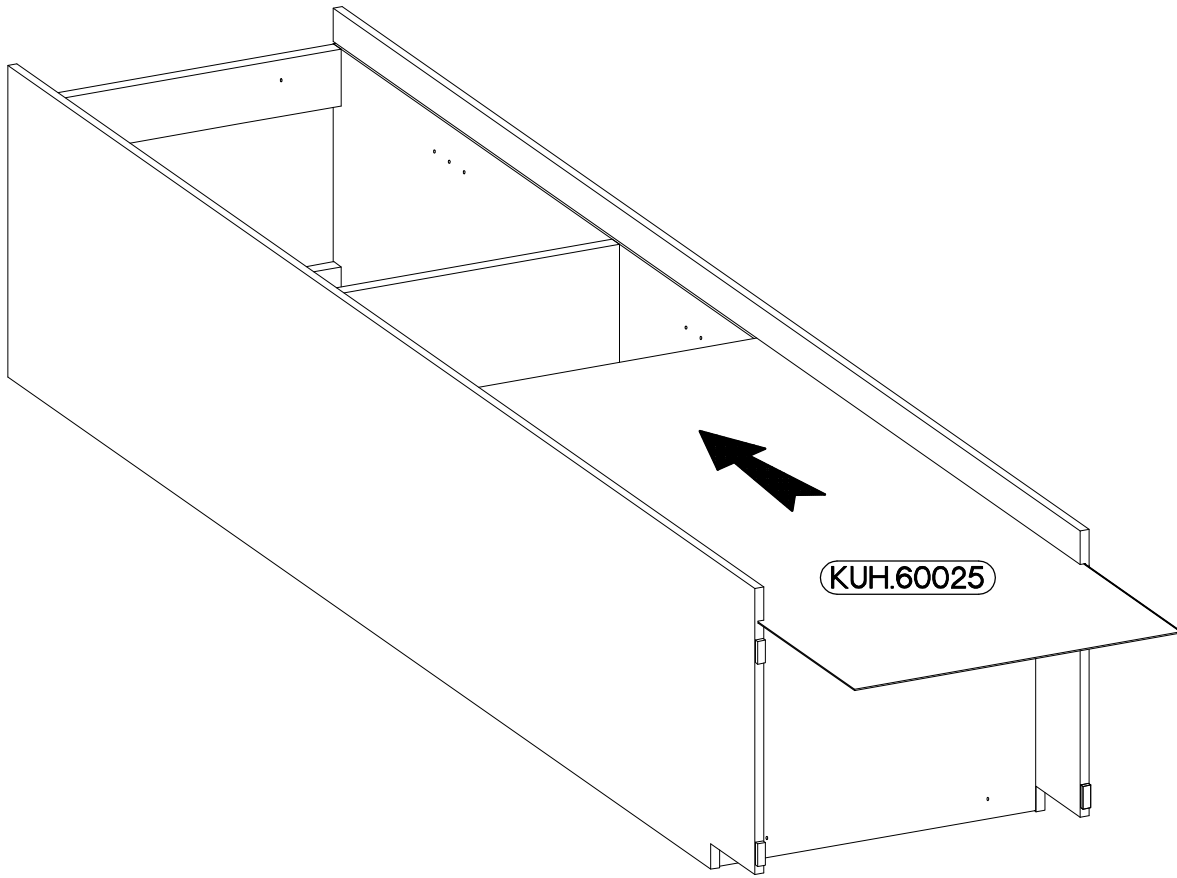
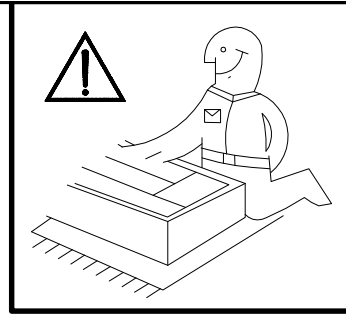
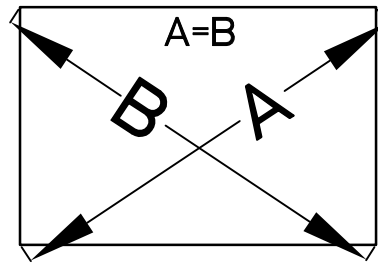

P7

8-10



5

 P4	 E9
2	2

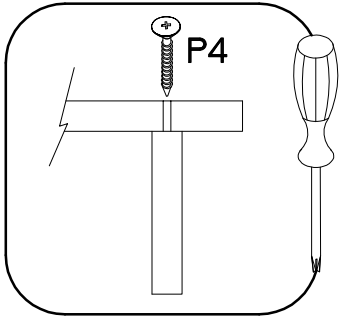
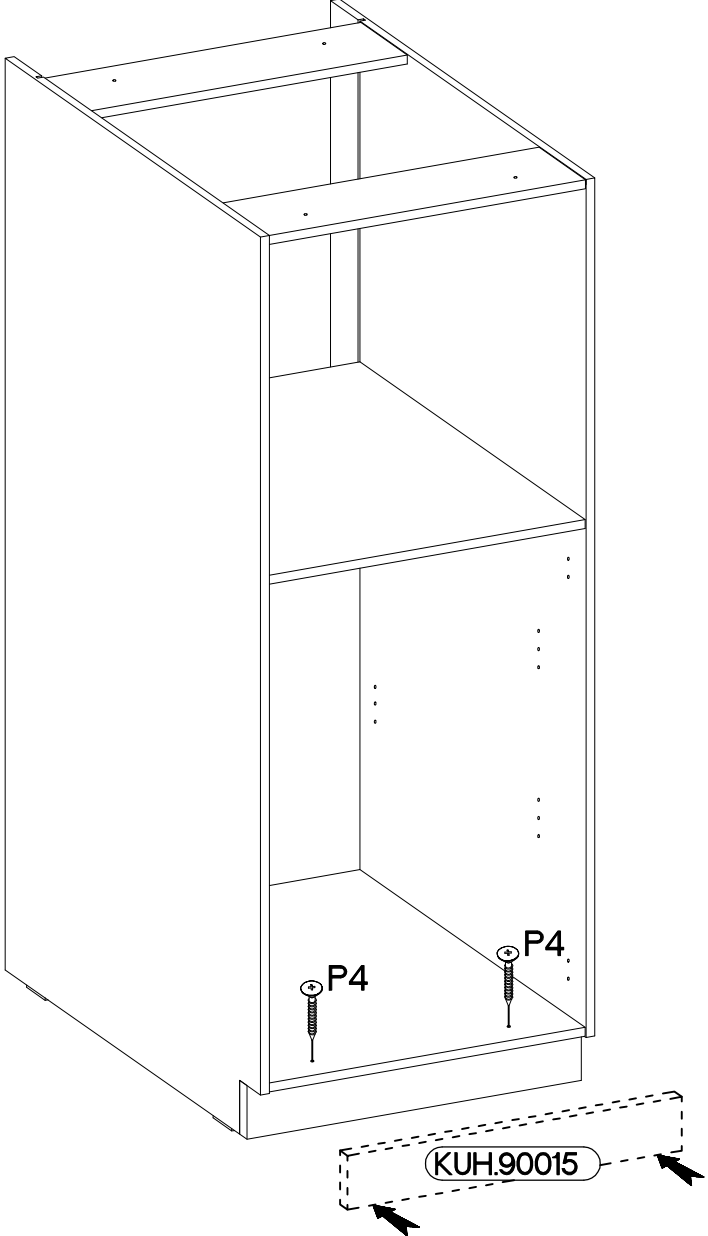

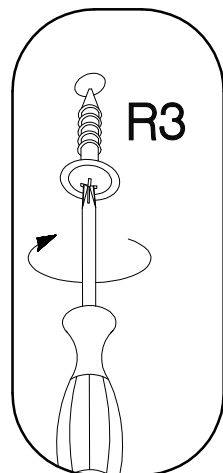
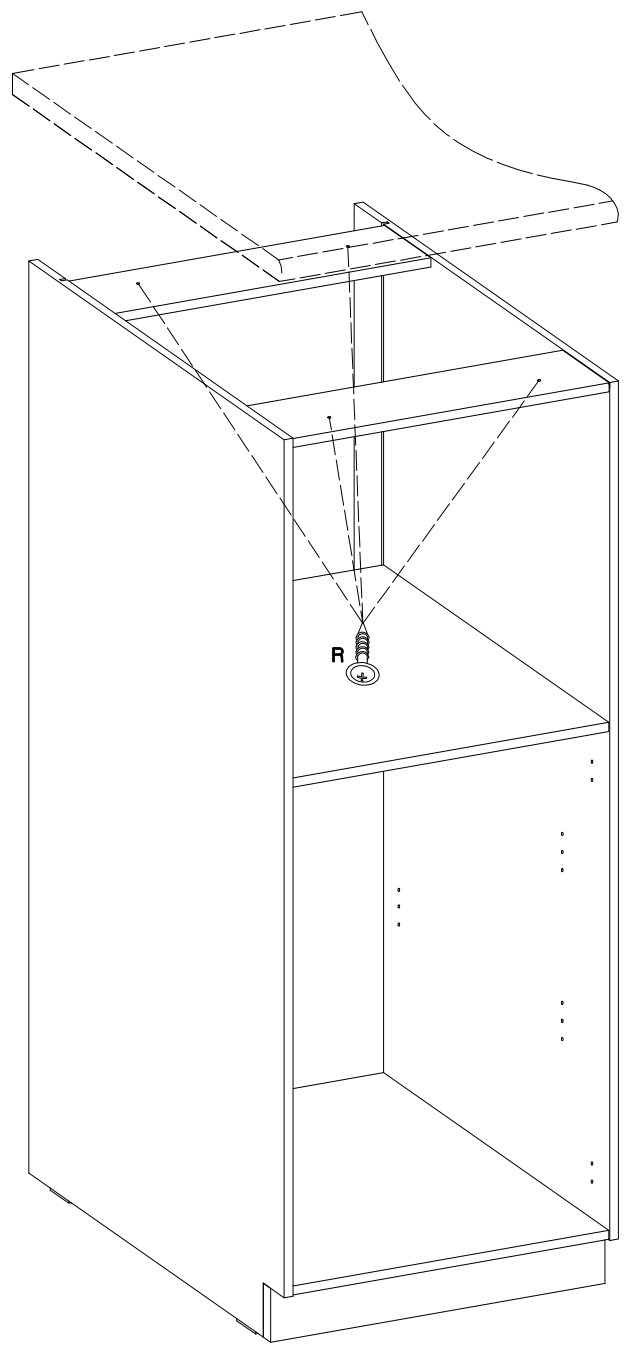

6

 R
4

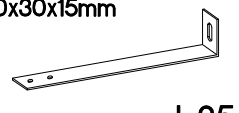

7

120x30x15mm	±3.5x13mm
	
L25	P5
1	2

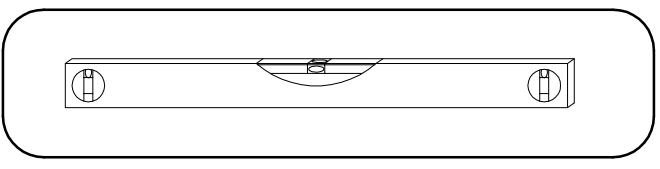
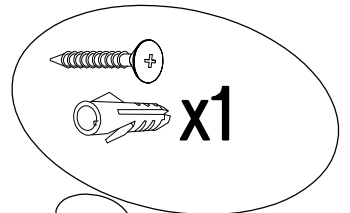
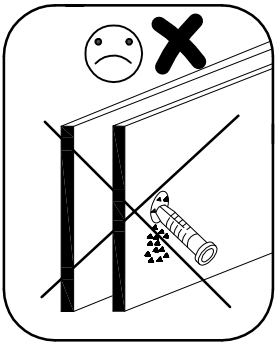
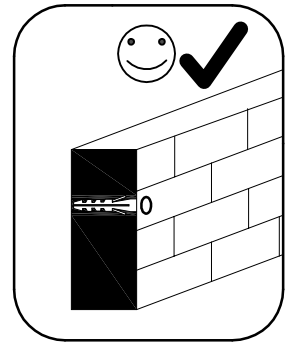
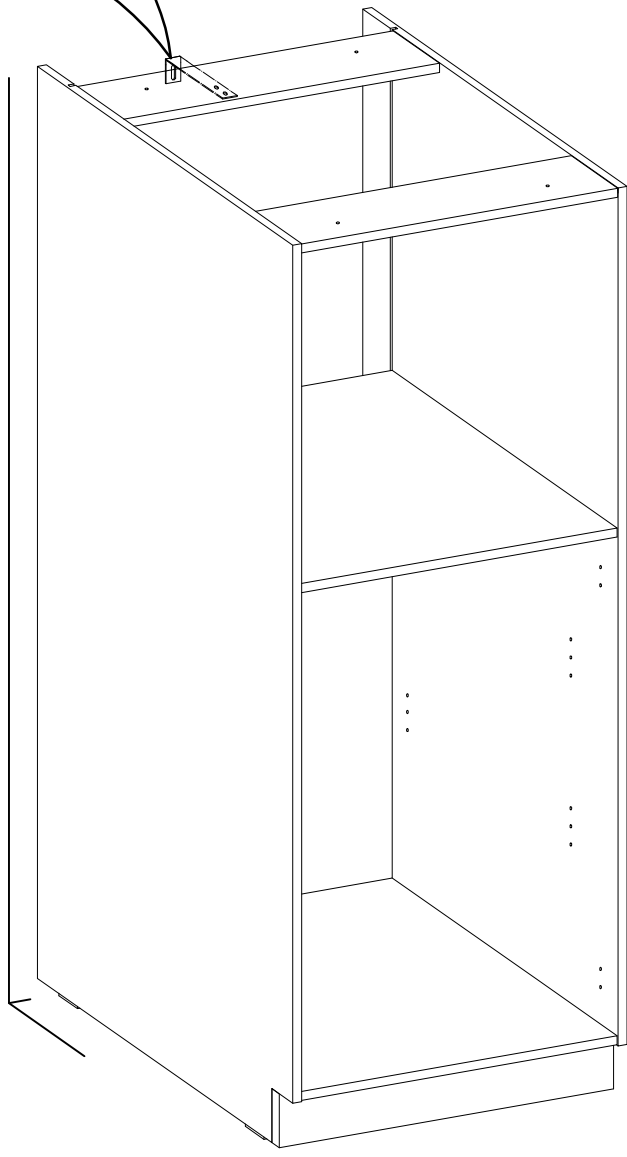
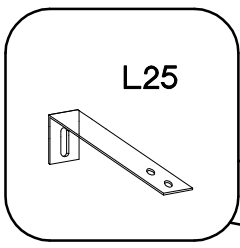
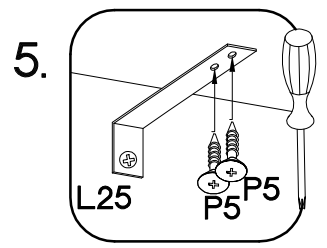
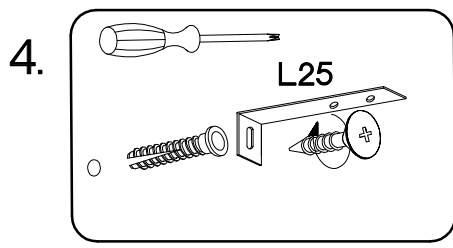
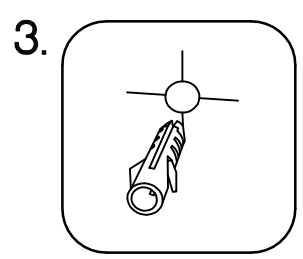
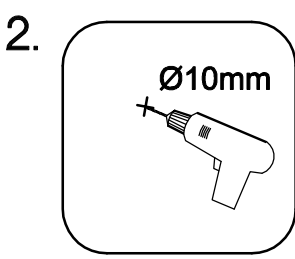
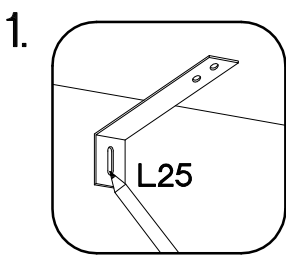

8

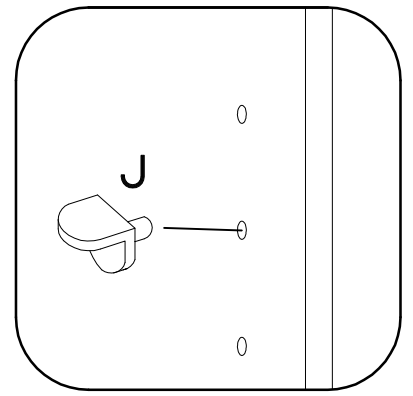
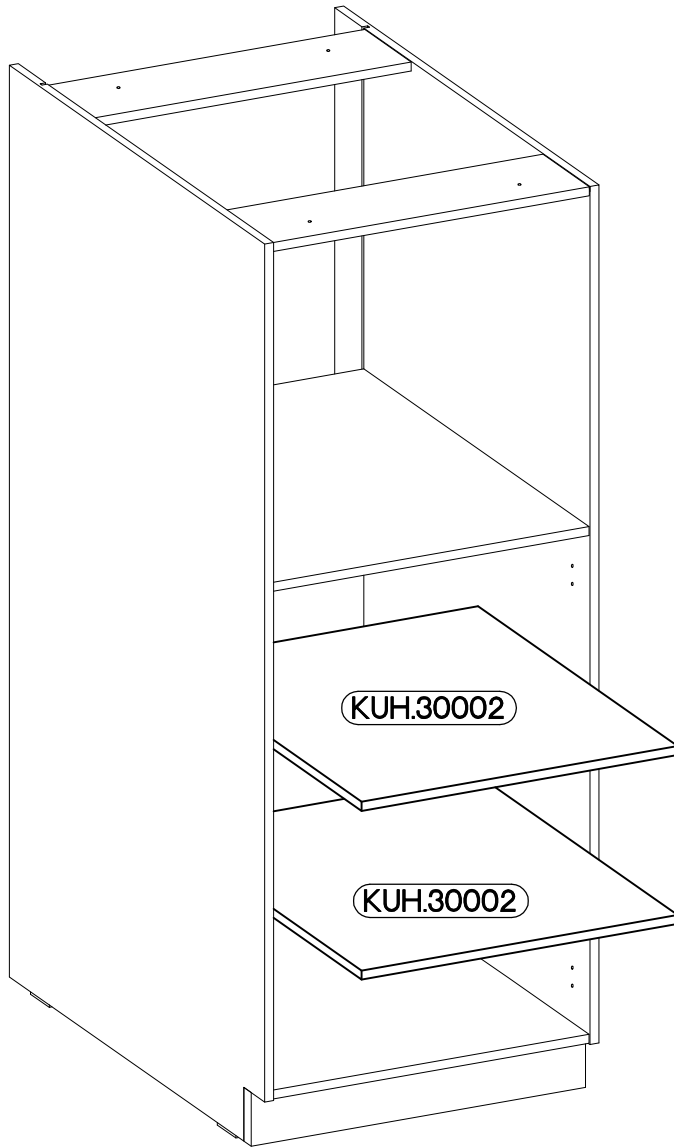
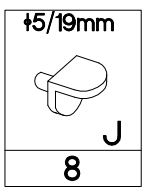

9

FRONT

