

**30 DK-162
CARGO**

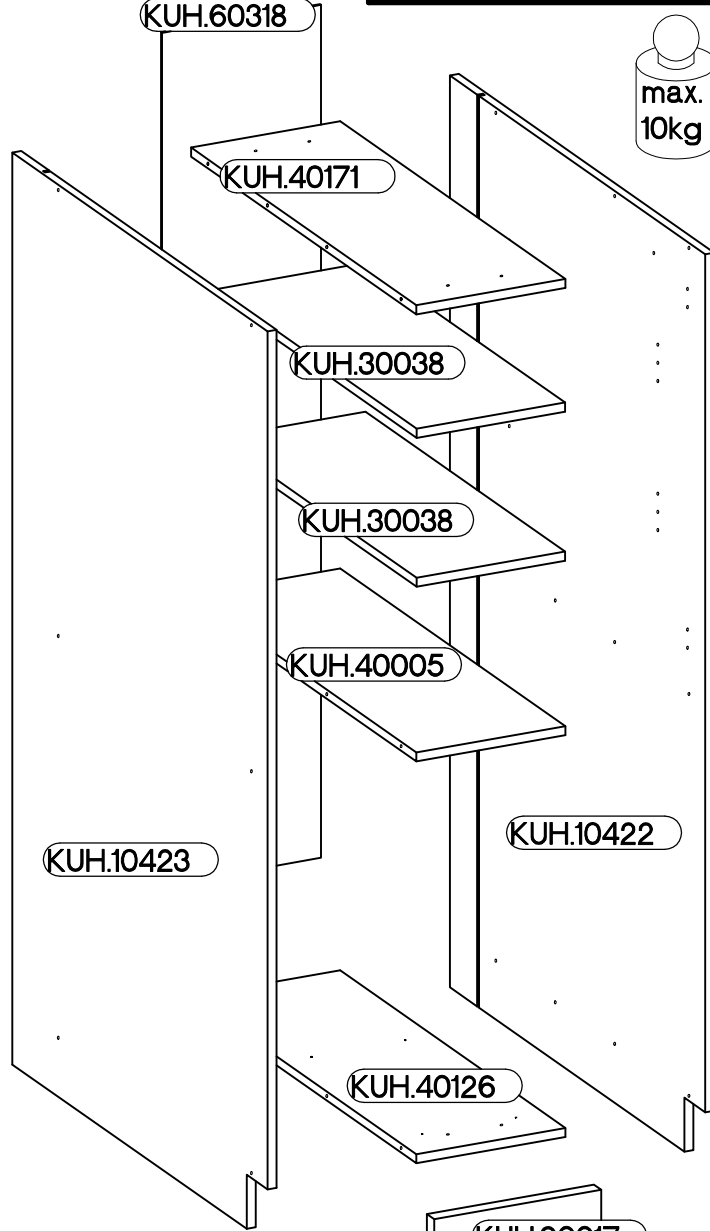

max. 10kg
KUH.30038
KUH.40005

 A 12	 B 12	 E1 12	 E9 2	 F2 4	 HG 2
 J 8	 L25 1	 O 1	 P4 2	 P5 6	 P7 8-10

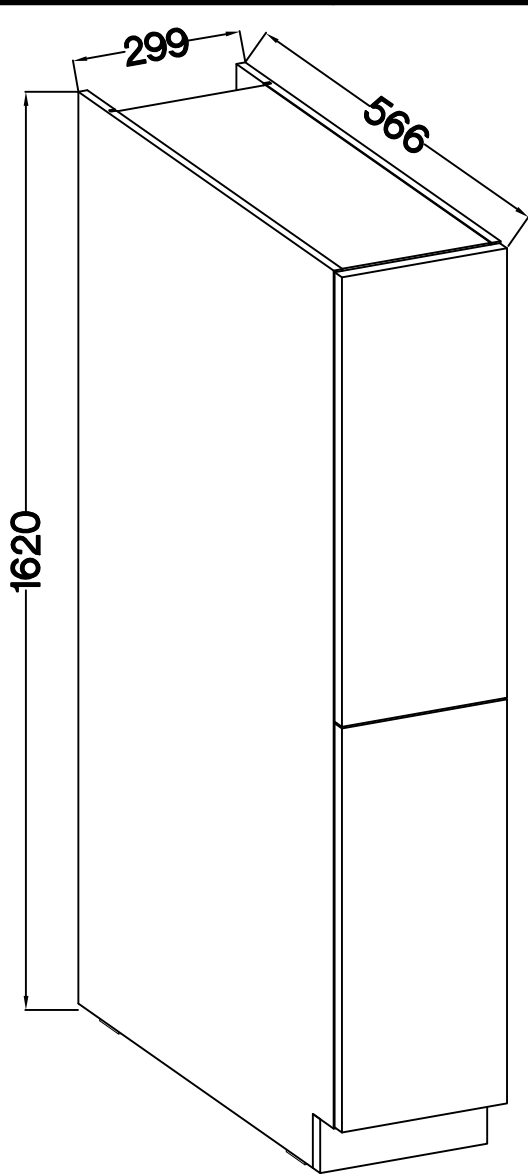
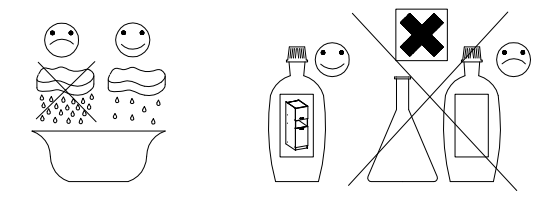
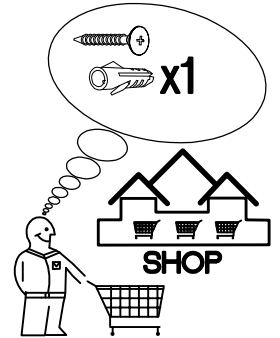

ISM-KUH-01611

1

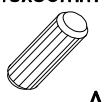
6.5x48x16	+8x30mm
	
F2	A
4	12

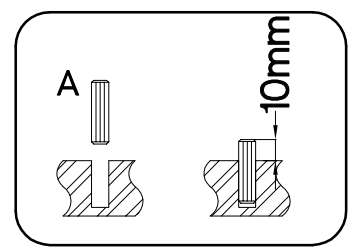
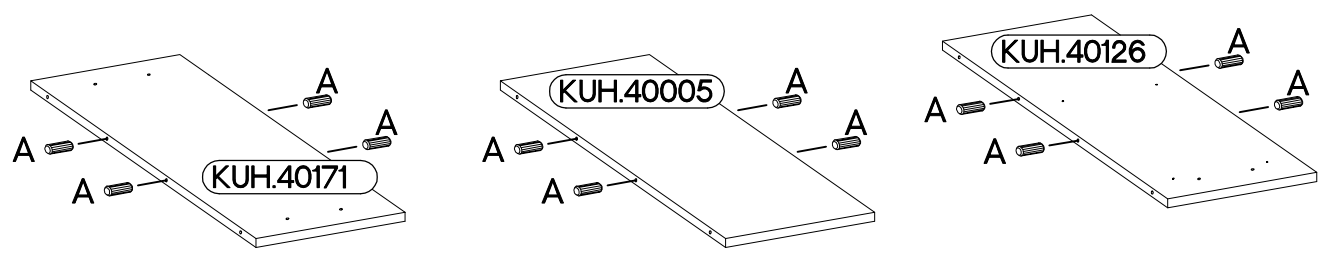
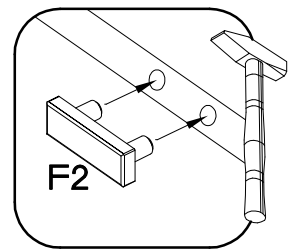
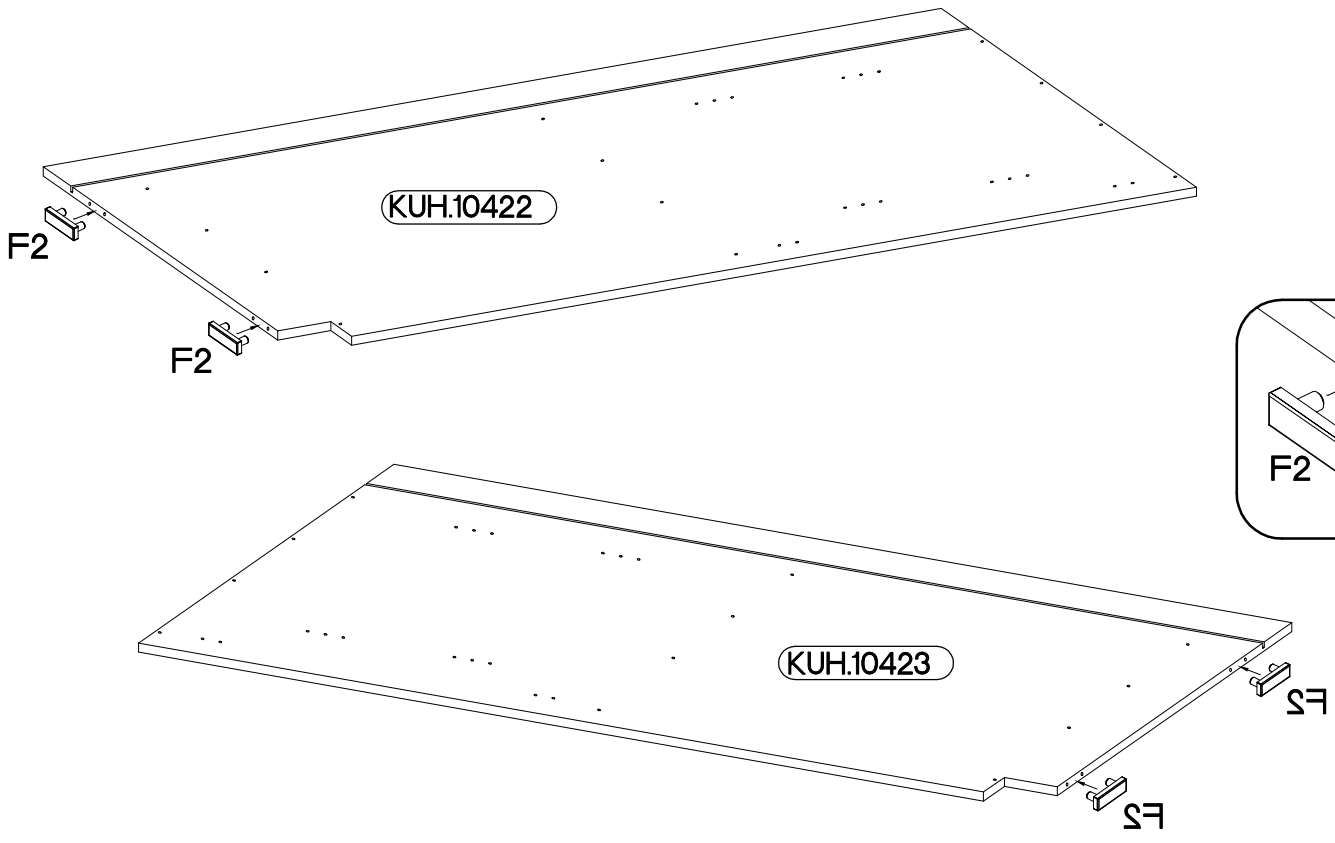
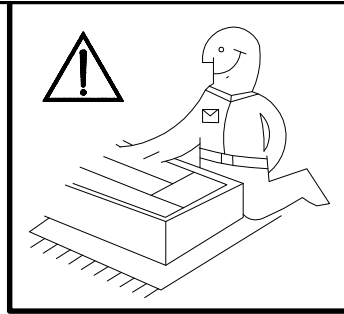

2

6,4 x 50mm

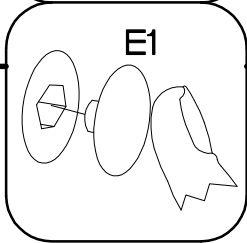
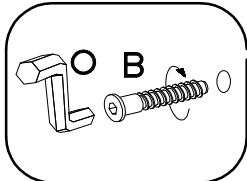
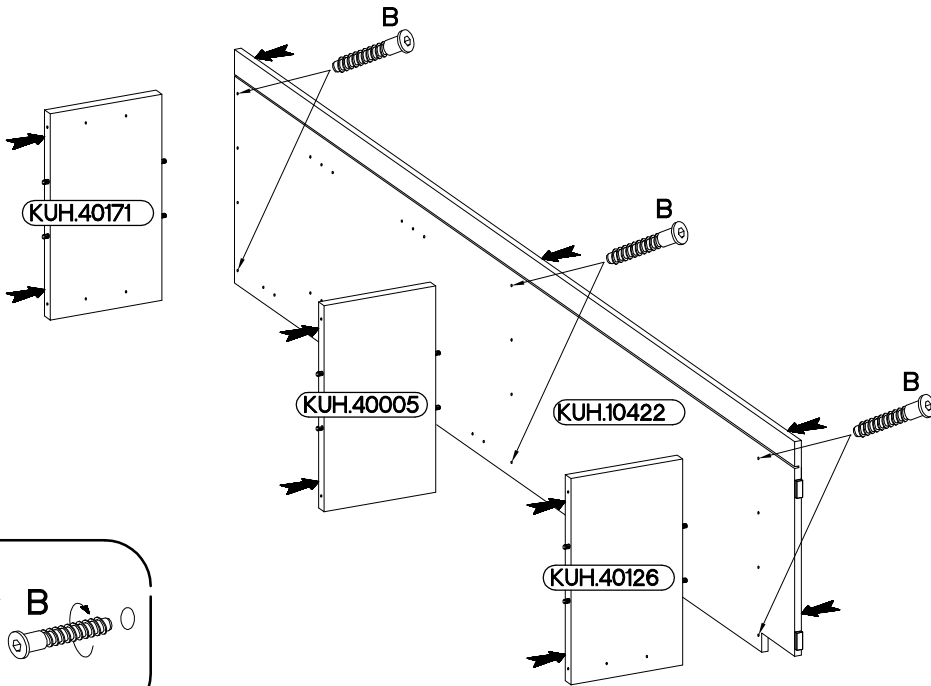
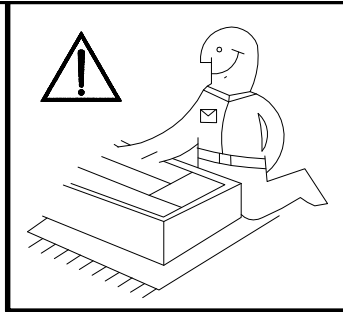
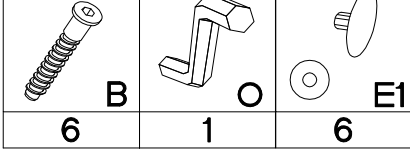

3

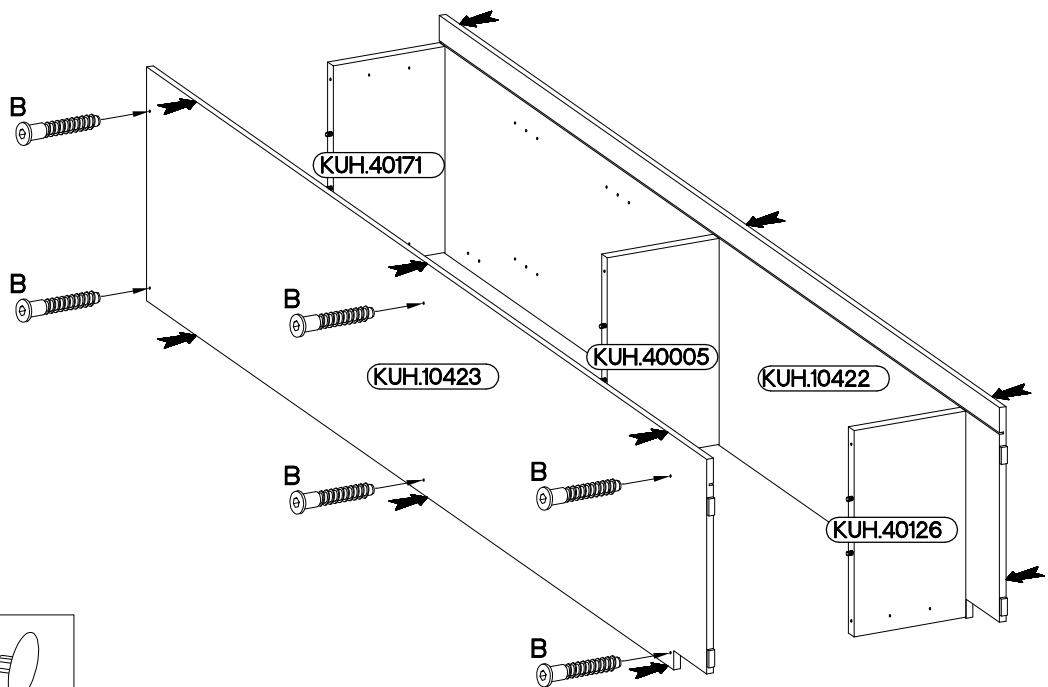

6,4 x 50mm

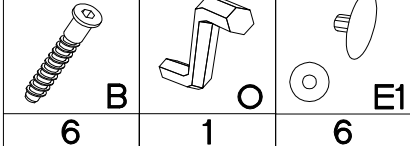

4

±3.0x20mm



P7

8-10

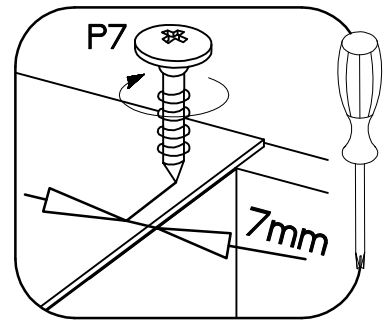
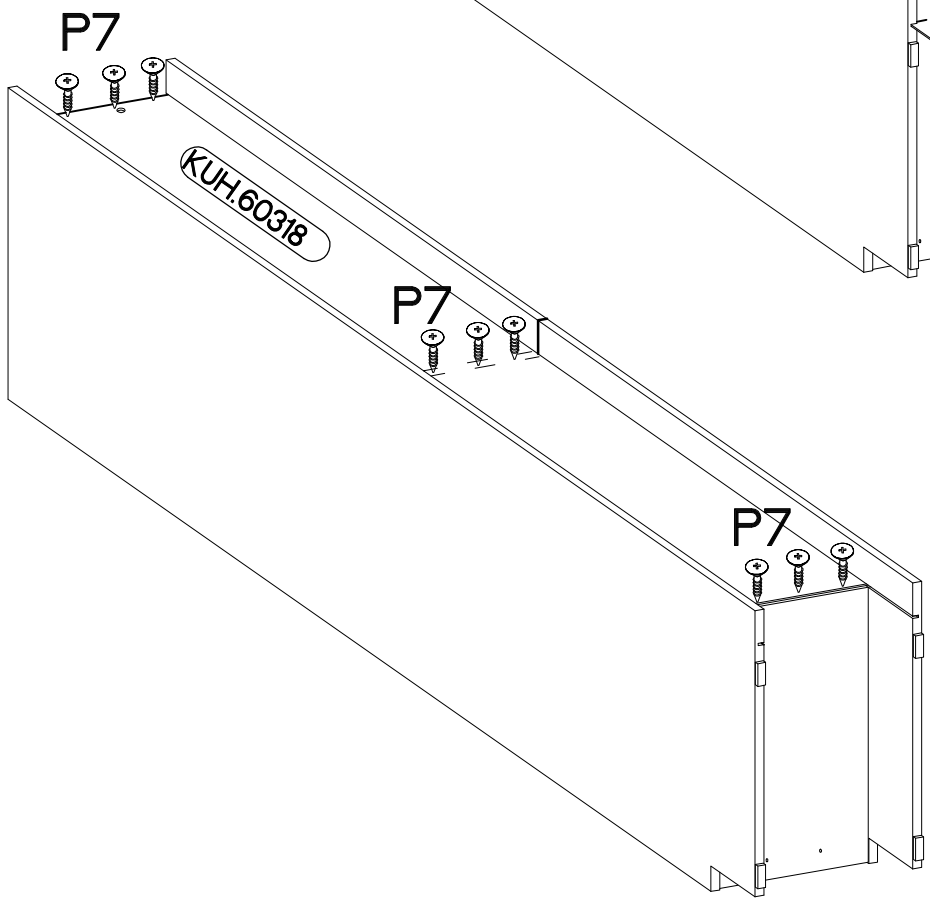
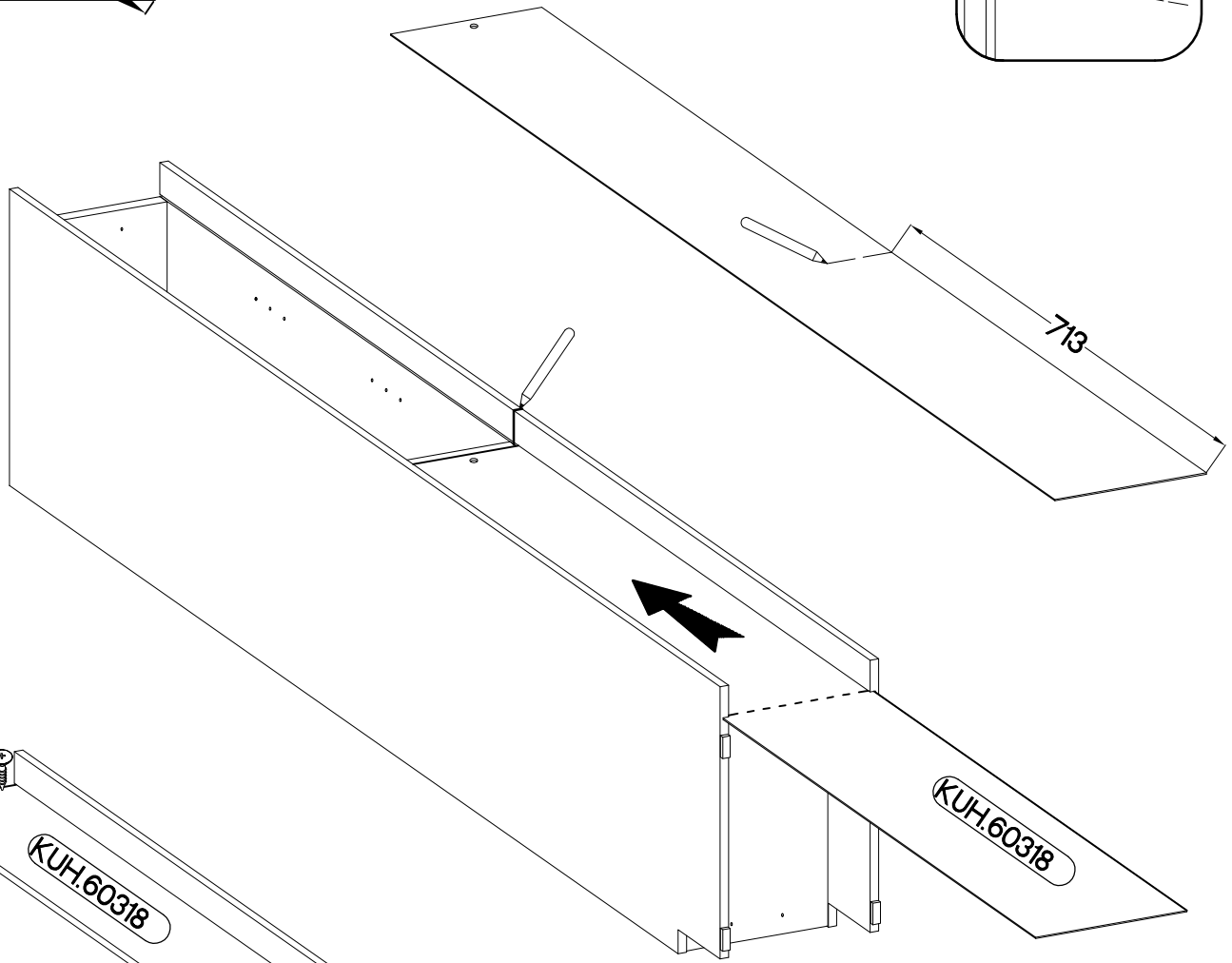
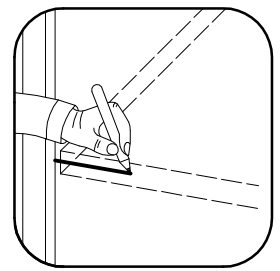
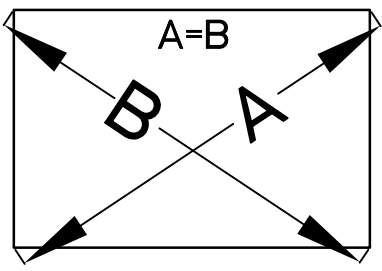
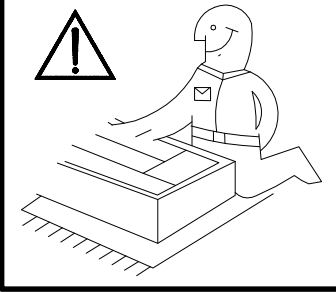
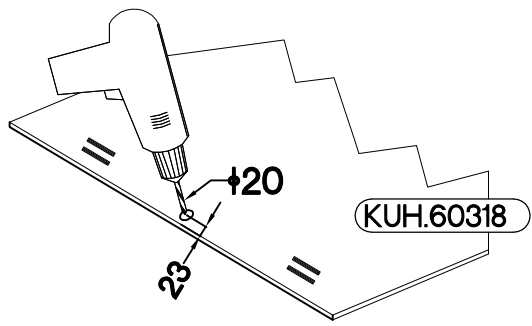

5

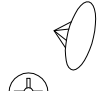

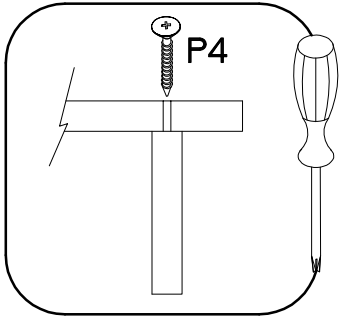
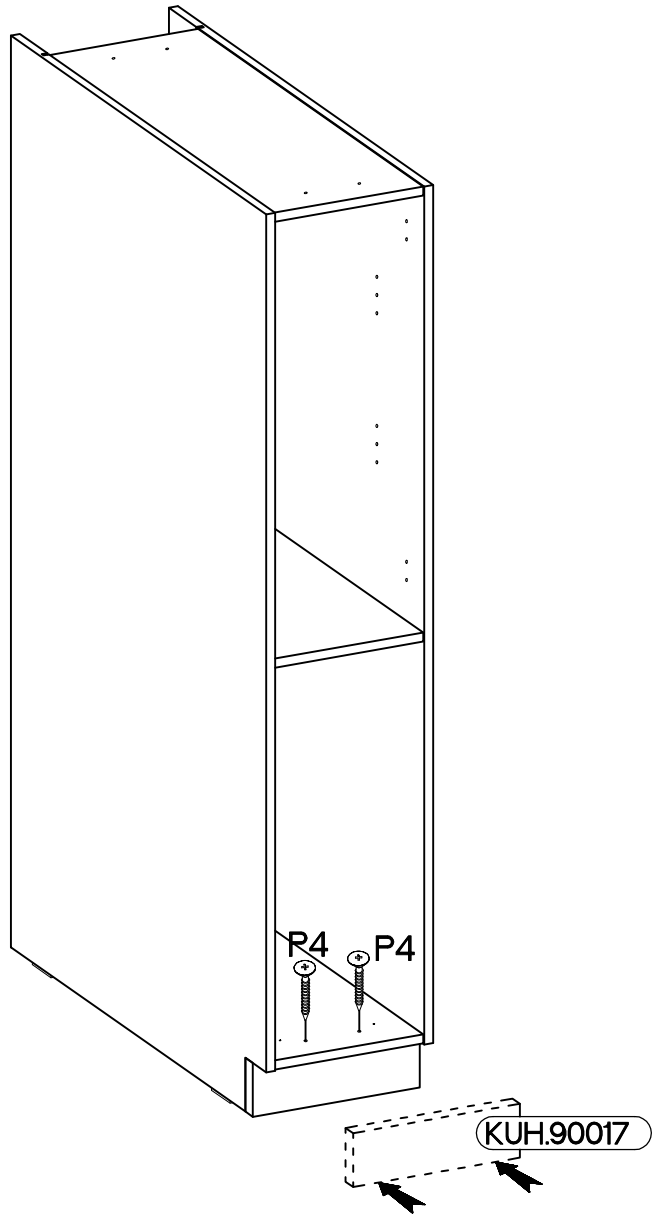
 †4.0x45mm P4	 E9
2	2

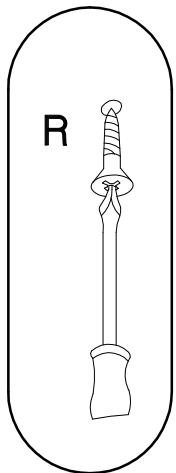
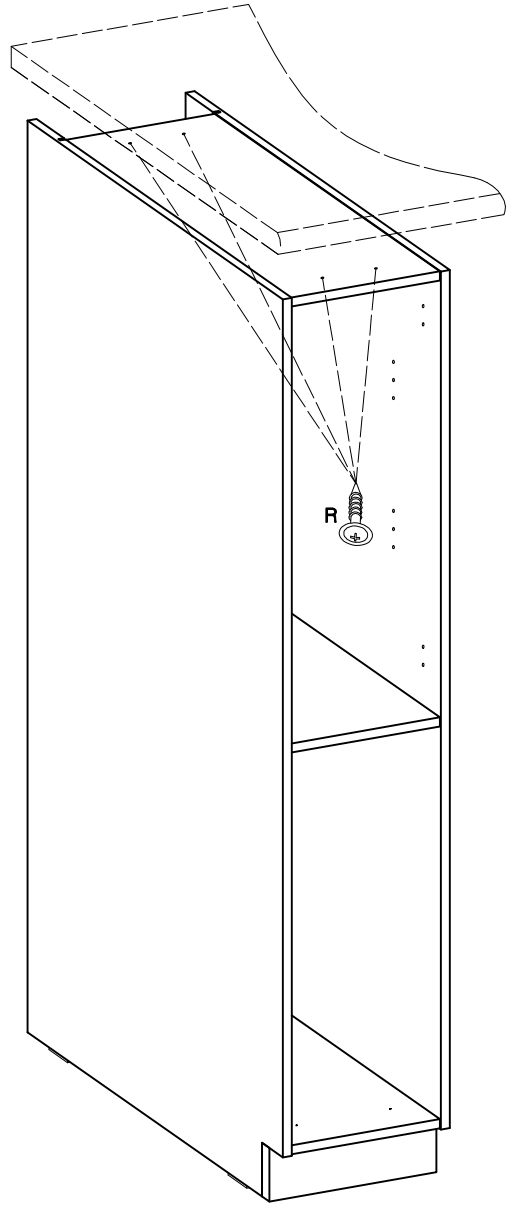

6

 †4.0x25mm R
4

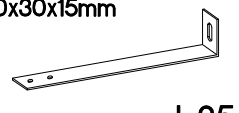

120x30x15mm	13.5x13mm
	
L25	P5
1	2

1.

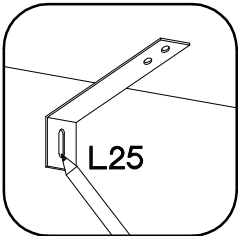

2.

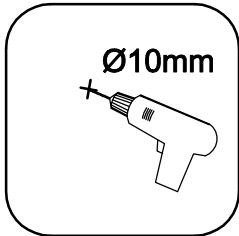

3.

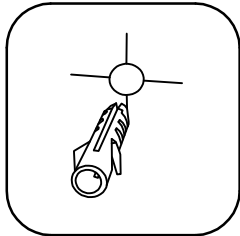

4.

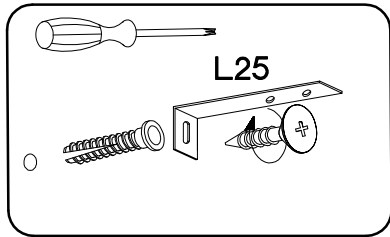

5.

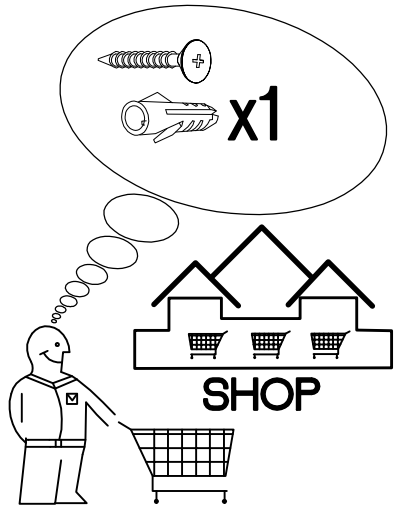
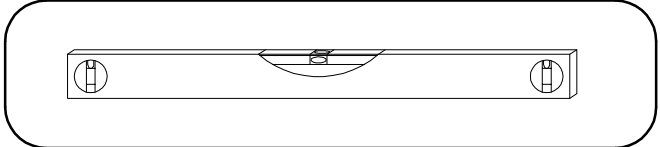
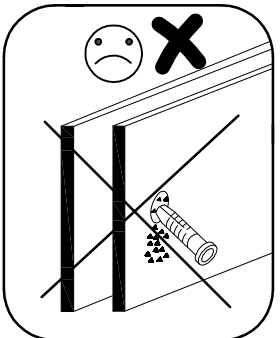
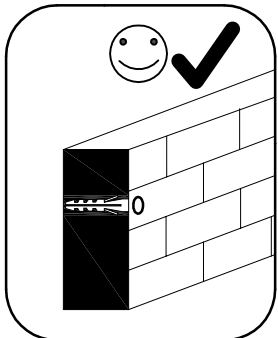
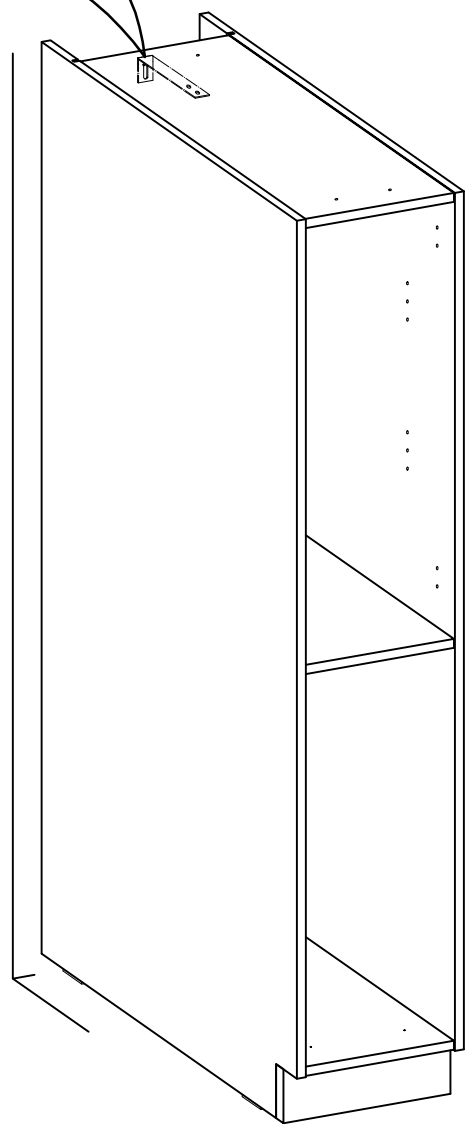
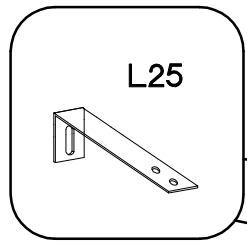
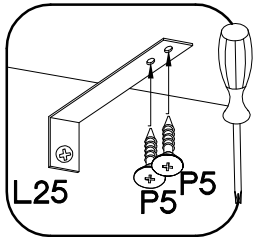

8

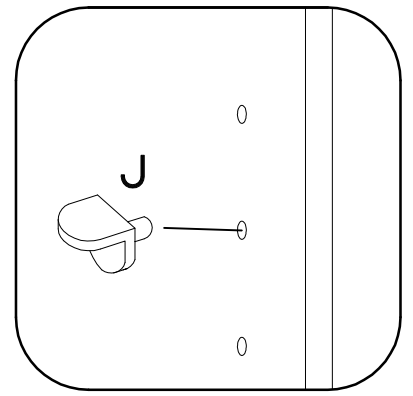
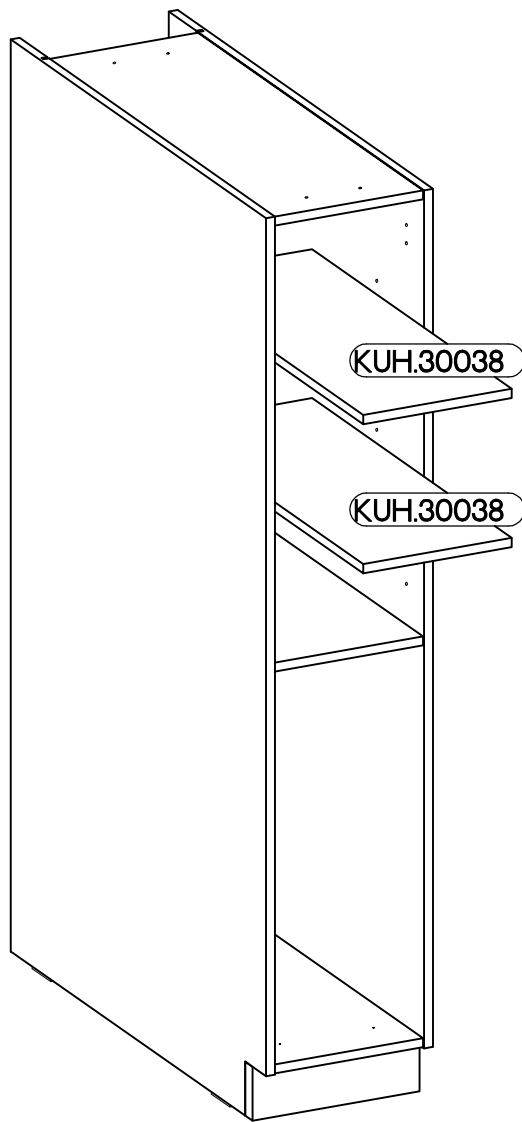
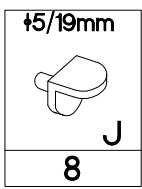

9

