

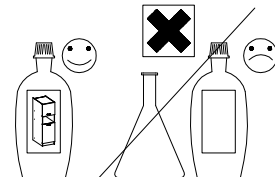

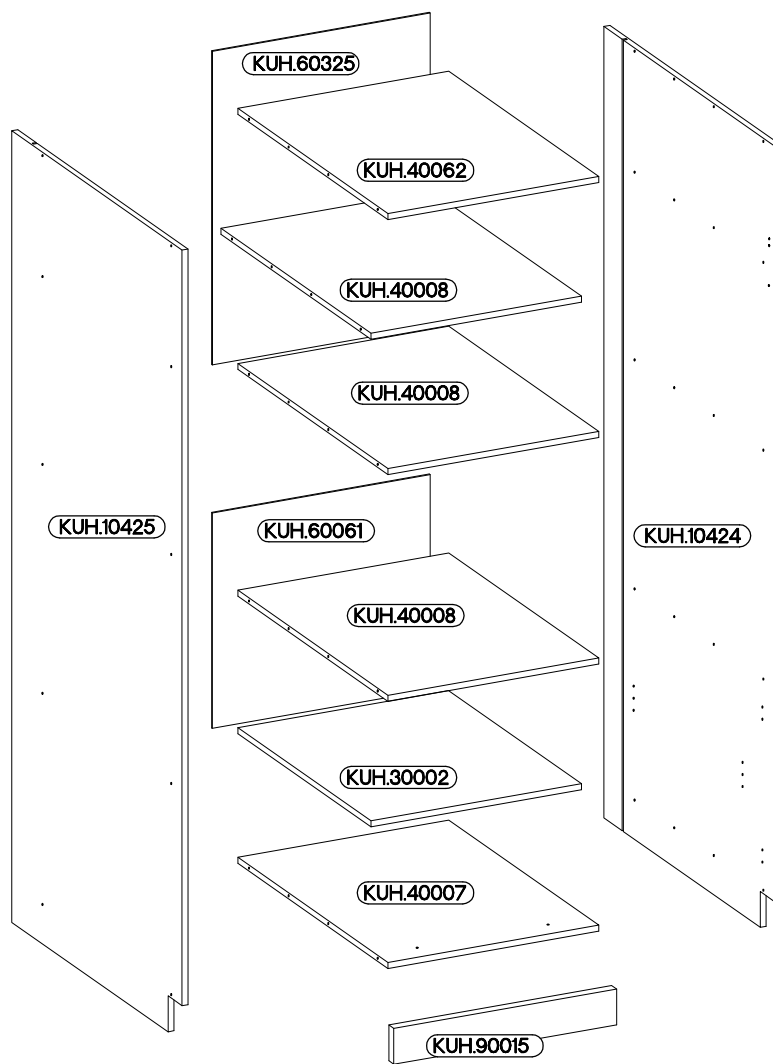

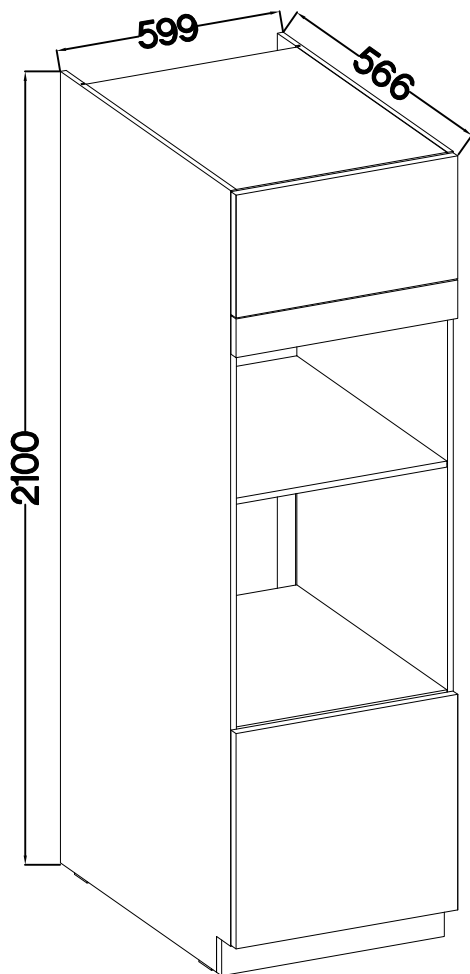









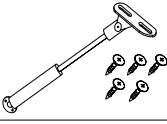

60 DPM-2100 2F



max. 10kg
 KUH.30002
 KUH.40007
 KUH.40008



 A 20	 B 20	 F2 4	 HG 4	 J 4	 J5 2	 K24 2
 E1 20	 E9 2	 L25 1	 O 1	 P1 4	 P4 2	 P5 10
		 P7 15-20	 T3 2			



ISM-KUH-01639

1

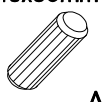
6.5x48x16	+8x30mm
 F2	 A
4	20

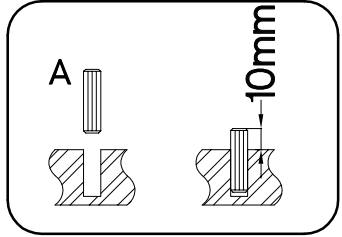
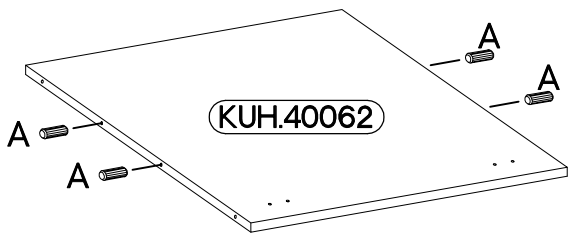
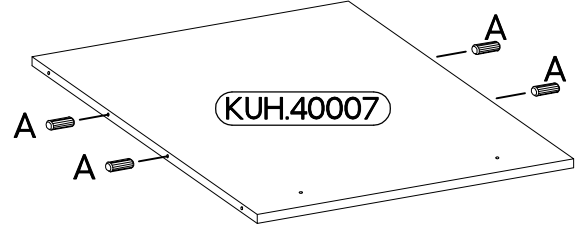
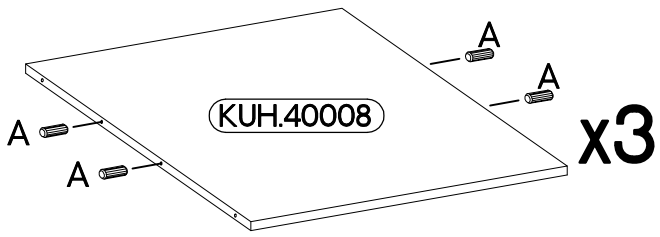
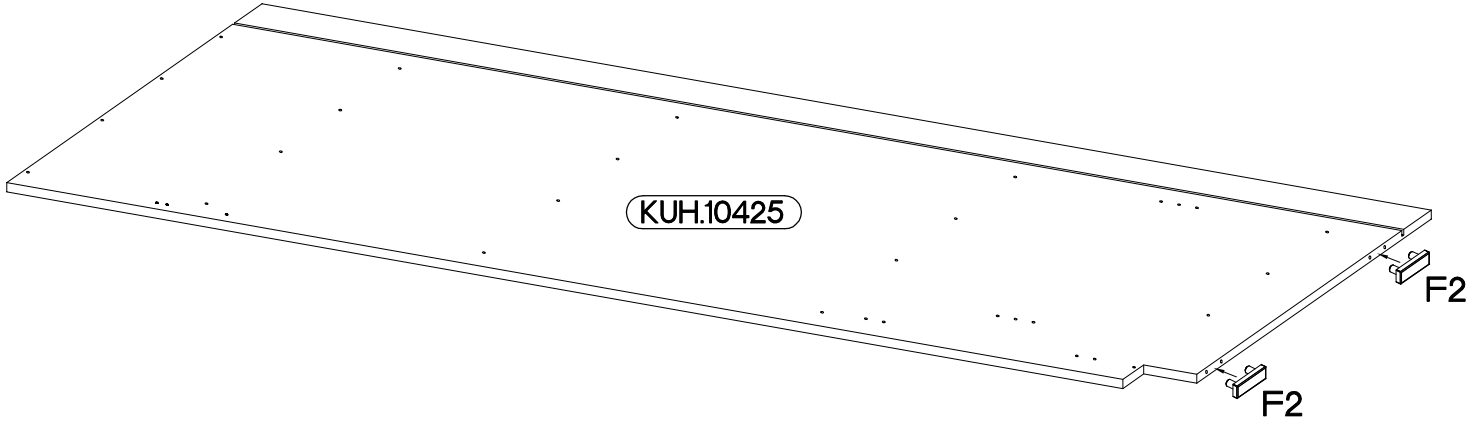
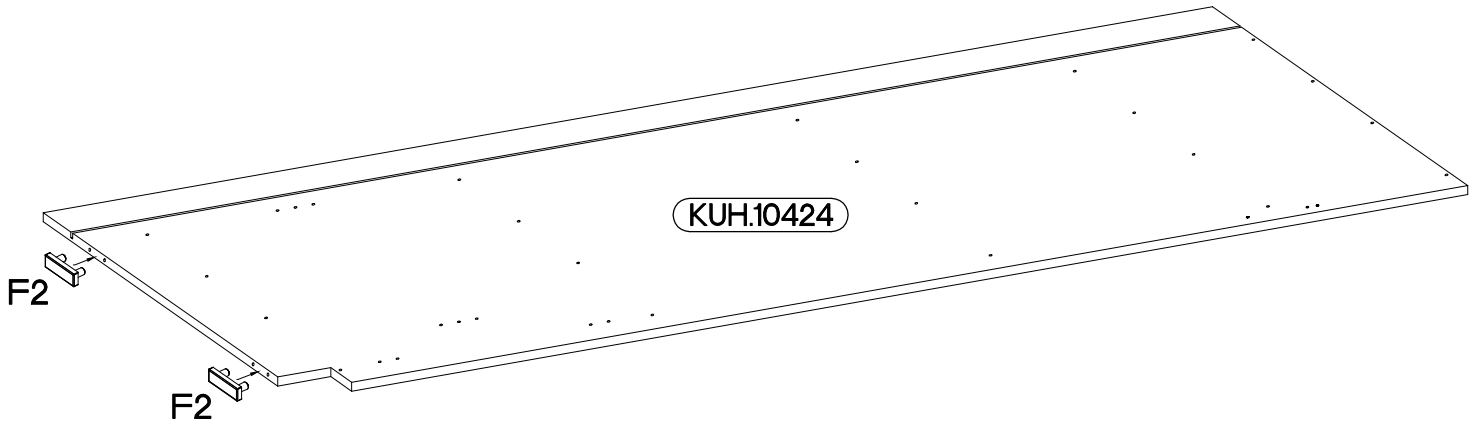
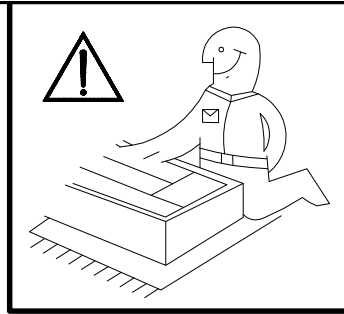
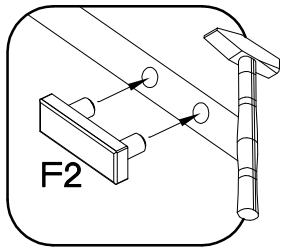

2

6,4 x 50mm

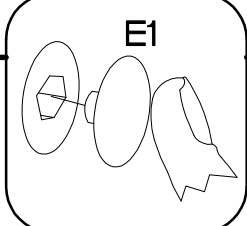
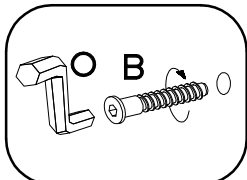
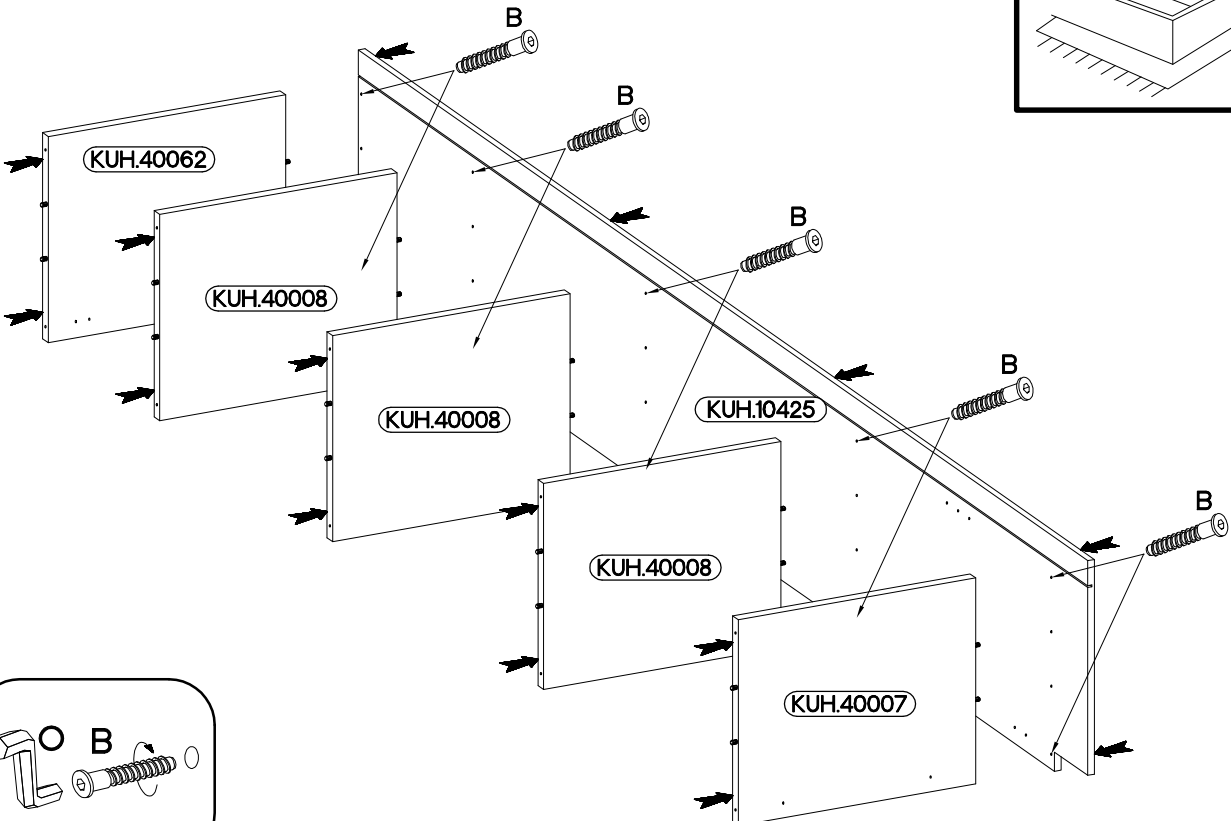
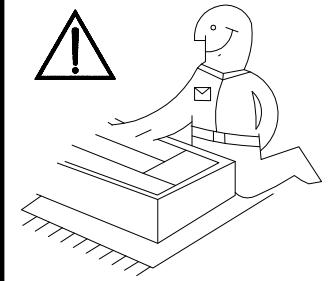
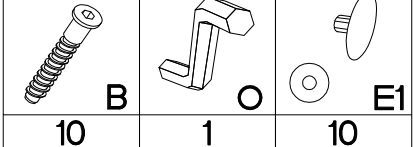

3

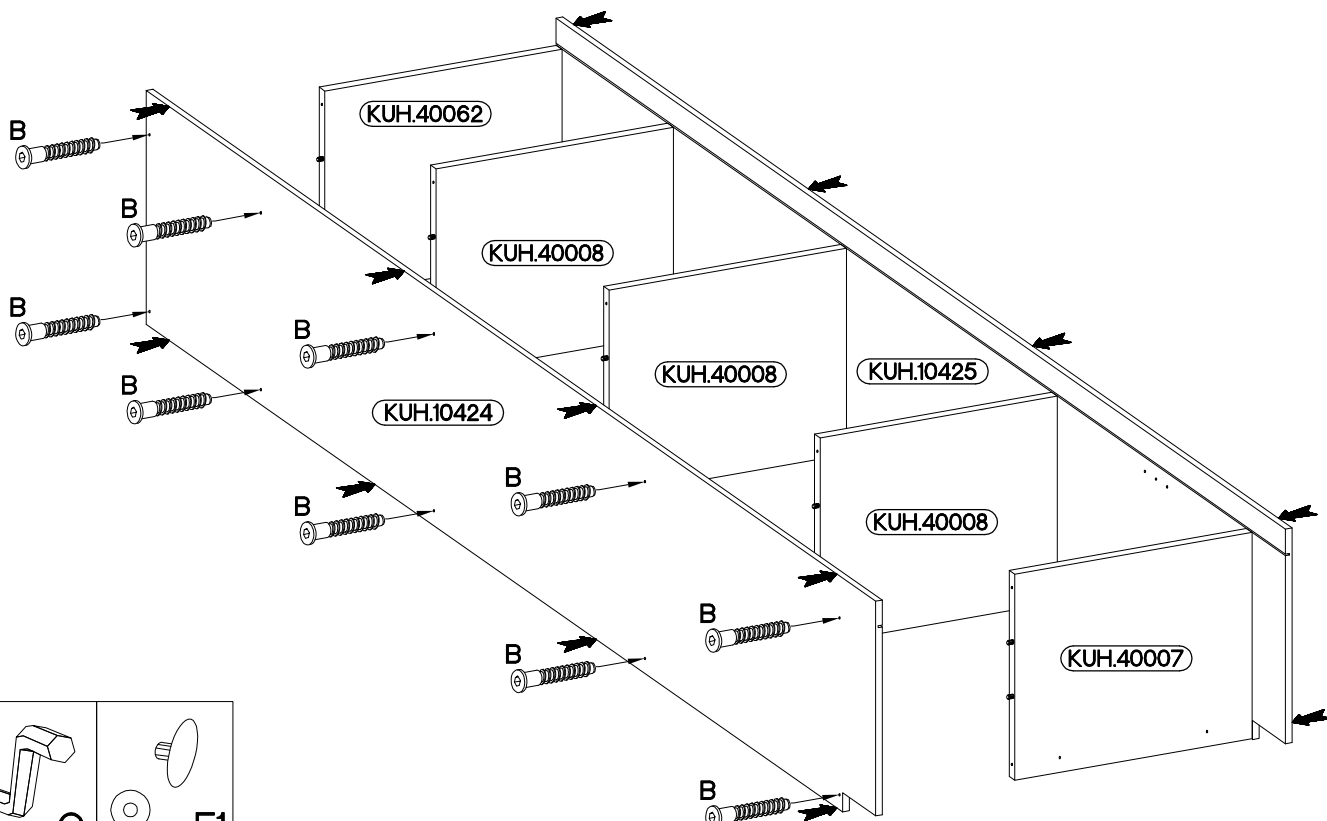

6,4 x 50mm

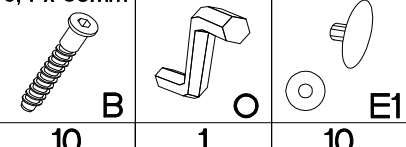

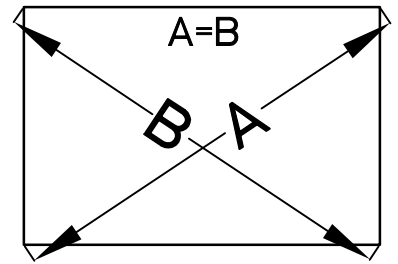
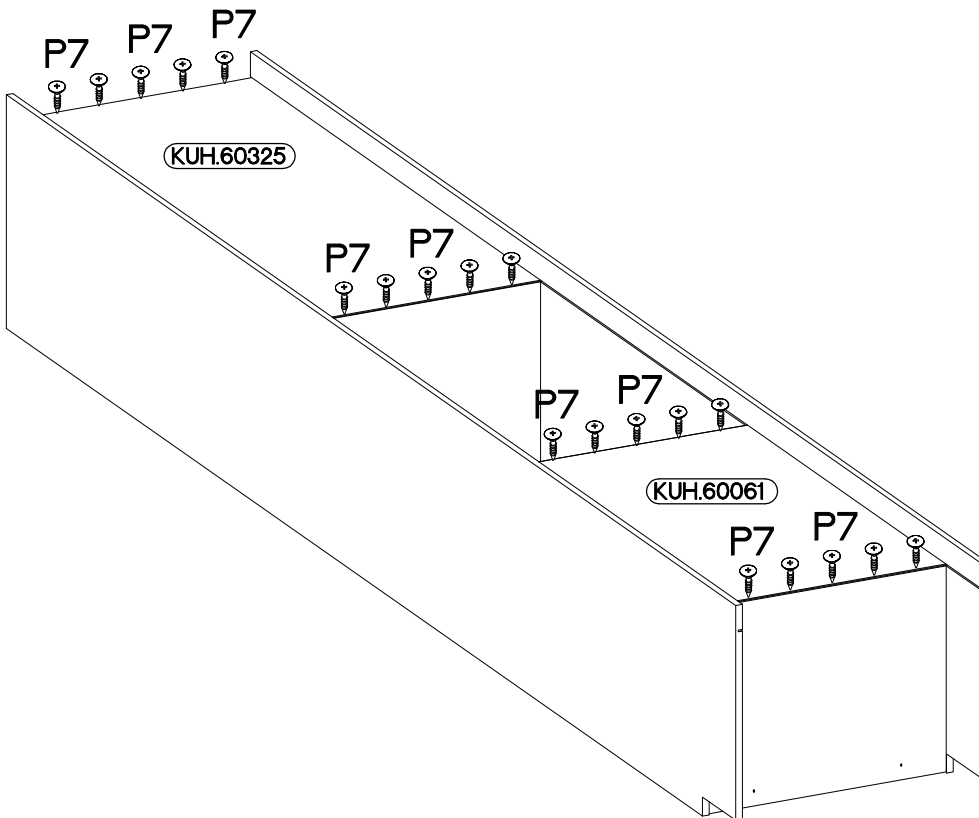
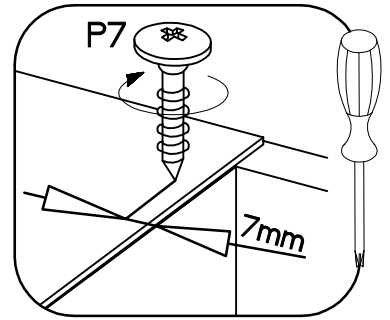
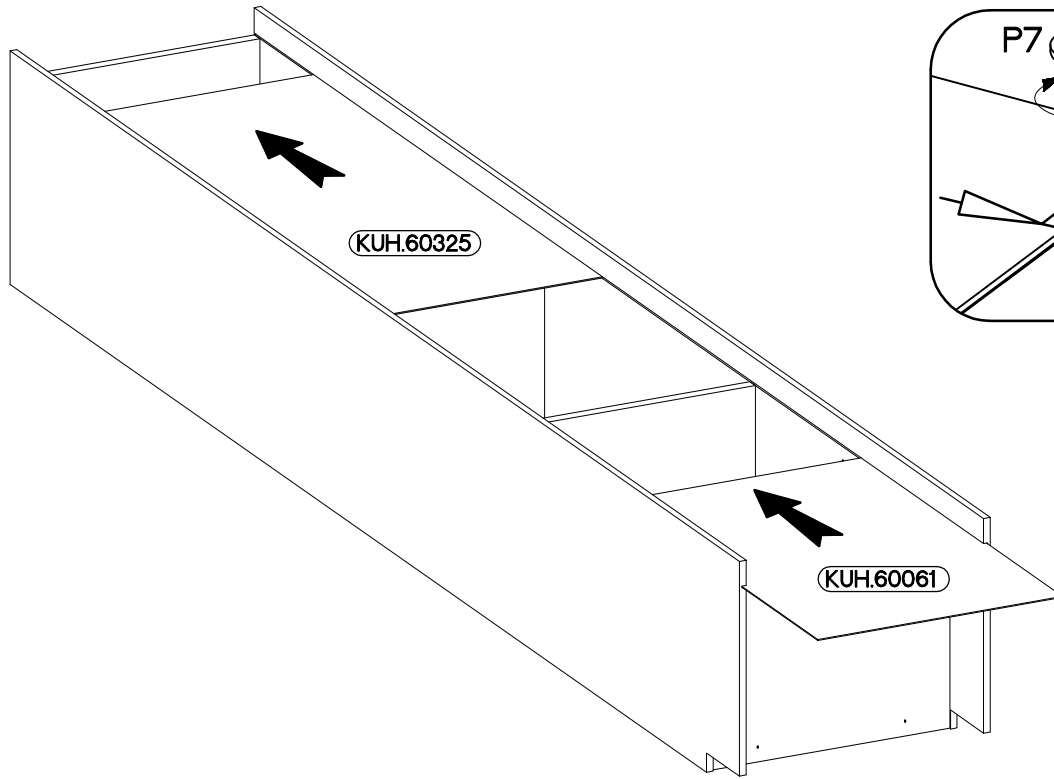
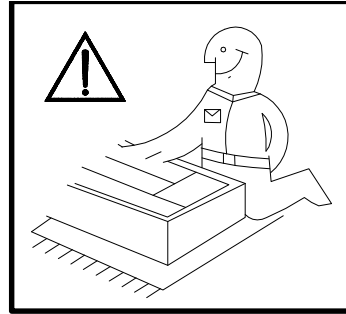

4

±3.0x20mm
P7
15-20

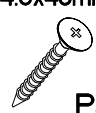

5

$\pm 4.0 \times 45 \text{mm}$  P4 2	 E9 2
--	---

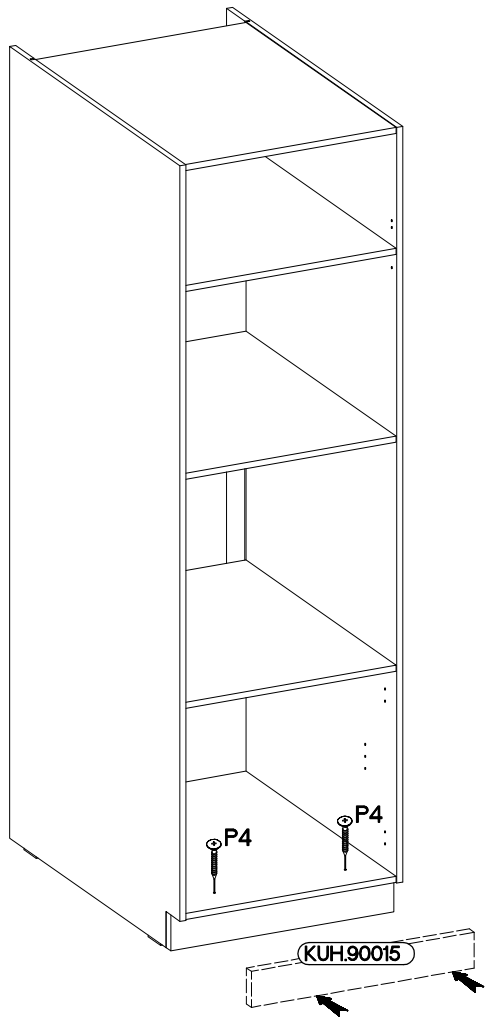

6

$\pm 5/19 \text{mm}$  J 4

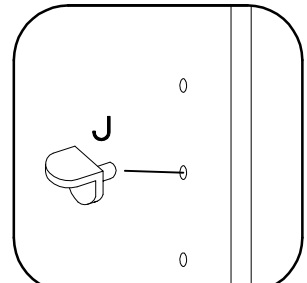
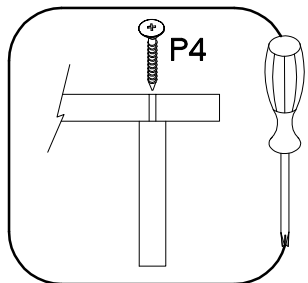
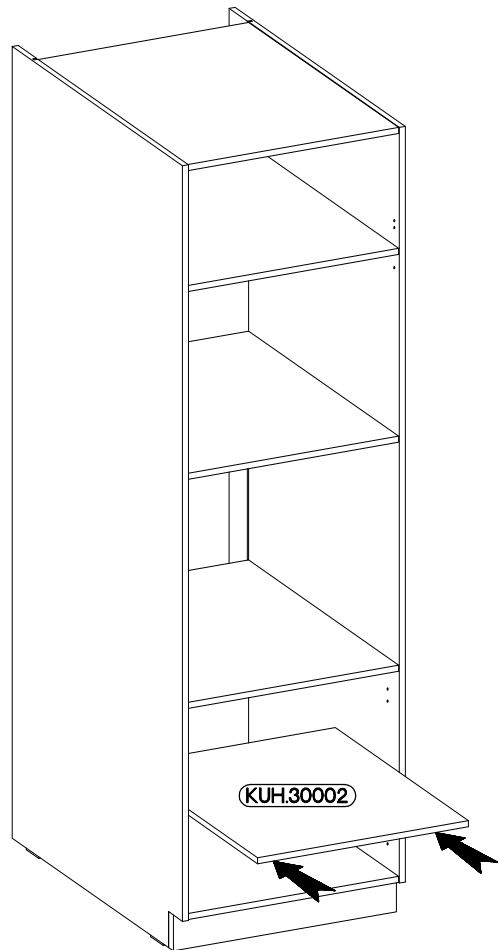

7

120x30x15mm

±3.5x13mm

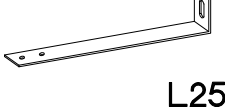

L25

P5

1

2

1.

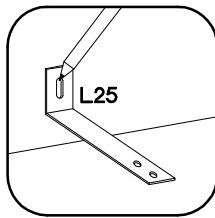

2.

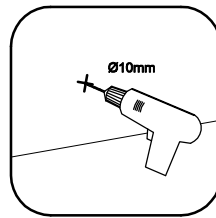

3.

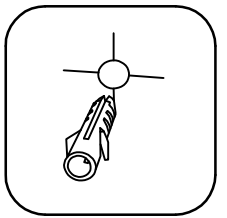

4.

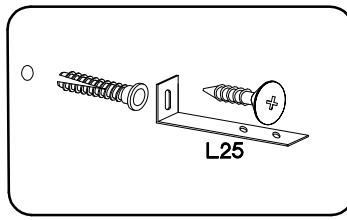

5.

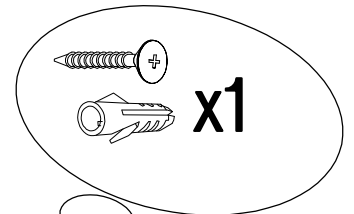
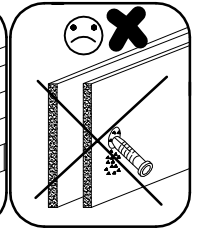
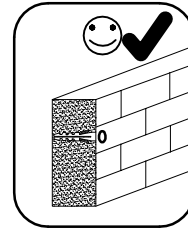
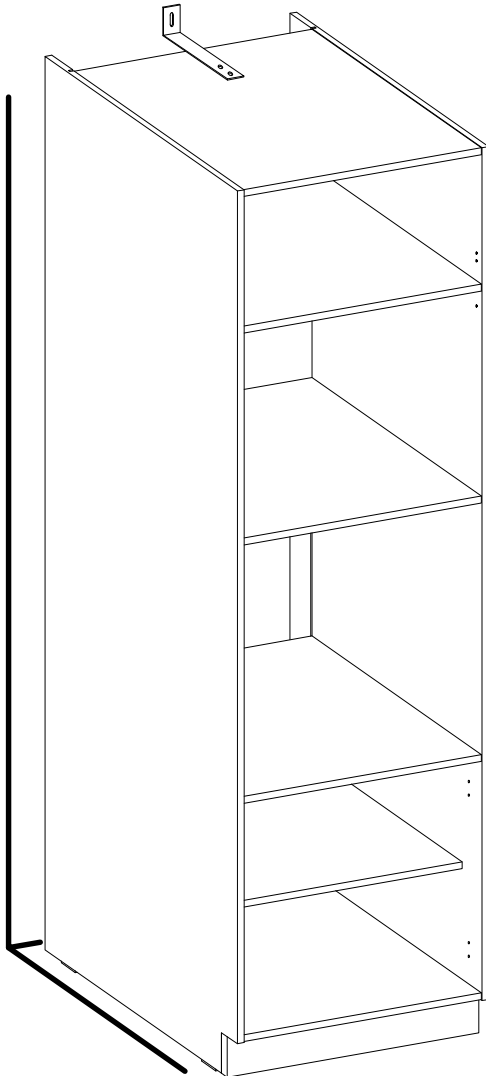
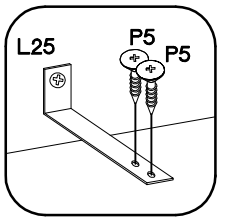

8

FRONT

