

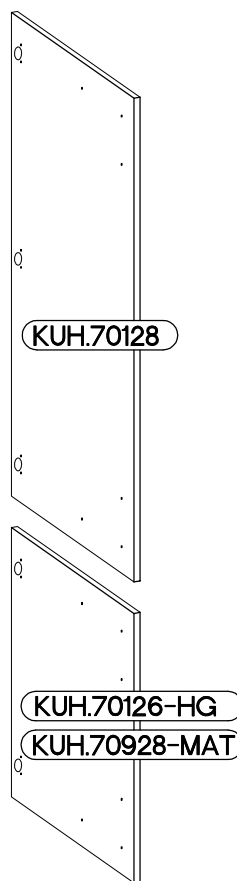

40 DK-2100 2F
FRONT

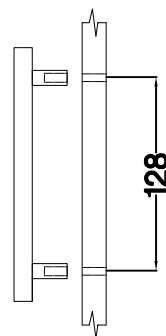
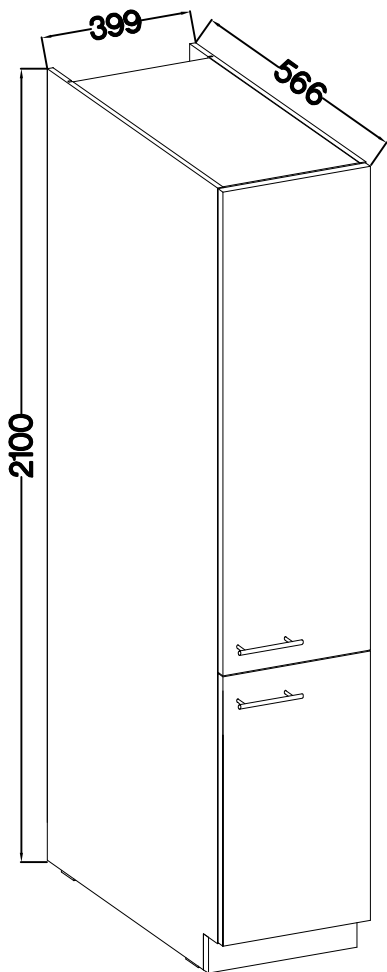

M4x22mm	L=128mm
	
U	S
4	2

ISM-KUH-01638





LEFT

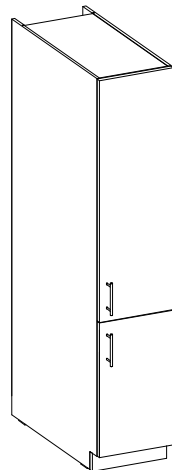
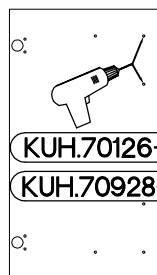
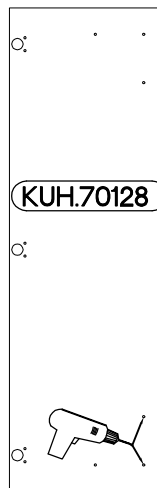
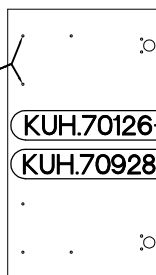
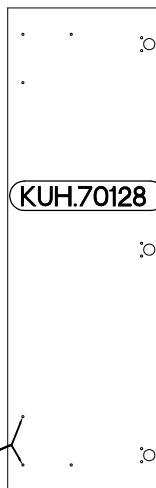
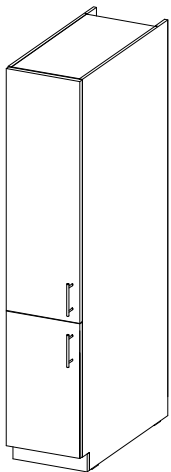
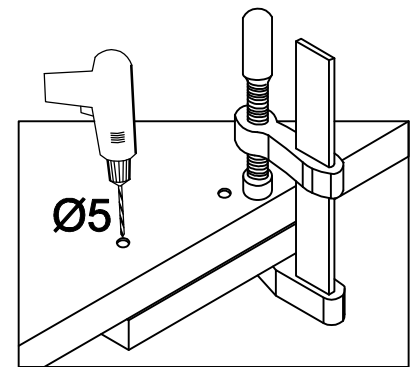
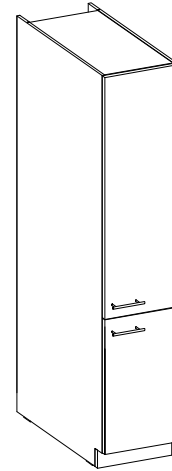
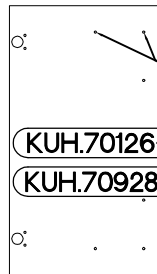
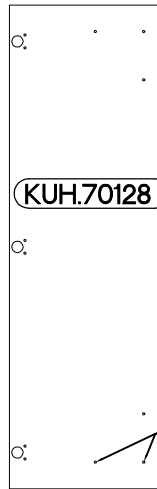
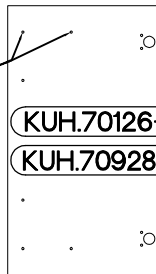
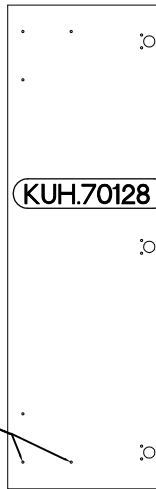
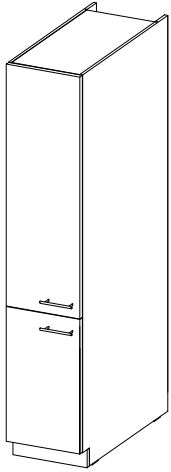
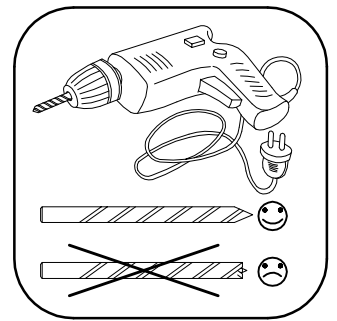

RIGHT



2

$\pm 35/0\text{mm}$  [CD] HG	$\pm 3.5 \times 13\text{mm}$  P5
5	10

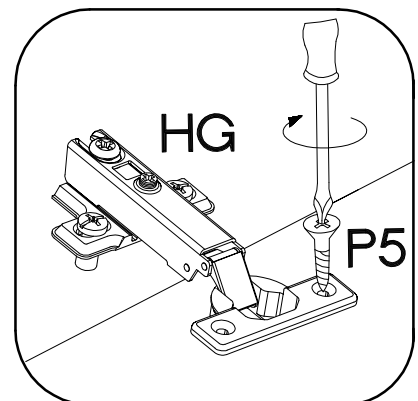
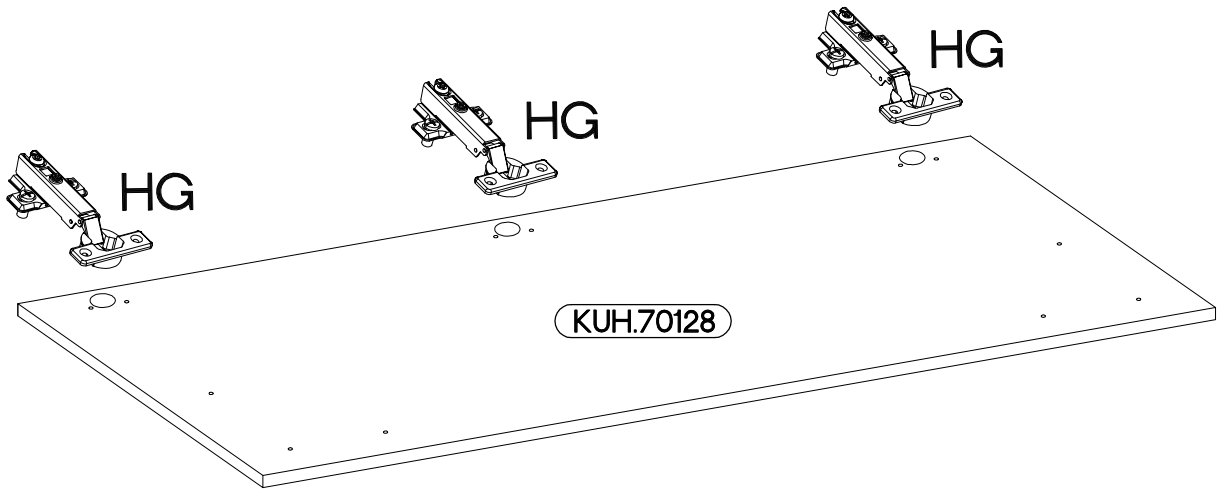
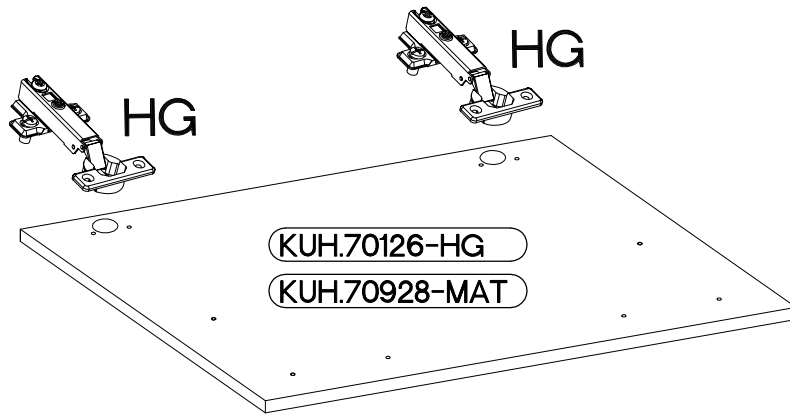

3

M4x22mm

L=128mm



U

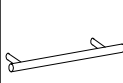

S

4

2

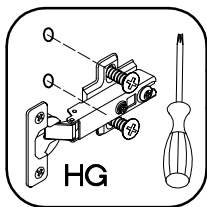

KUH.70128



KUH.70126-HG
KUH.70928-MAT

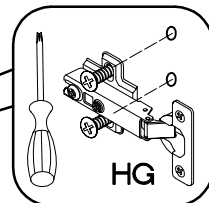

HG

KUH.70128



KUH.70126-HG
KUH.70928-MAT

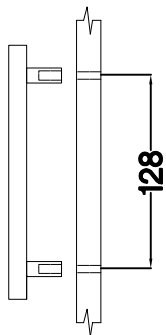
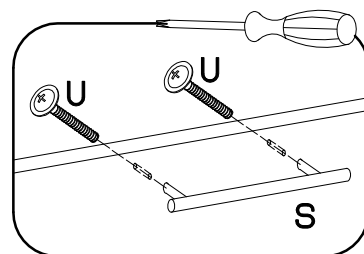

VARIANT HIGH GLOSS

