

VEGAS 13

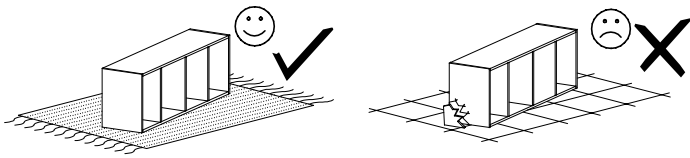

Narzędzia potrzebne do montażu

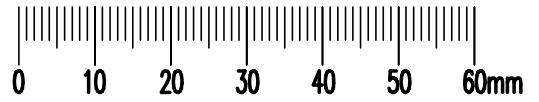
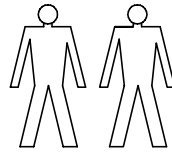
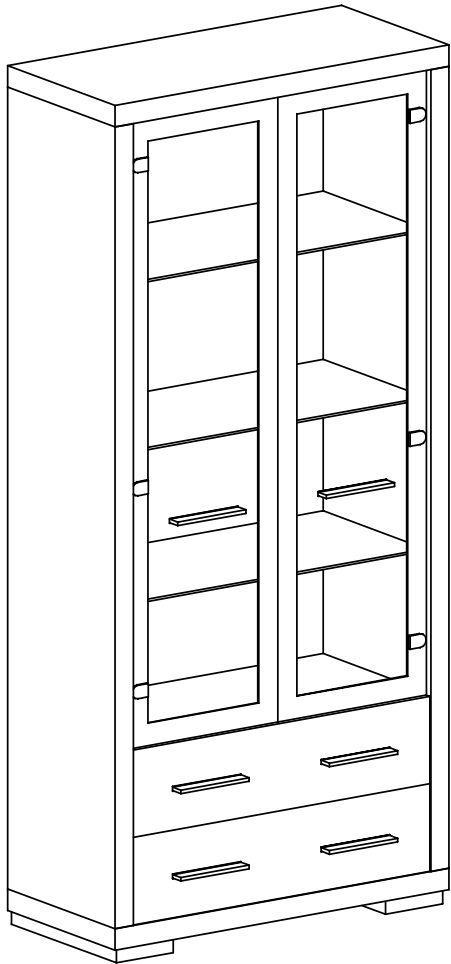
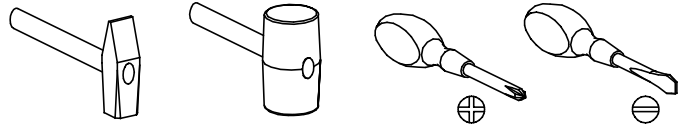

UWAGA !!!

MONTOWANIE USZKODZONYCH
ELEMENTÓW POWODUJE UTRATĘ
GWARANCJI

| Nr | D[mm] | S[mm] | G[mm] | Ilość |
|----|-------|-------|-------|-------|
| 1 | 883 | 407 | 48 | 1 |
| 2 | 883 | 407 | 48 | 1 |
| 3 | 1793 | 405 | 48 | 1 |
| 4 | 1793 | 405 | 48 | 1 |
| 5 | 848 | 398 | 16 | 1 |
| 6 | 848 | 320 | 4 | 3 |
| 7 | 350 | 165 | 16 | 2 |
| 8 | 727 | 165 | 16 | 2 |
| 9 | 350 | 165 | 16 | 2 |
| 10 | 757 | 355 | 2,5 | 2 |
| 11 | 780 | 190 | 16 | 2 |
| 12 | 1820 | 870 | 2,5 | 1 |
| 13 | 388 | 1394 | 4 | 1 |
| 14 | 388 | 1394 | 4 | 1 |

W przypadku reklamacji proszę podać numer pakowacza znajdujący się na kartonie.

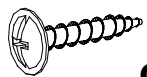

Q - 4 St.
3,5x16 mm

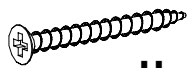

H - 6 St.
4x60 mm

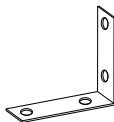

Y - 2 St.



I - 4 St.



M - 60 St.
3x30 mm



G - 4 St.
4x20 mm



F - 8 St.



P - 14 St.



N - 8 St.
4x30 mm



U - 6 St.

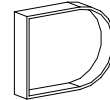

R - 6 St.



L - 16 St.

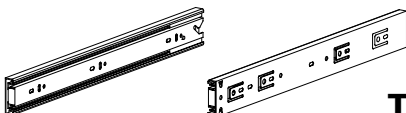

T - 2 Kpl.

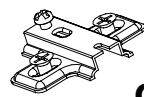

C - 6 St.

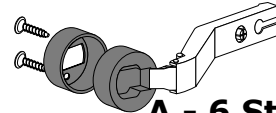

A - 6 St.



S - 1 St.



E - 70 St.



B - 20 St.

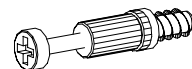

K - 16 St.

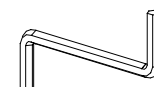

Z - 1 St.



J - 16 St.
5x13 mm

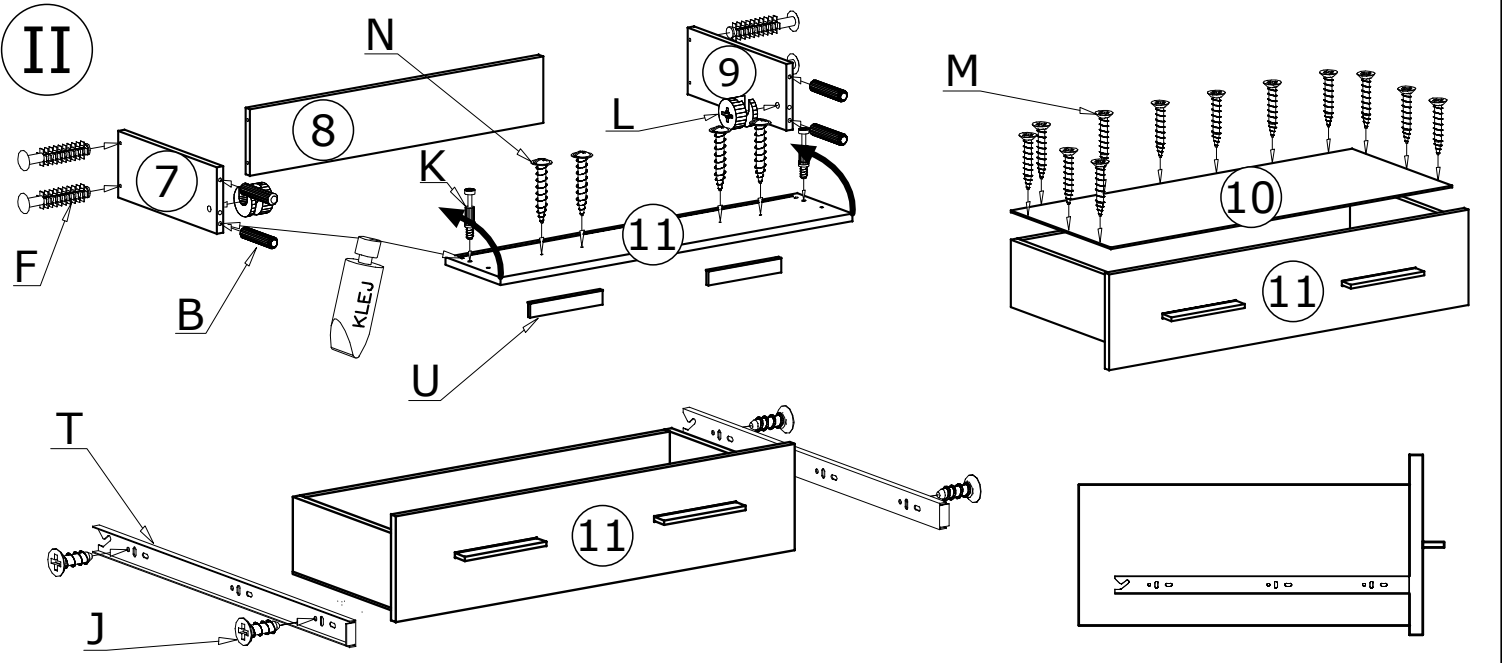
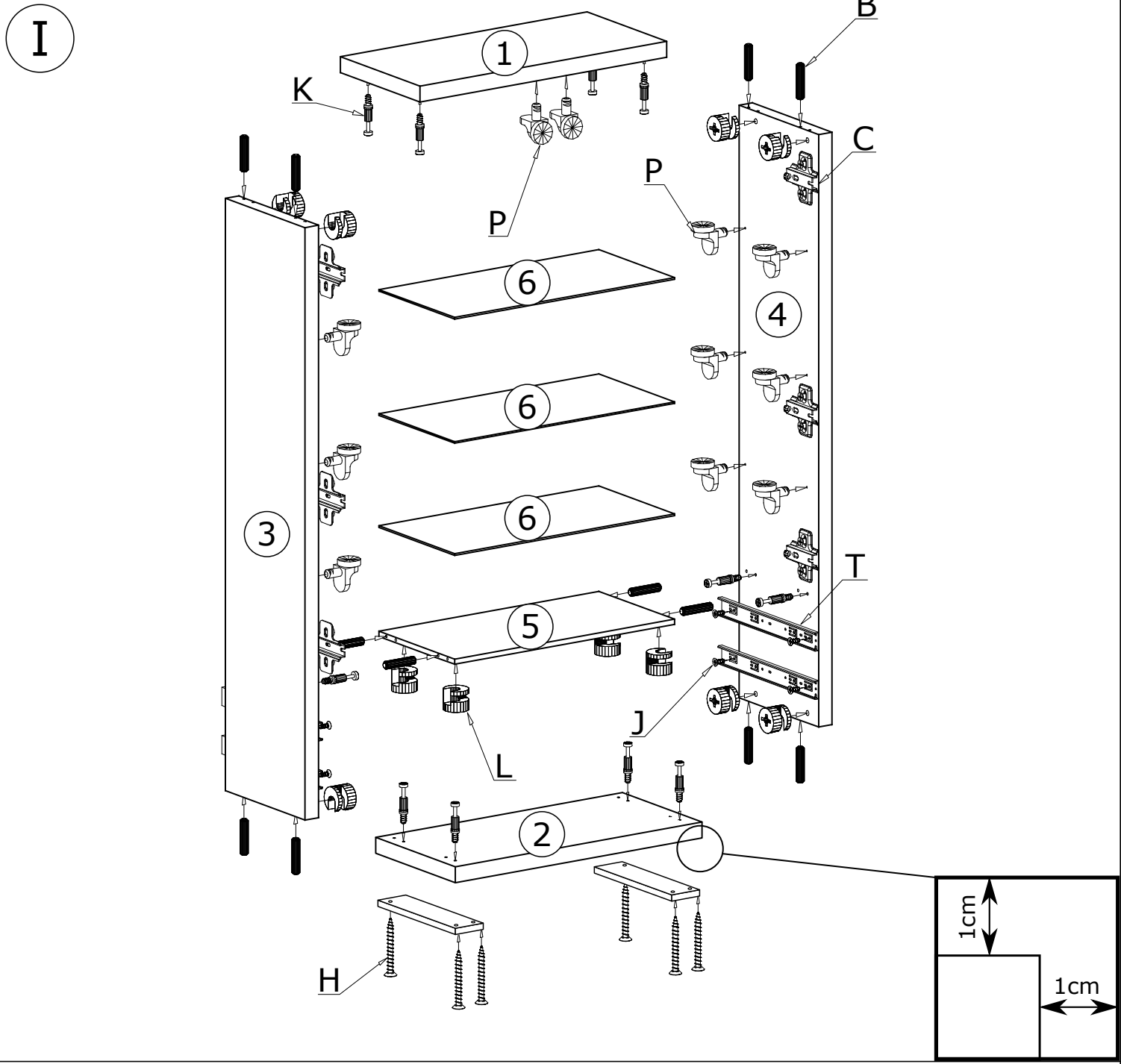

III

70X 

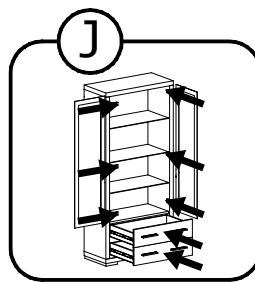
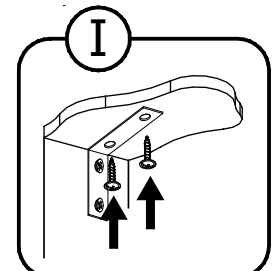
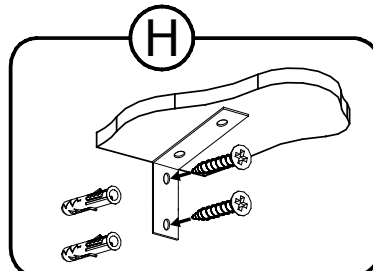
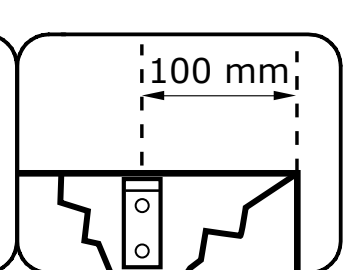
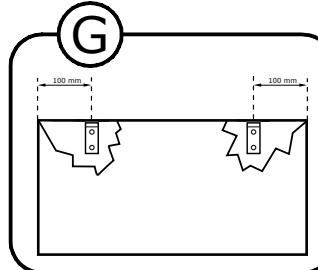
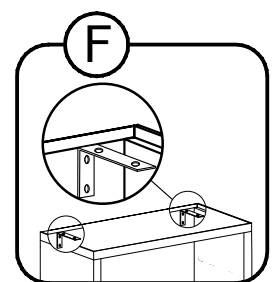
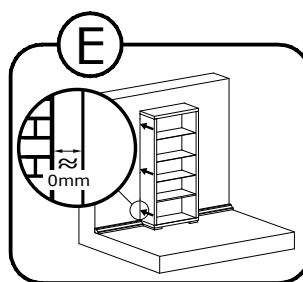
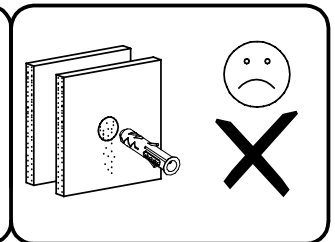
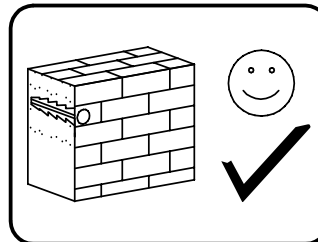
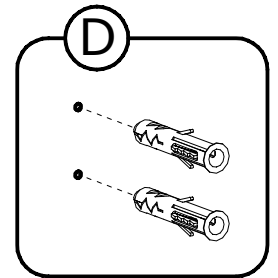
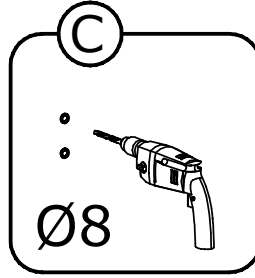
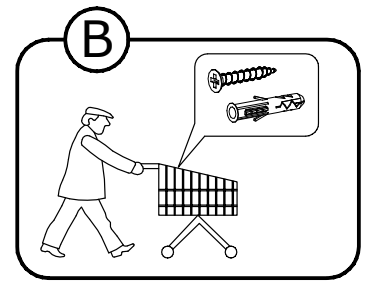
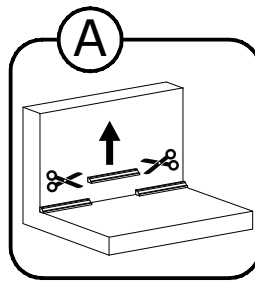
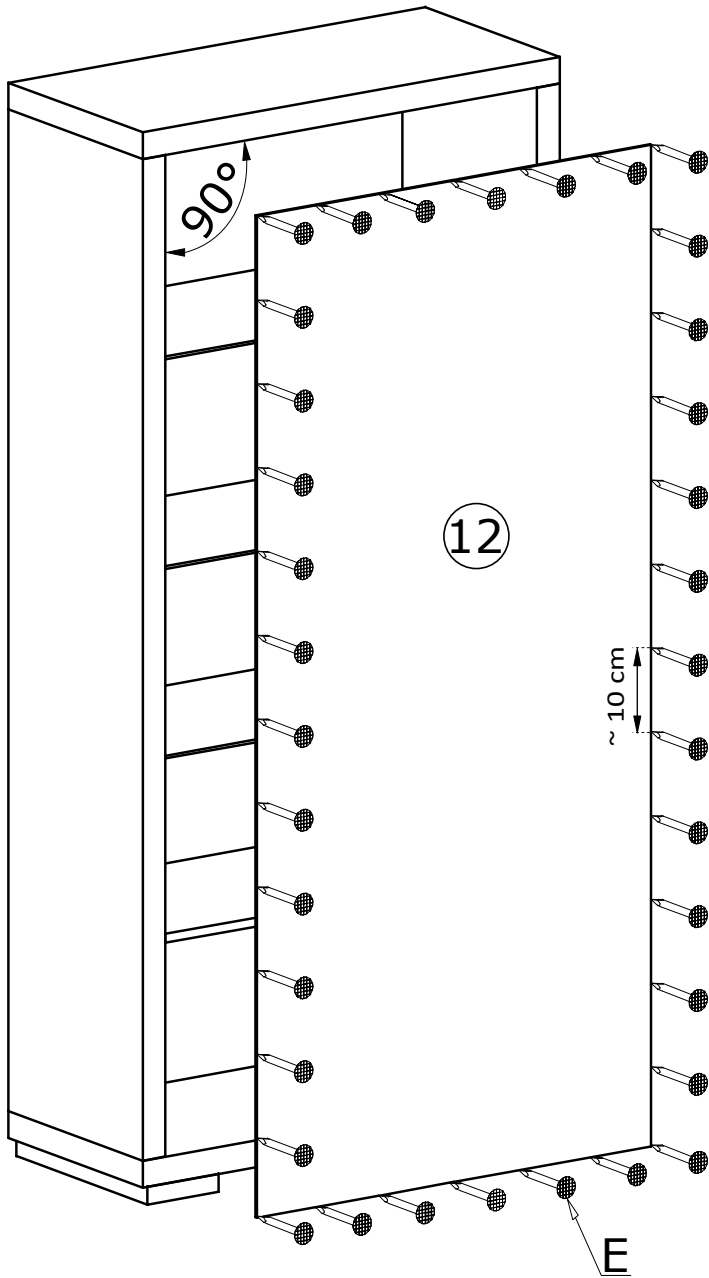

IV

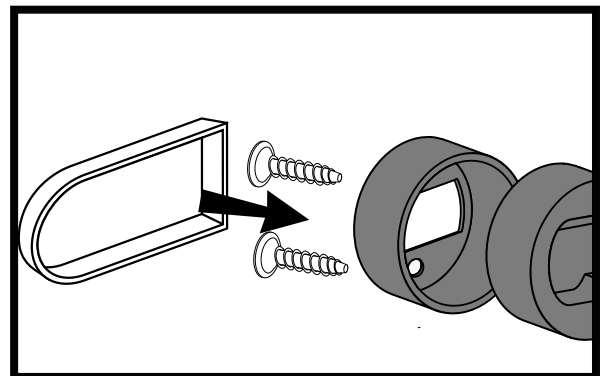
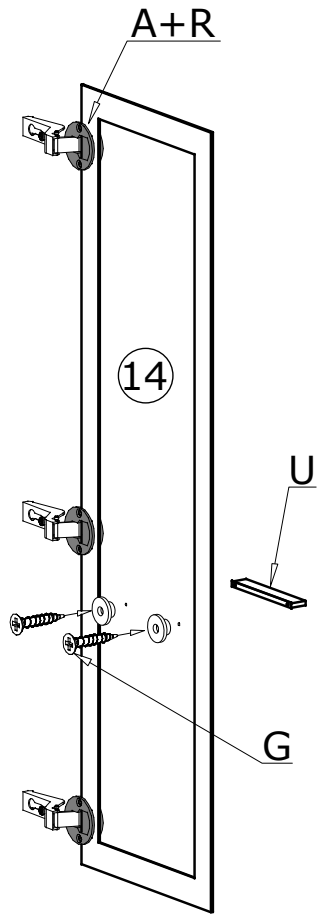
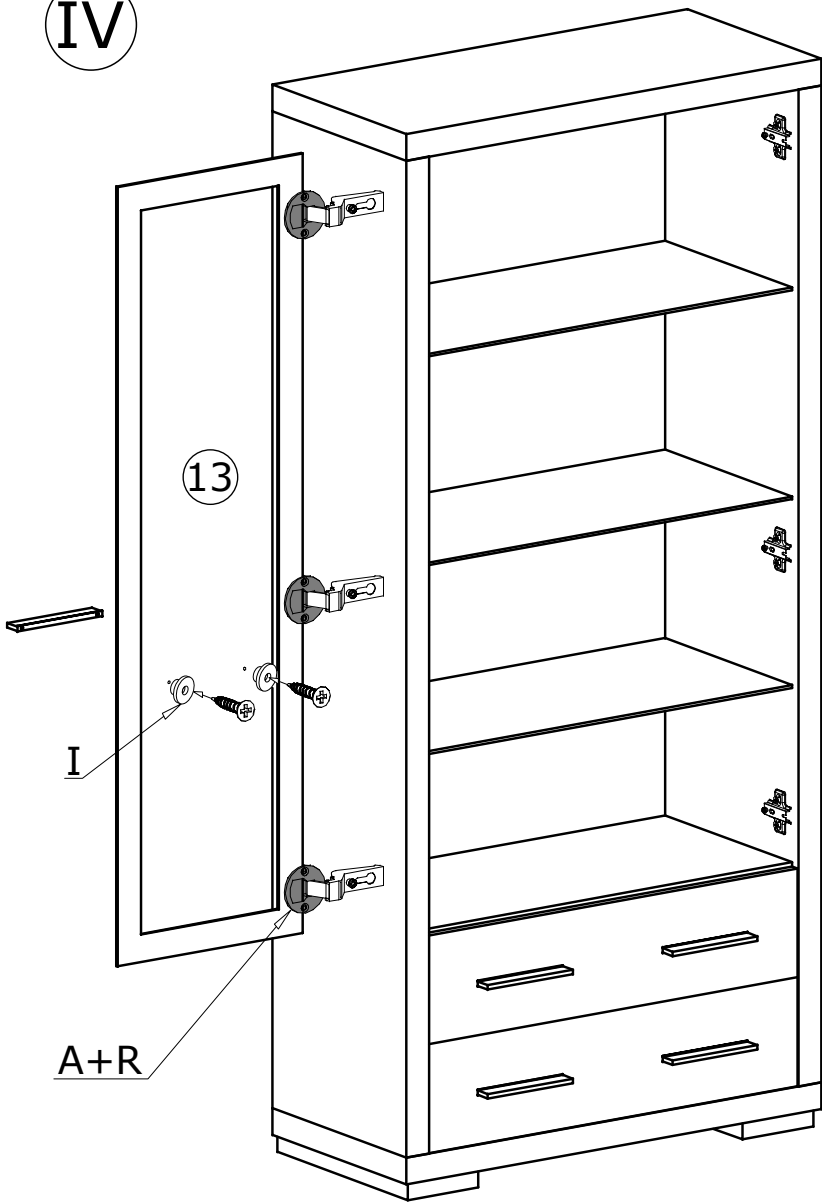

MONTAŻ/DEMONTAŻ PROWADNIC

1



2

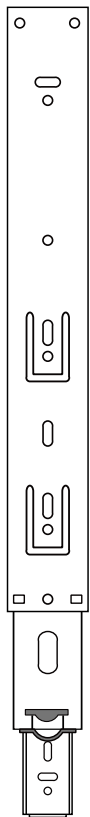

3

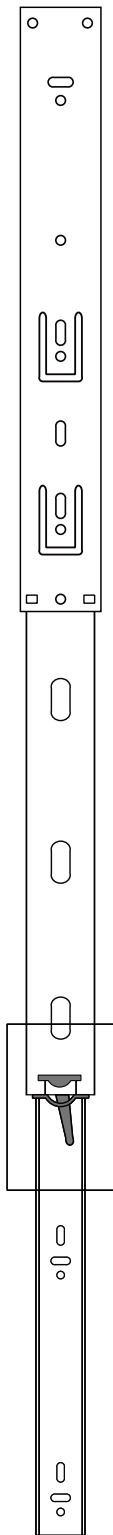

4

