

VEGAS 12

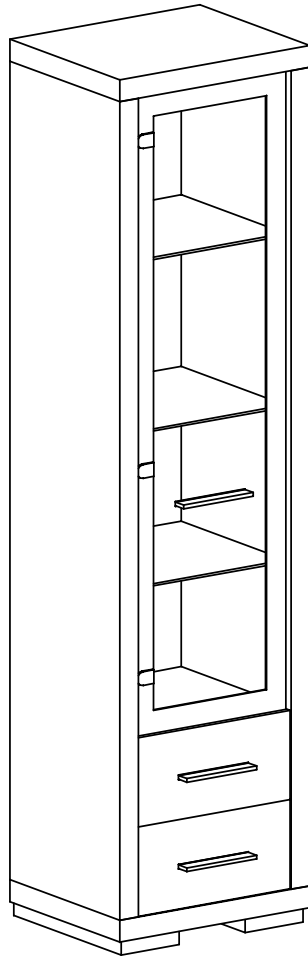

Narzędzia potrzebne do montażu



UWAGA !!!

MONTOWANIE USZKODZONYCH
ELEMENTÓW POWODUJE UTRATĘ
GWARANCJI

| Nr | D[mm] | S[mm] | G[mm] | Ilość |
|----|-------|-------|-------|-------|
| 1 | 493 | 407 | 48 | 1 |
| 2 | 493 | 407 | 48 | 1 |
| 3 | 1793 | 405 | 48 | 1 |
| 4 | 1793 | 405 | 48 | 1 |
| 5 | 458 | 398 | 16 | 1 |
| 6 | 457 | 320 | 4 | 1 |
| 7 | 350 | 165 | 16 | 2 |
| 8 | 336 | 165 | 16 | 2 |
| 9 | 350 | 165 | 16 | 2 |
| 10 | 362 | 355 | 2,5 | 2 |
| 11 | 388 | 190 | 16 | 2 |
| 12 | 1820 | 480 | 2,5 | 1 |
| 13 | 388 | 1394 | 4 | 1 |

W przypadku reklamacji proszę podać numer pakowacza znajdujący się na kartonie.

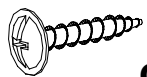

Q - 4 St.
3,5x16 mm

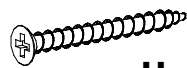

H - 6 St.
4x60 mm

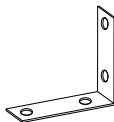

Y - 2 St.

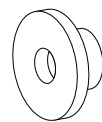

I - 2 St.



M - 30 St.
3x30 mm



G - 2 St.
4x20 mm

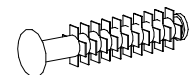

F - 8 St.

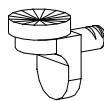

P - 13 St.



N - 4 St.
4x30 mm



U - 3 St.

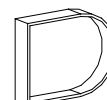

R - 3 St.



L - 12 St.

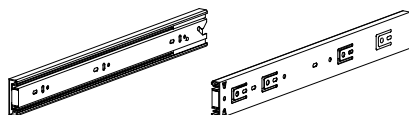

T - 2 Kpl.

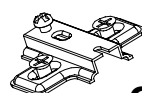

C - 3 St.

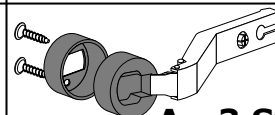

A - 3 St.



S - 1 St.



E - 60 St.

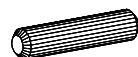

B - 20 St.

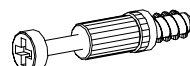

K - 12 St.

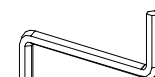

Z - 1 St.



J - 16 St.
5x13 mm

I

1

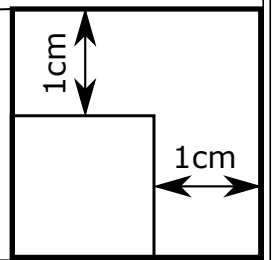
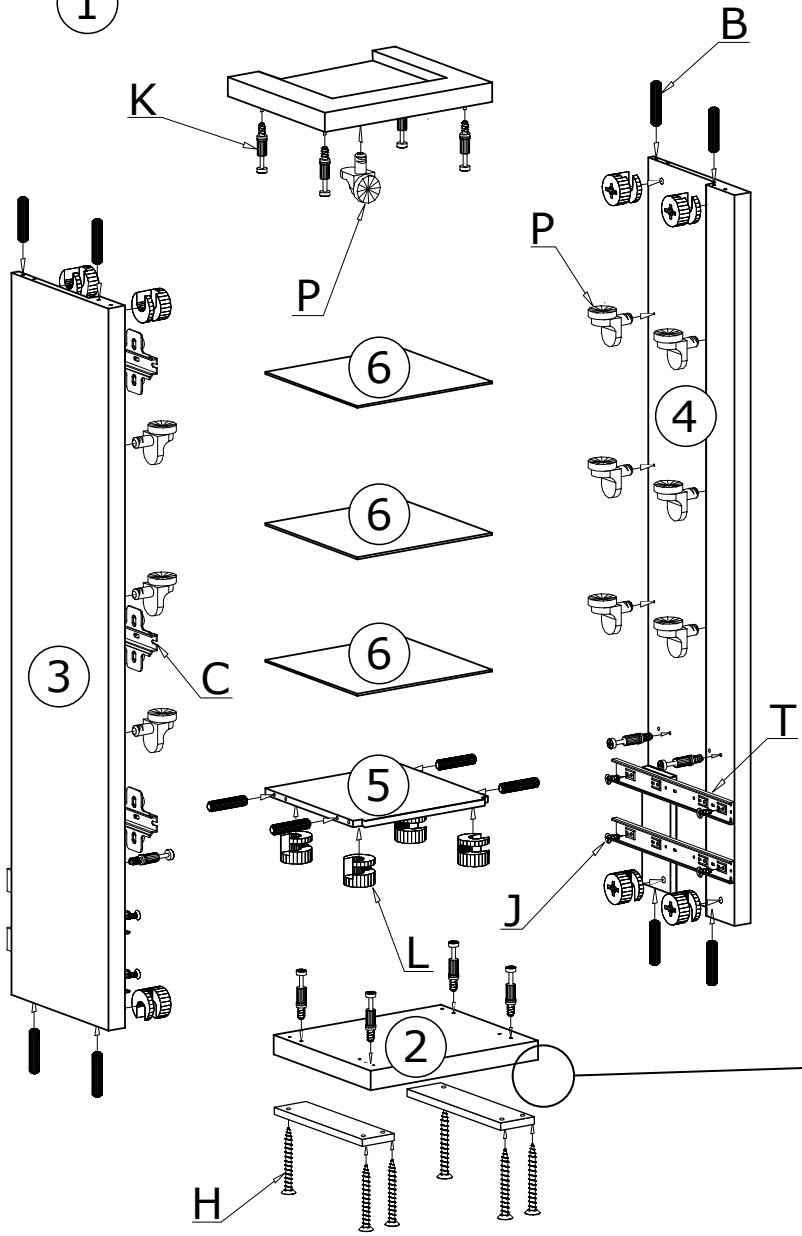

II

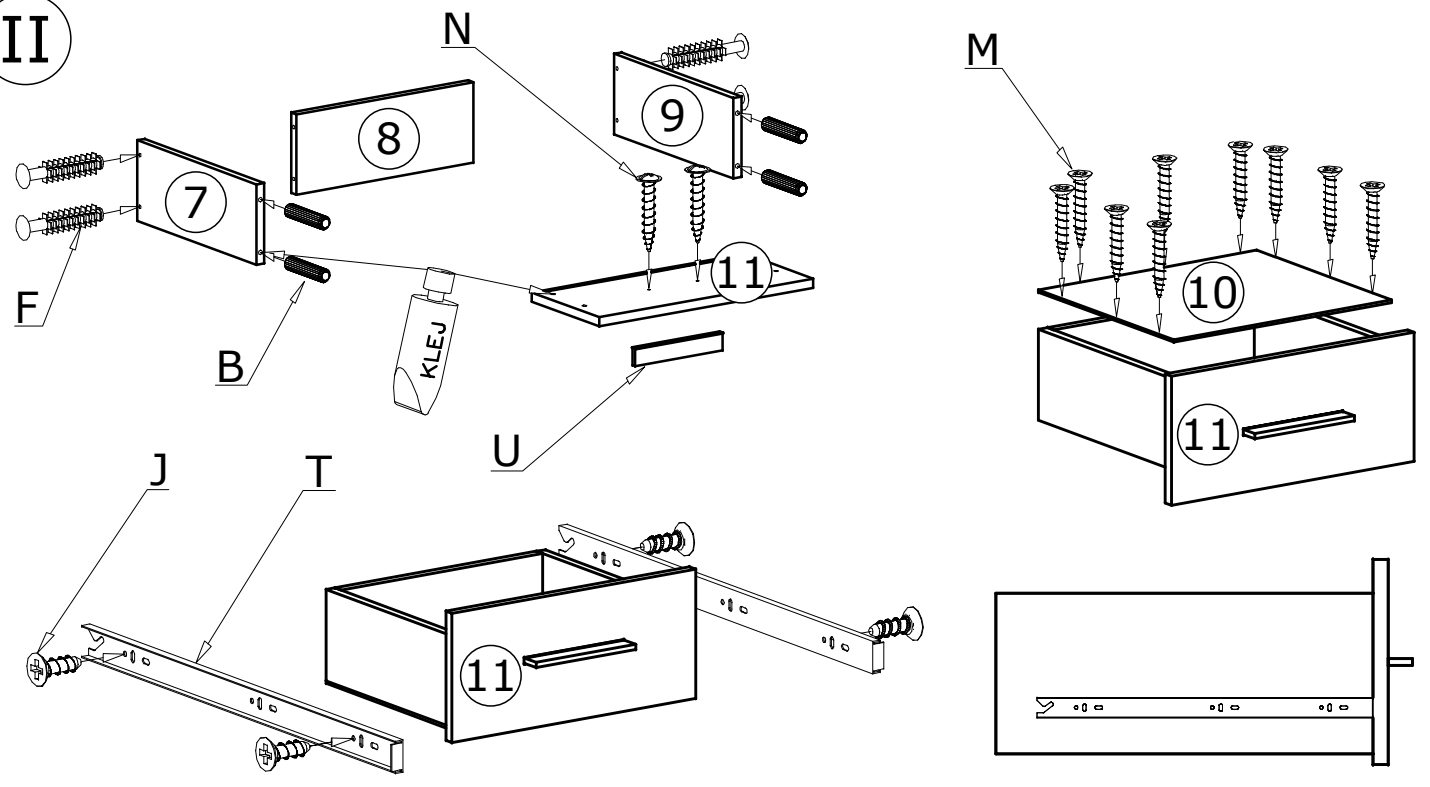

III

60X 

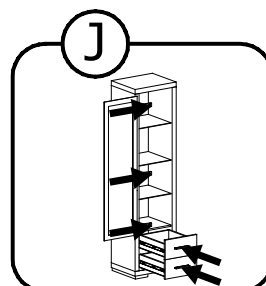
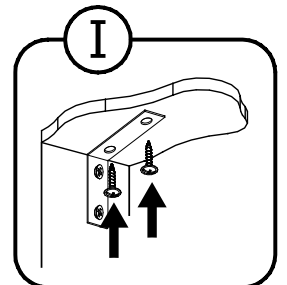
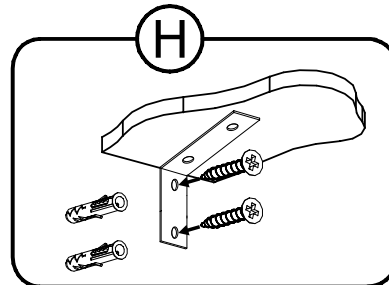
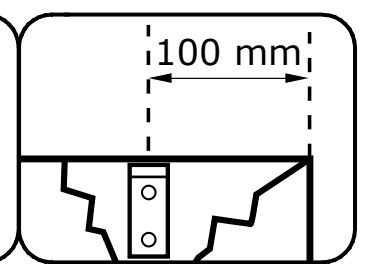
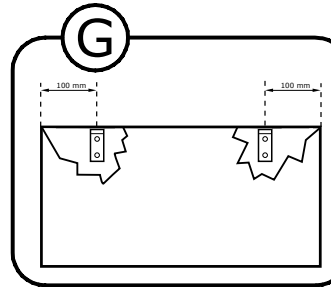
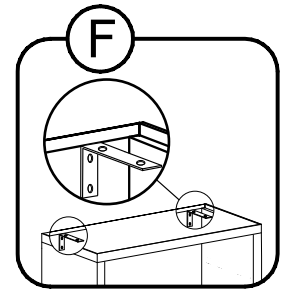
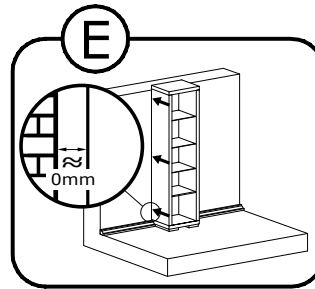
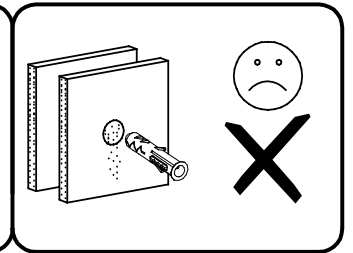
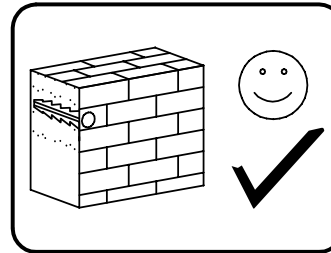
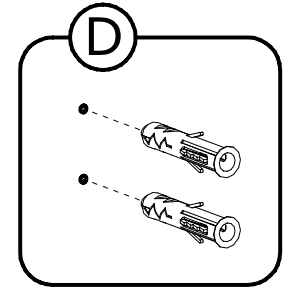
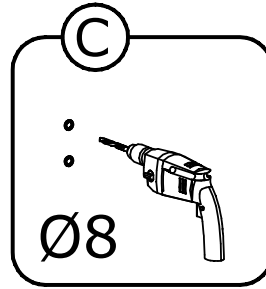
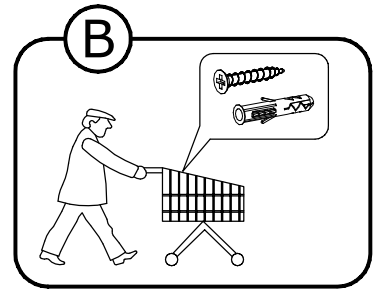
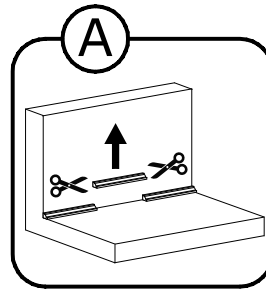
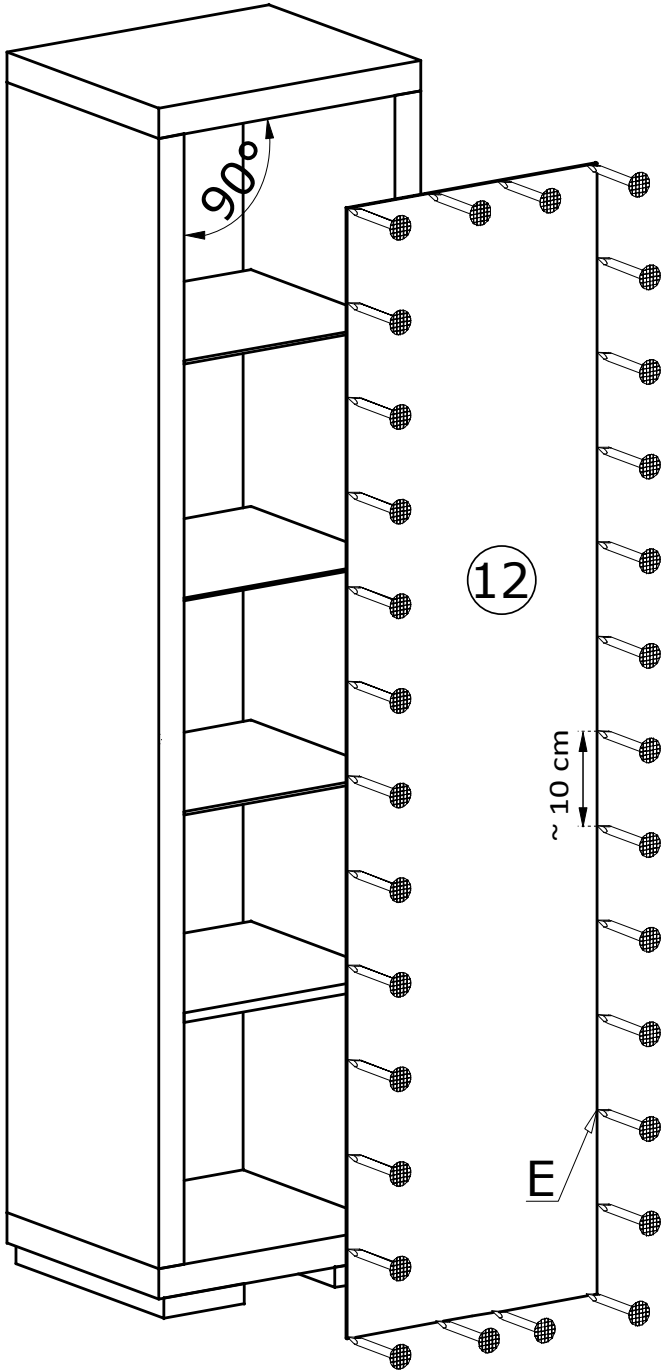

IV

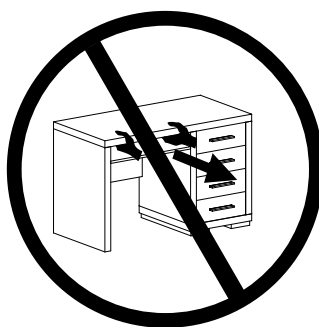
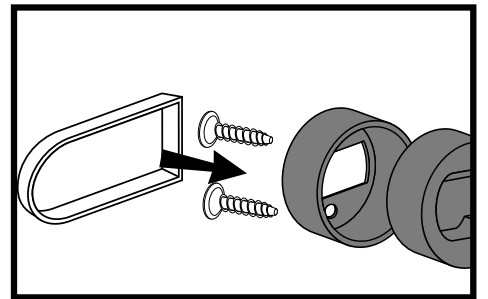
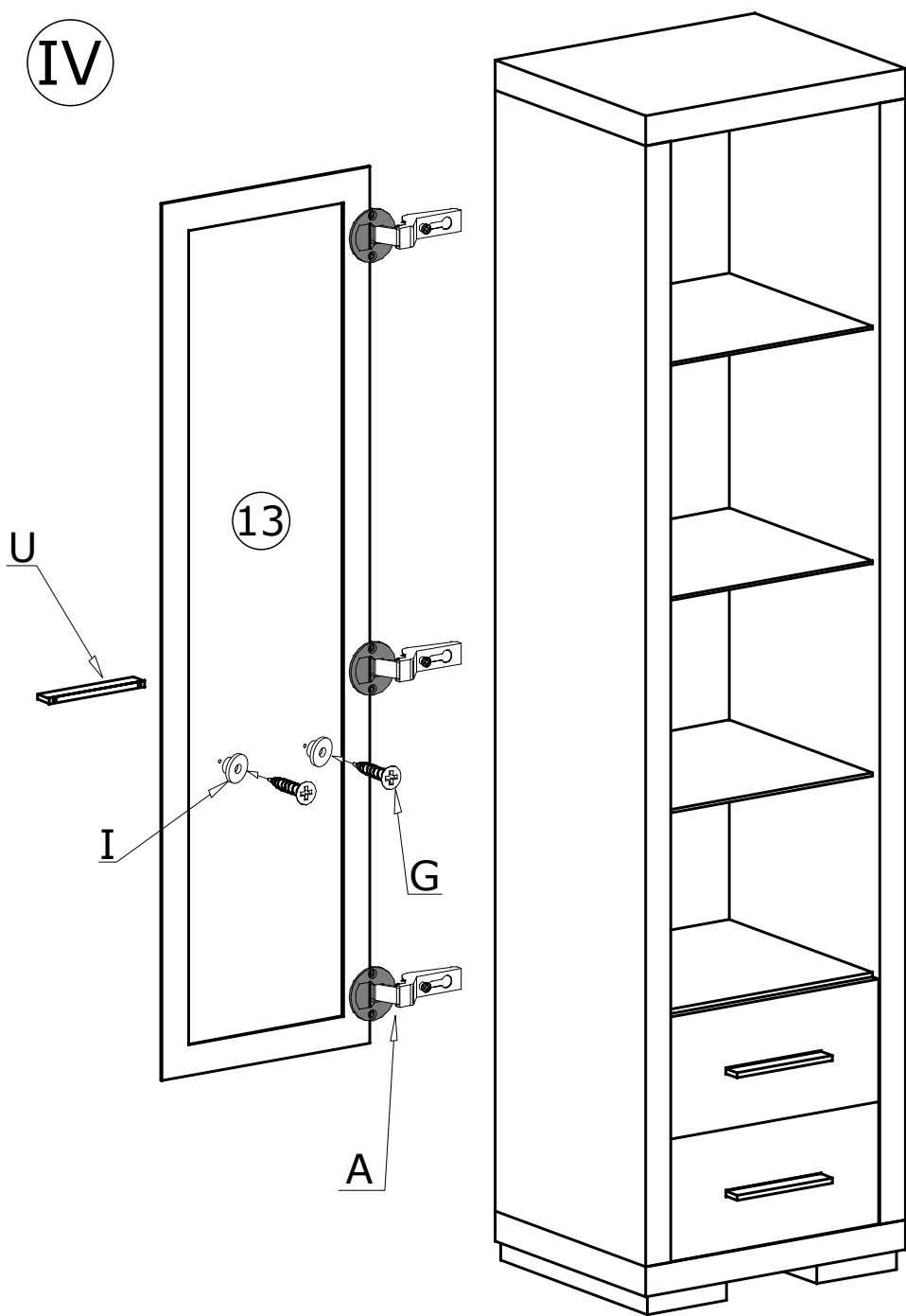

MONTAŻ/DEMONTAŻ PROWADNIC

1



2



3

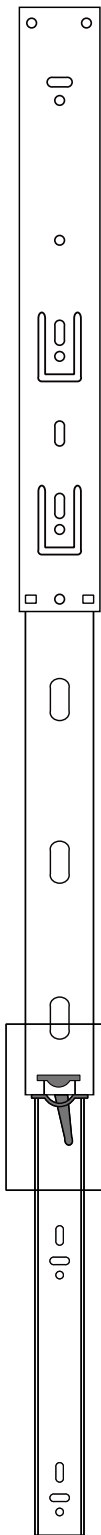

4

