

VEGAS 9

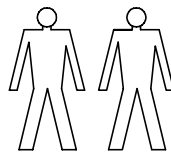

Narzędzia potrzebne do montażu

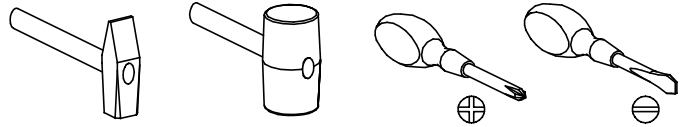

UWAGA !!!

MONTEWANIE USZKODZONYCH
ELEMENTÓW POWODUJE UTRATĘ
GWARANCJI

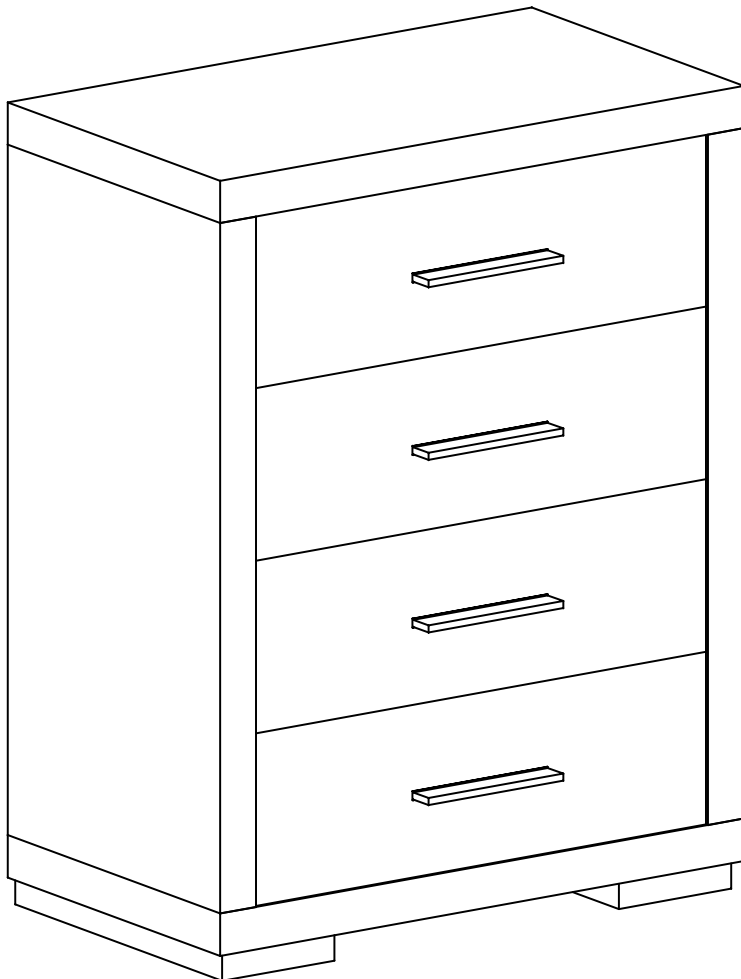

Nr	D[mm]	S[mm]	G[mm]	Ilość
1	703	407	48	1
2	703	407	48	1
3	783	405	48	1
4	783	405	48	1
5	690	834	2,5	1
6	597	190	16	4
7	350	165	16	4
8	544	165	16	4
9	350	165	16	4
10	575	690	2,5	4

W przypadku reklamacji proszę podać numer pakowacza znajdujący się na kartonie.

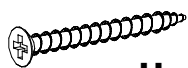

H - 6 St.
4x60 mm



X1 - 8 St.

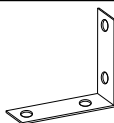

Y - 2 St.

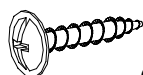

Q - 4 St.
3,5x16 mm



M - 80 St.
3x30 mm

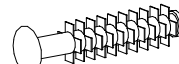

F - 16 St.



L - 16 St.

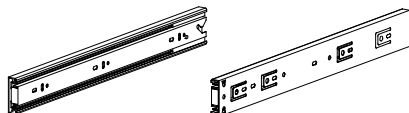

T - 4 Kpl.



N - 8 St.
4x30 mm



U - 4 St.



S - 1 St.



E - 40 St.



B - 24 St.

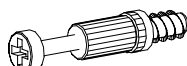

K - 16 St.

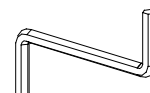

Z - 1 St.



J - 32 St.
5x13 mm

I

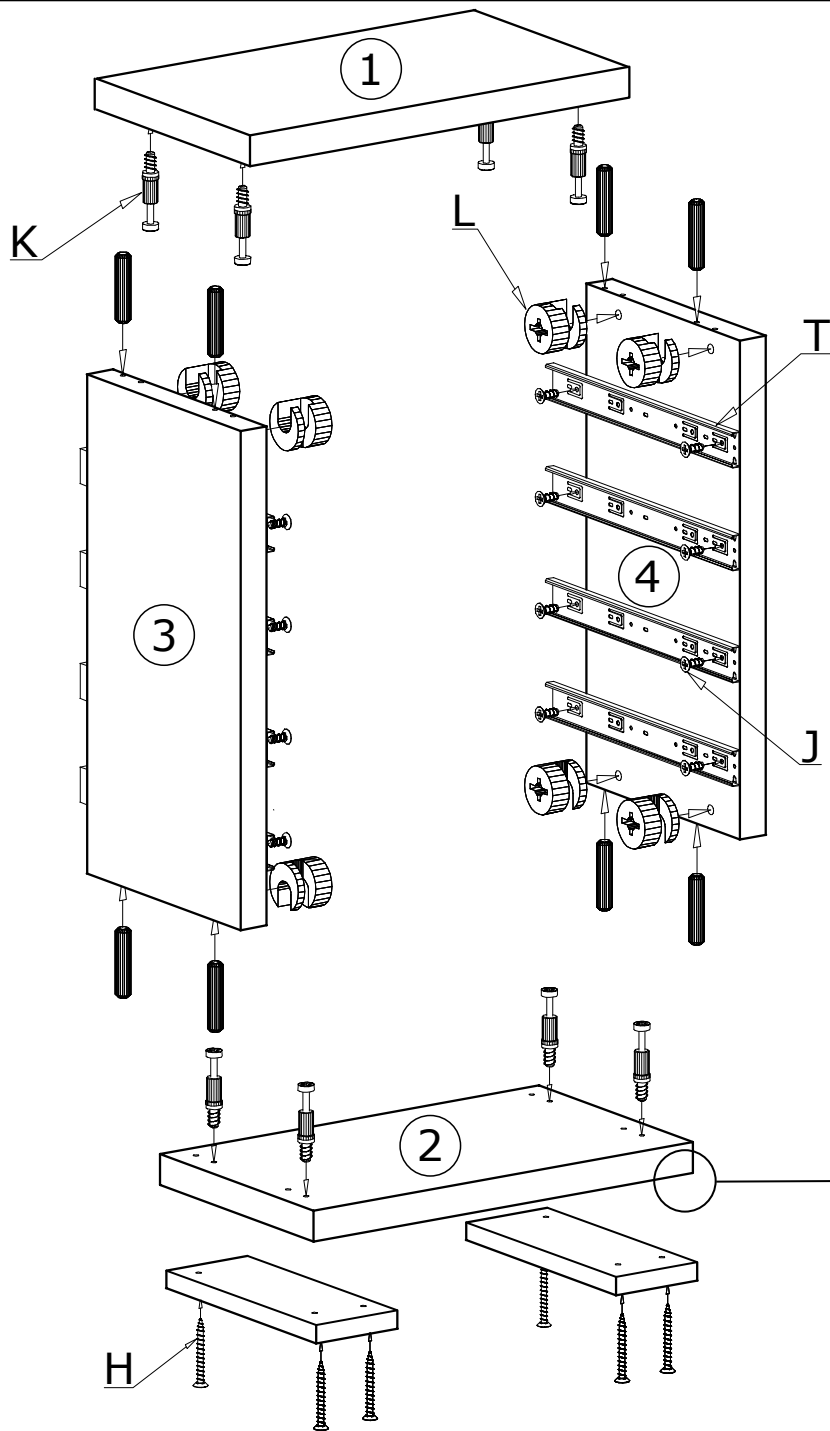

II

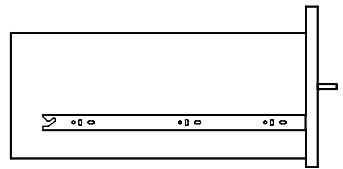
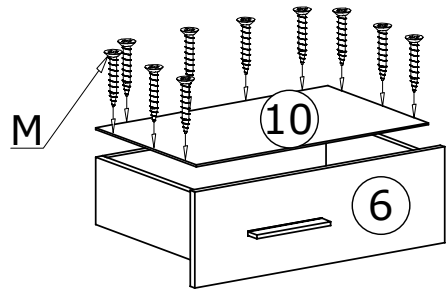
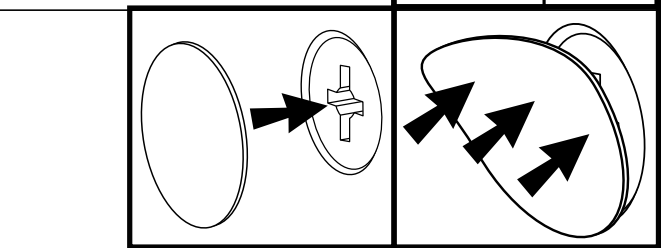
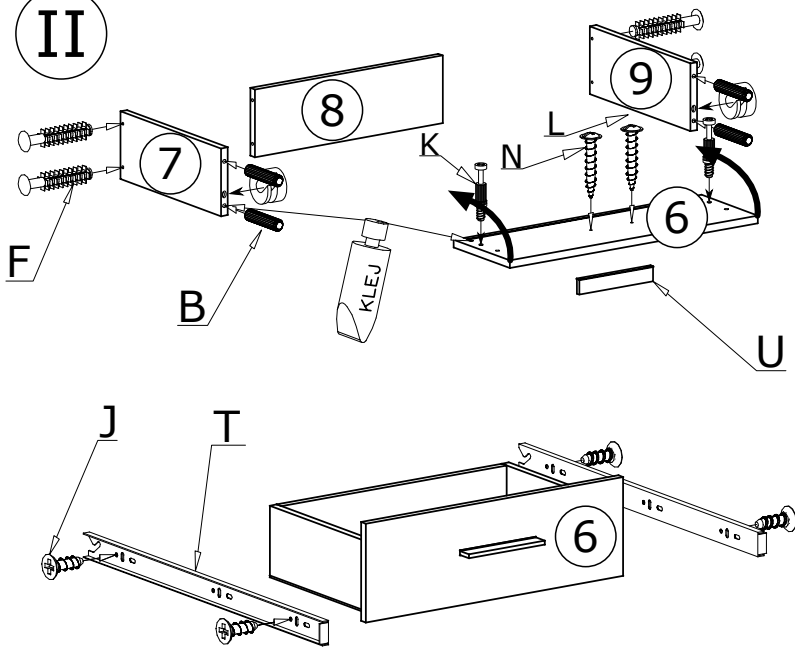

III

40X 

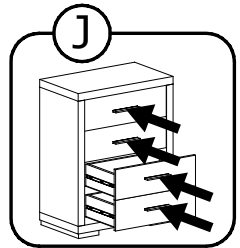
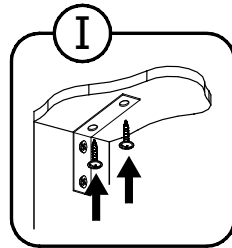
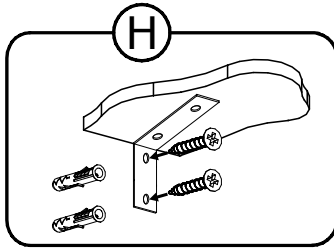
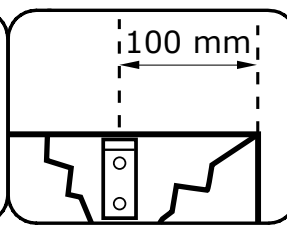
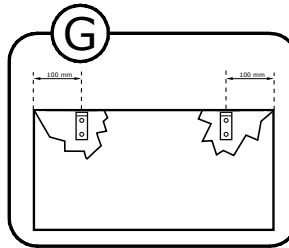
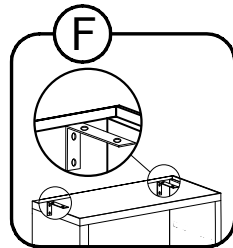
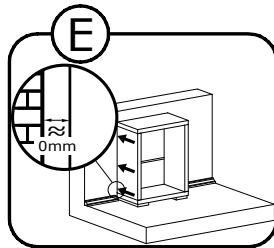
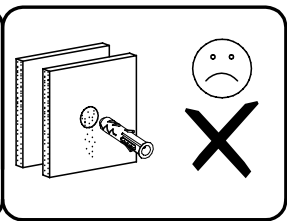
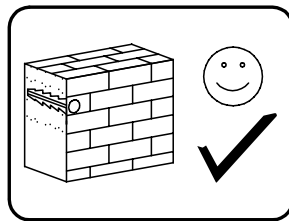
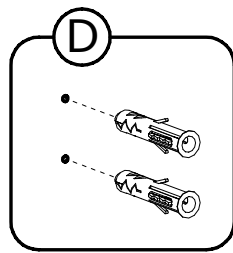
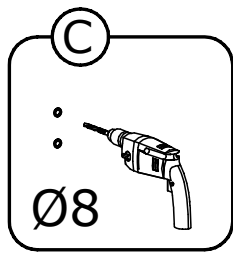
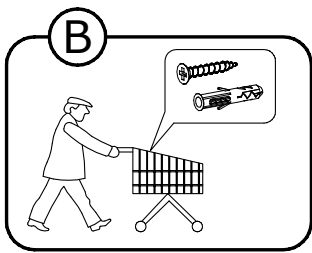
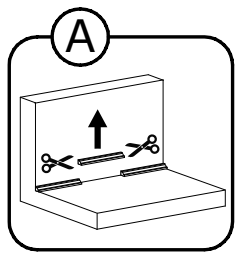
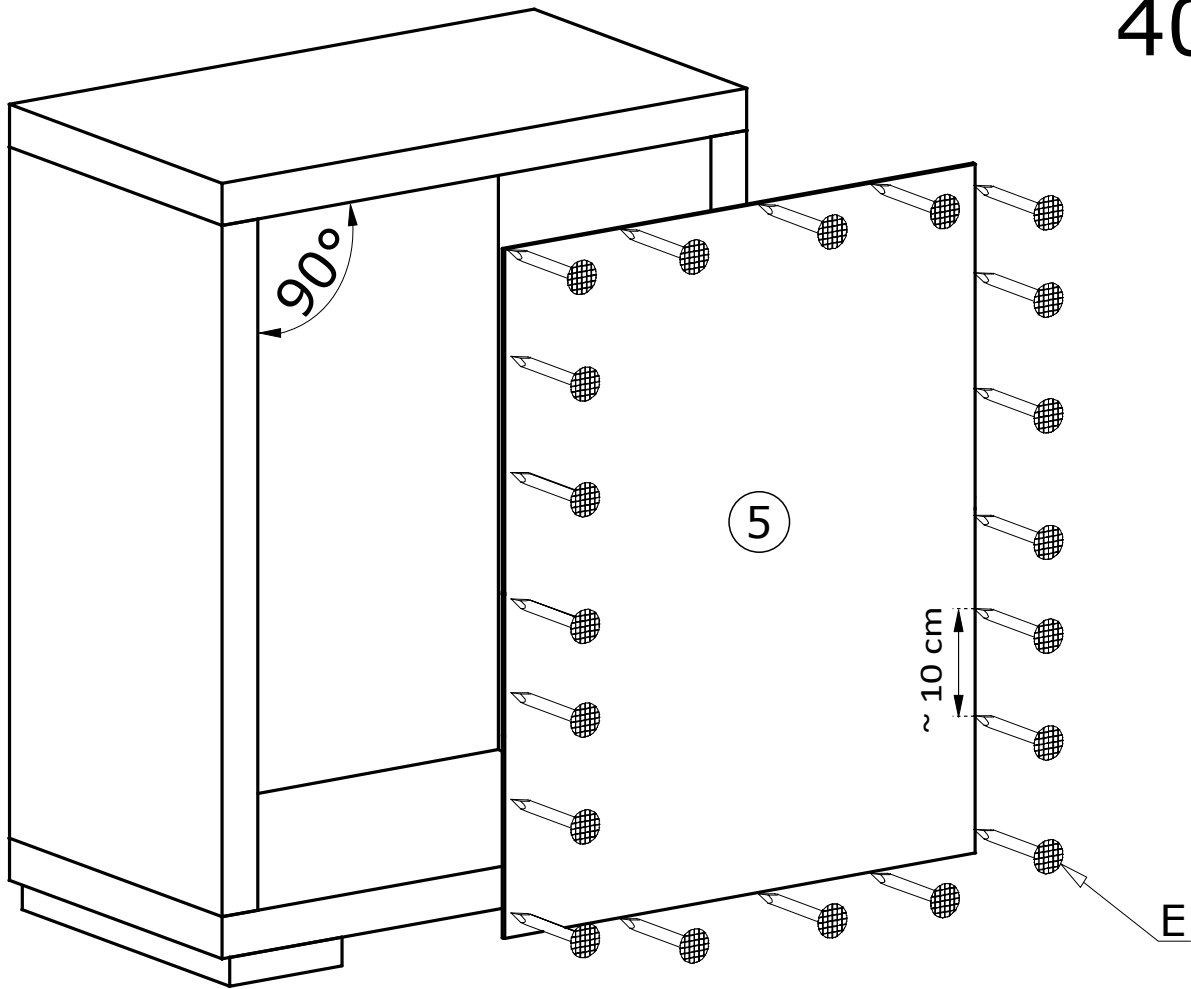

IV

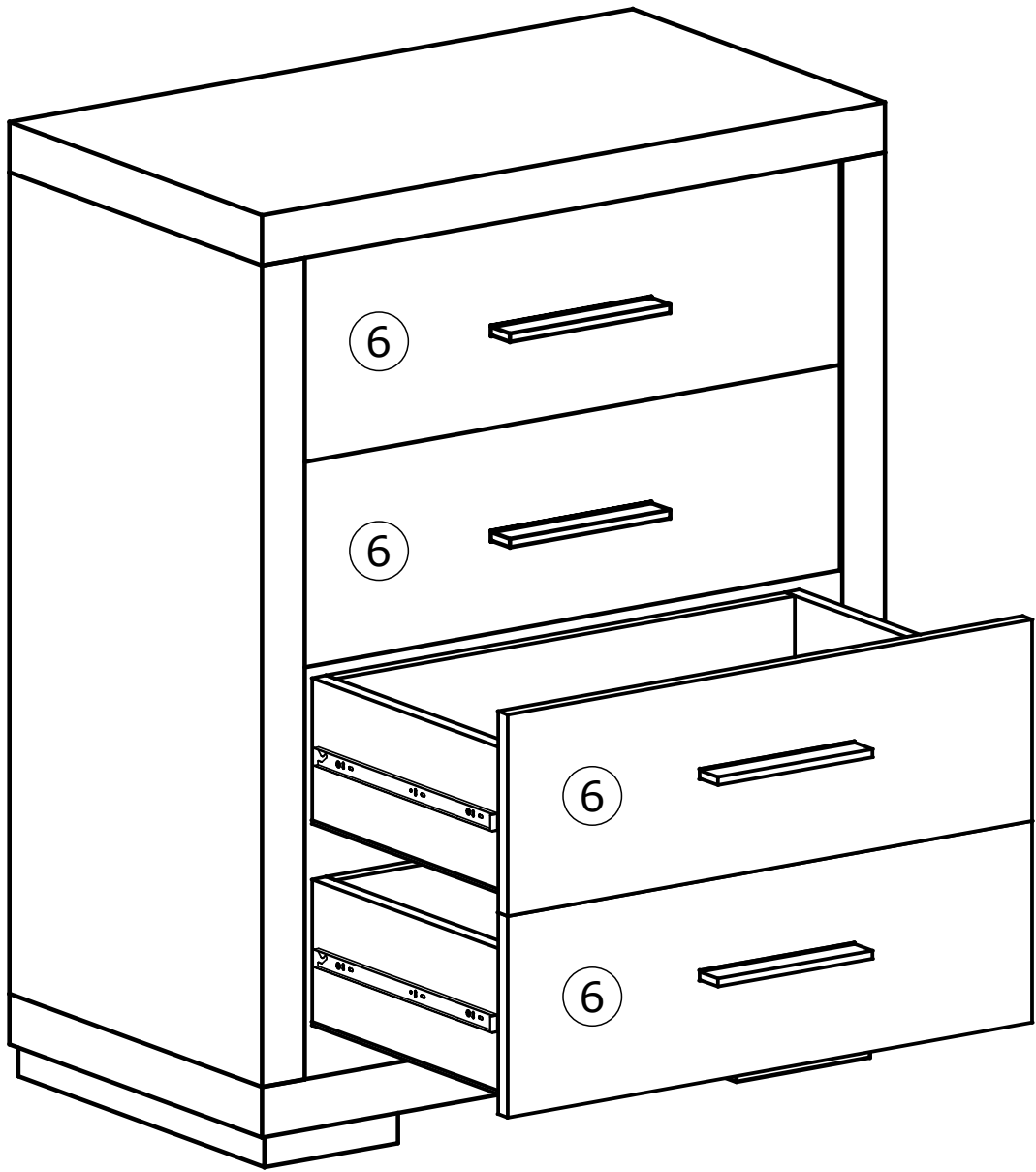

MONTAŻ/DEMONTAŻ PROWADNIC

1



2



3

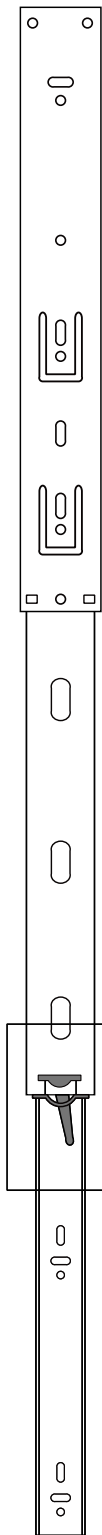

4

