

TADEUSZ 22



Narzędzia potrzebne do montażu



UWAGA !!!

MONTOWANIE USZKODZONYCH
ELEMENTÓW POWODUJE UTRATĘ
GWARANCJI

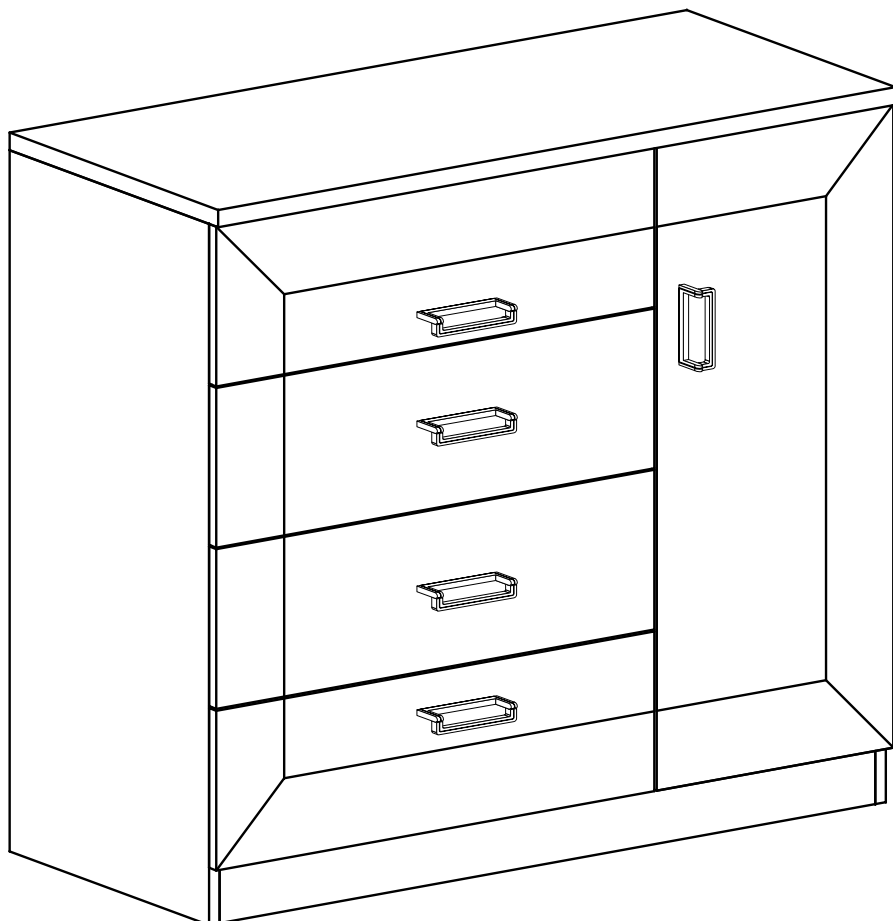

Nr	D[mm]	S[mm]	G[mm]	Ilość
1	1000	440	32	1
2	953	405	16	1
3	769	405	16	1
4	865	405	16	1
5	865	405	16	1
6	953	80	16	1
7	978	806	2,5	1
8	528	150	16	4
9	400	150	16	4
10	400	150	16	4
11	603	190	16	4
12	553	405	2,5	4
13	380	350	16	1
14	777	368	16	1

W przypadku reklamacji proszę podać numer pakowacza znajdujący się na kartonie.

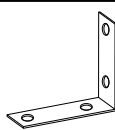

Y - 2 St.



X1 - 2 St.



X2 - 4 St.



X3 - 16 St.

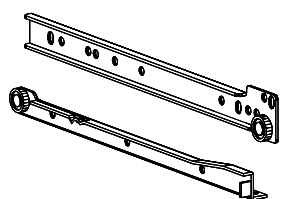

T - 4 Kpl.

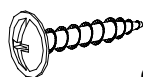

Q - 4 St.
3,5x16 mm



M - 16 St.
4x25 mm



P - 4 St.

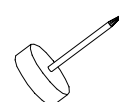

Q - 5 St.

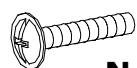

N - 10 St.
4x25 mm



U - 5 St.



G - 4 St.
3,5x16 mm



L - 16 St.

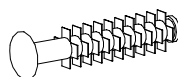

F - 16 St.



E - 120 St.

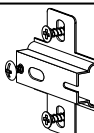

C - 2 St.

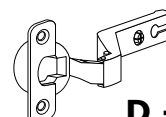

D - 2 St.



S - 1 St.

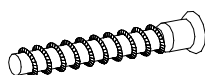

R - 5 St.



B - 32 St.

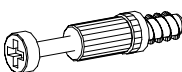

K - 16 St.

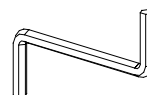

Z - 1 St.



J - 16 St.
5x13 mm

I

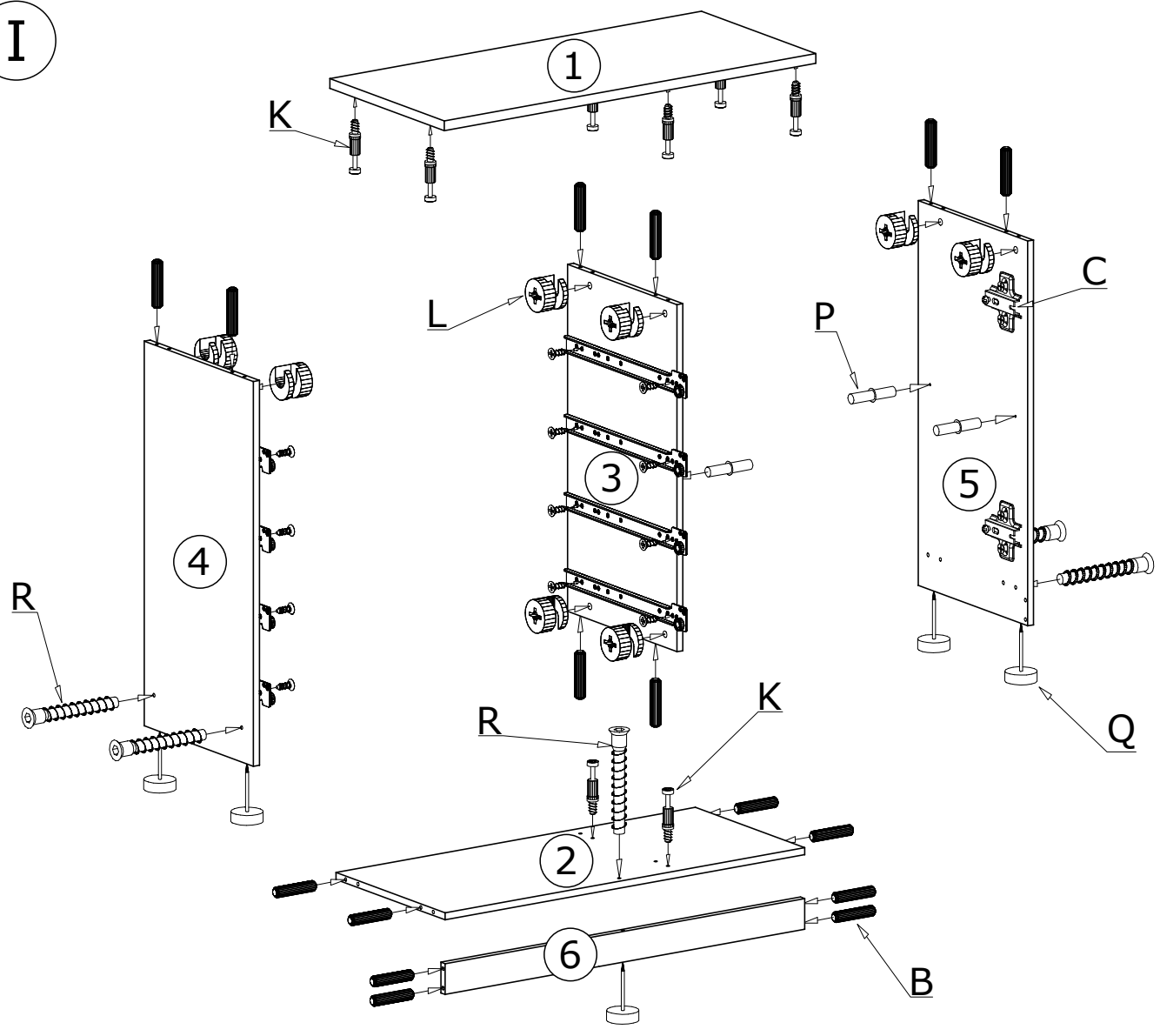

II

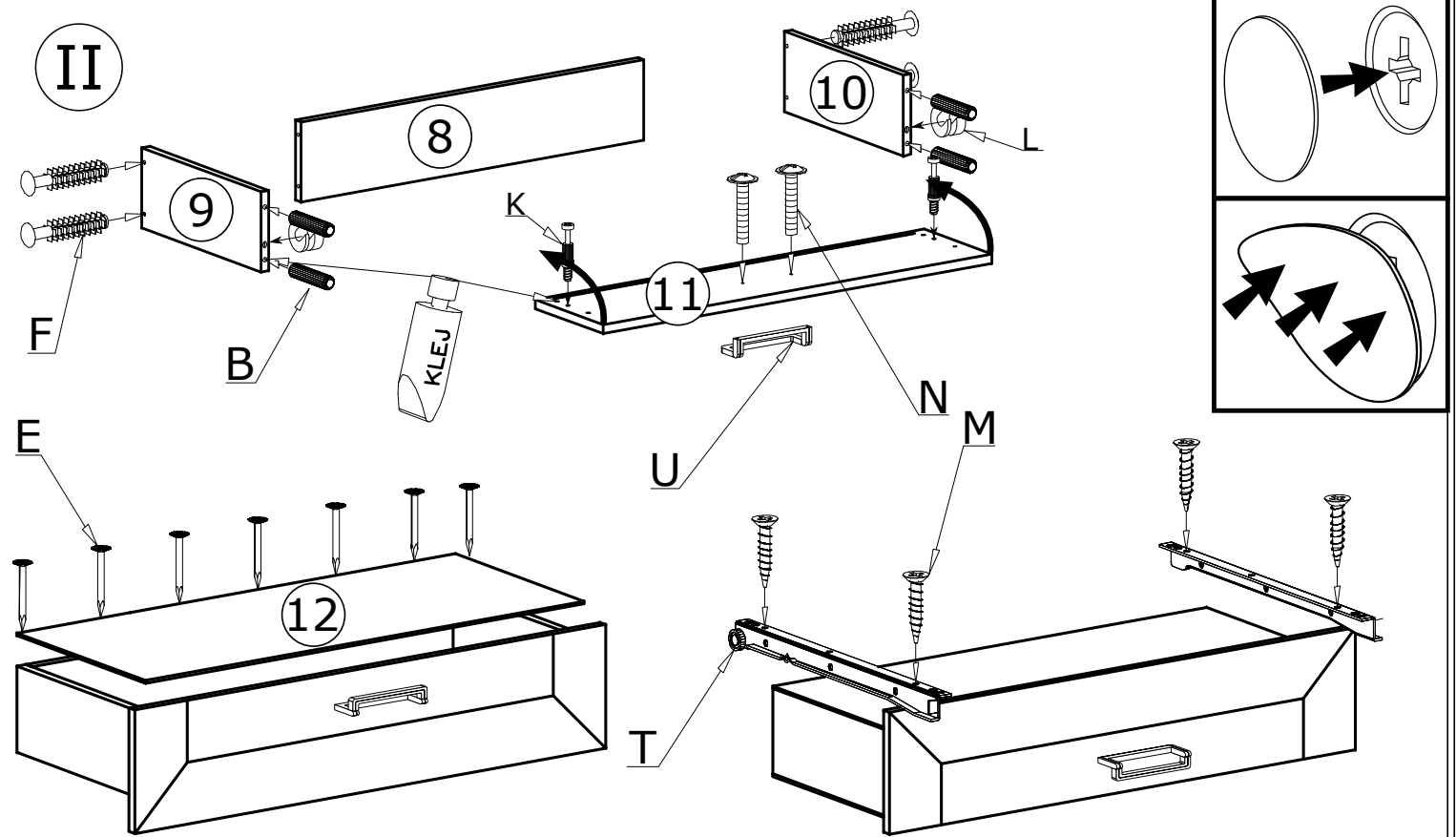

III

120X 

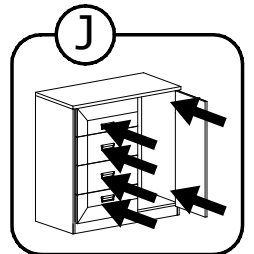
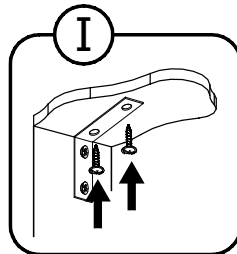
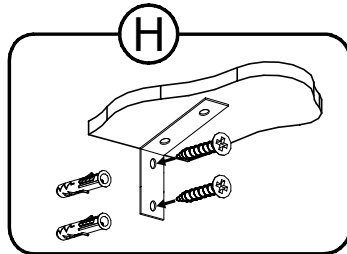
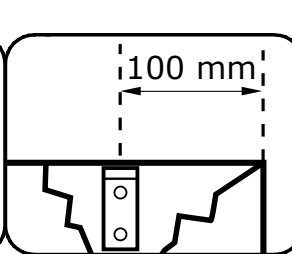
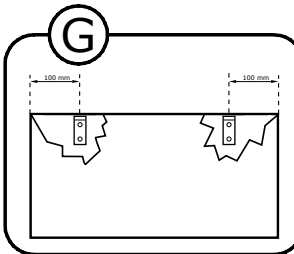
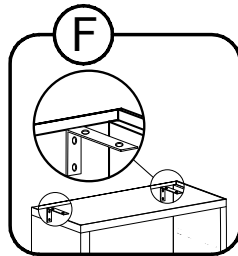
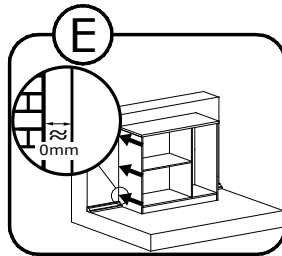
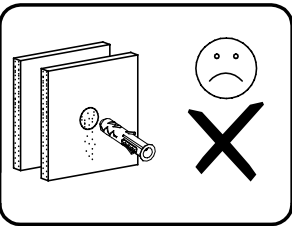
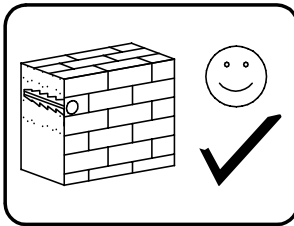
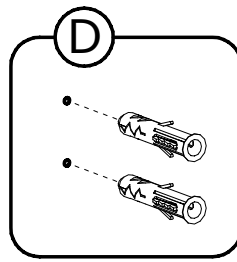
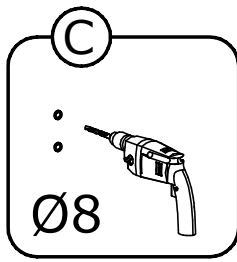
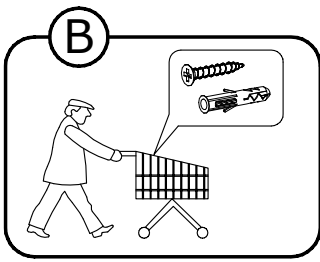
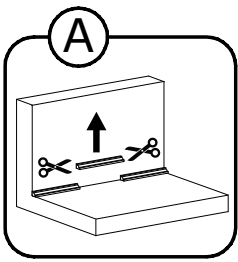
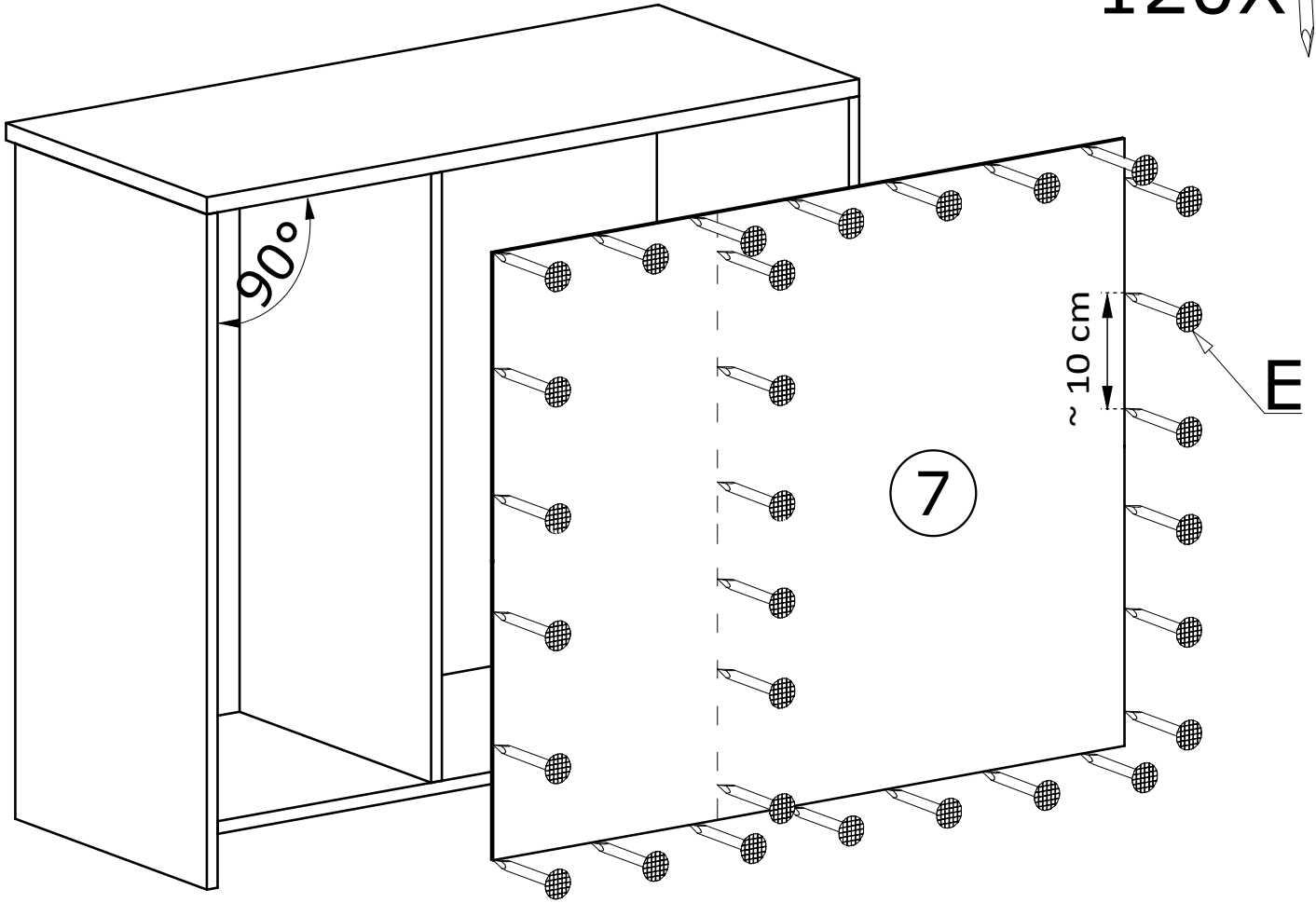

IV

