

KORA 8

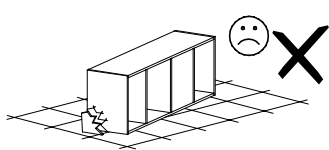

Narzędzia potrzebne do montażu

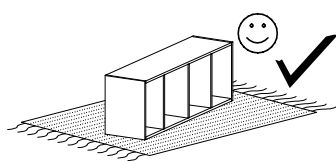
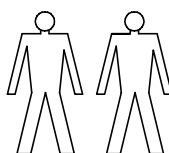
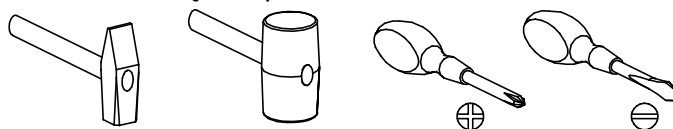

UWAGA !!!

MONTOWANIE USZKODZONYCH
ELEMENTÓW POWODUJE UTRATĘ
GWARANCJI

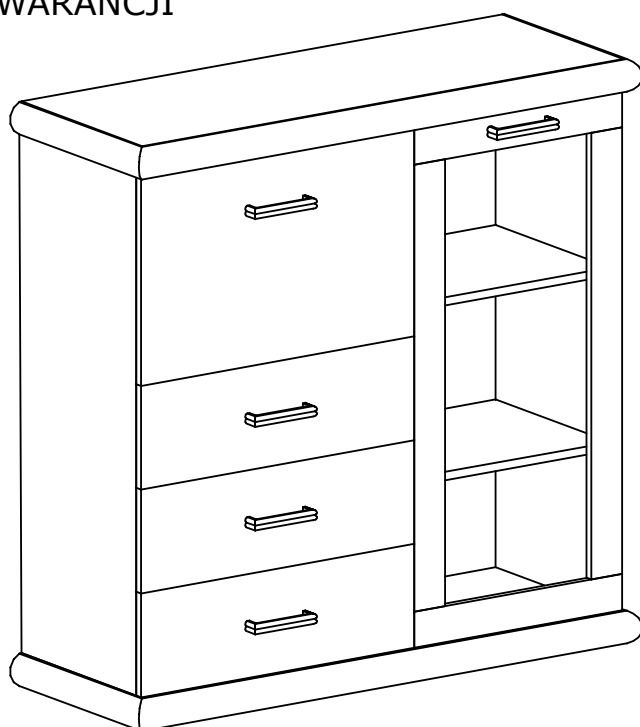

| Nr | D[mm] | S[mm] | G[mm] | Ilość |
|----|-------|-------|-------|-------|
| 1 | 1155 | 450 | 65 | 1 |
| 2 | 1155 | 450 | 65 | 1 |
| 3 | 1020 | 410 | 16 | 1 |
| 4 | 1020 | 410 | 16 | 1 |
| 5 | 1020 | 410 | 16 | 1 |
| 6 | 635 | 380 | 16 | 1 |
| 7 | 1045 | 450 | 2,5 | 1 |
| 8 | 1045 | 636 | 2,5 | 1 |
| 9 | 432 | 380 | 16 | 2 |
| 10 | 961 | 450 | 16 | 1 |
| 11 | 590 | 355 | 2,5 | 3 |
| 12 | 635 | 190 | 16 | 3 |
| 13 | 350 | 150 | 16 | 3 |
| 14 | 350 | 150 | 16 | 3 |
| 15 | 560 | 150 | 16 | 3 |
| 16 | 617 | 410 | 16 | 1 |

UWAGA !!!

Mebel zawiera
elementy drewniane

W przypadku reklamacji proszę podać numer pakowacza znajdujący się na kartonie.

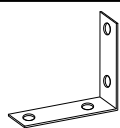

I - 2 St.

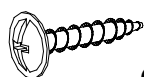

Q - 4 St.
3,5x16 mm



Y - 8 St.



X1 - 6 St.



W - 1 St.

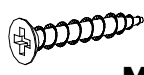

M - 50 St.
3x30 mm

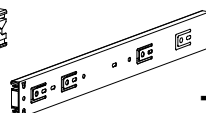
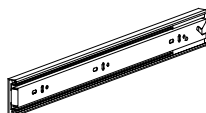

T - 3 Kpl.

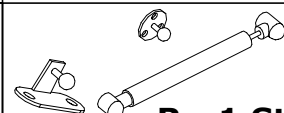

R - 1 St.



J - 24 St.
5x13 mm

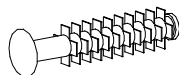

P - 12 St.



A1 - 4 St.
7x50 mm

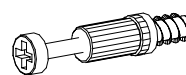

K - 18 St.



L - 18 St.

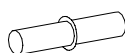

S - 8 St.

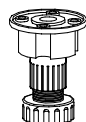

F - 5 St.



U - 5 St.

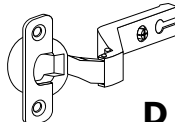

D - 4 St.

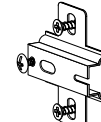

C - 4 St.



E - 70 St.



B - 24 St.



G - 36 St.
3,5x16 mm



Z - 1 St.



N - 10 St.
4x27 mm

I

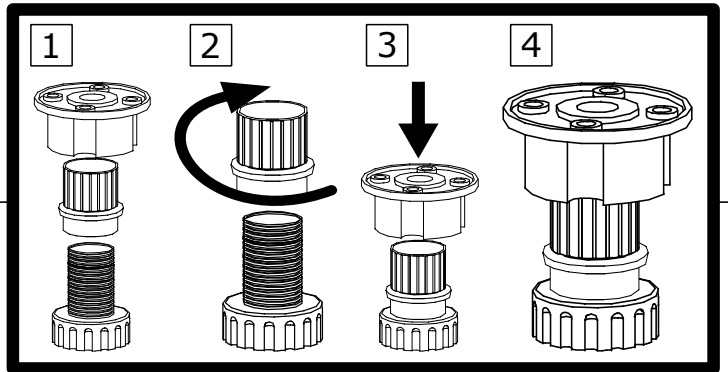
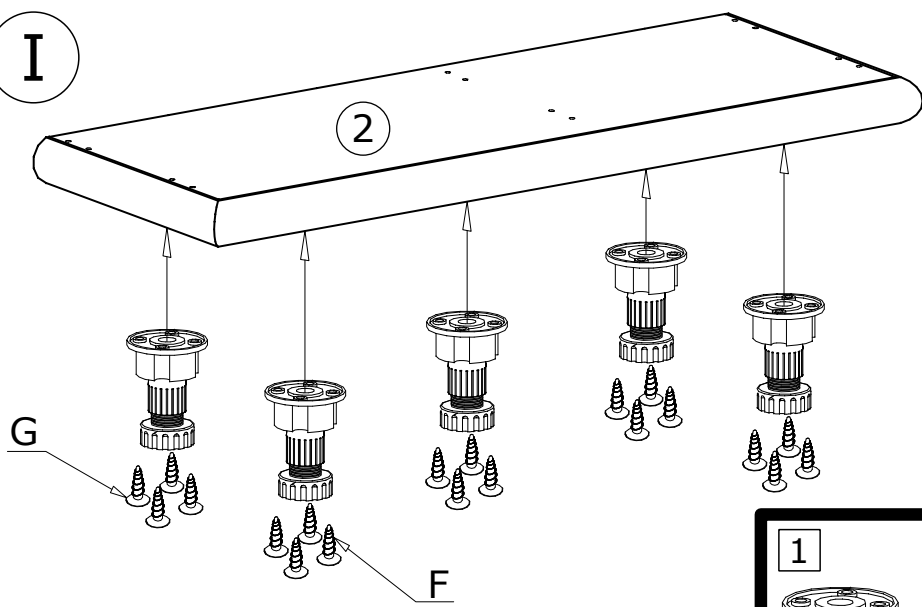

II

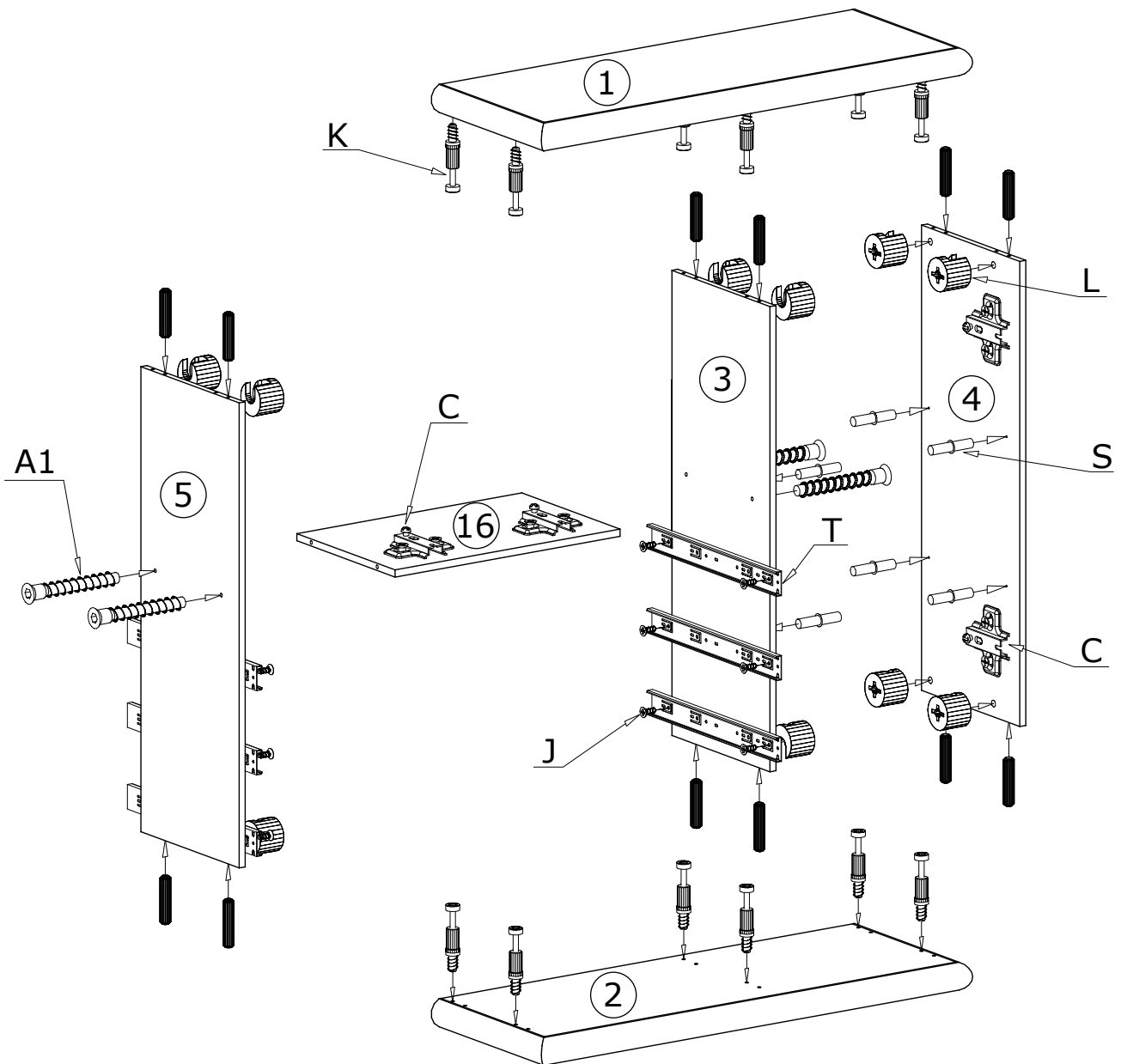

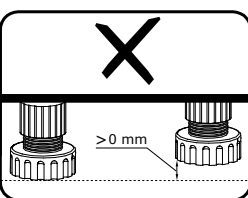
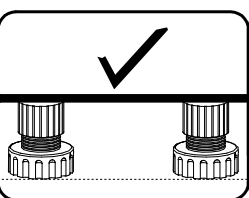
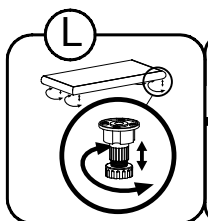
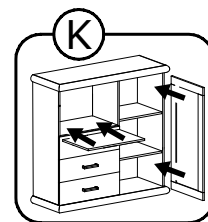
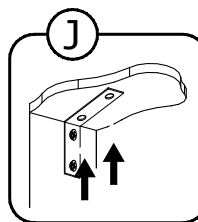
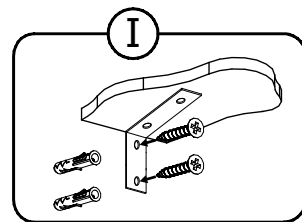
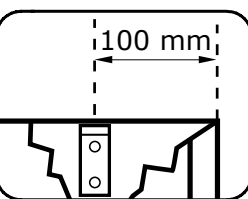
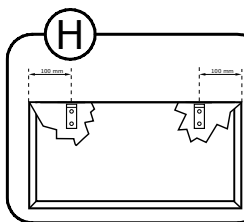
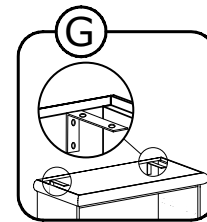
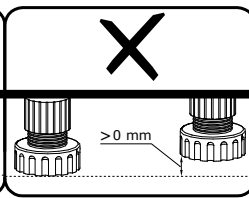
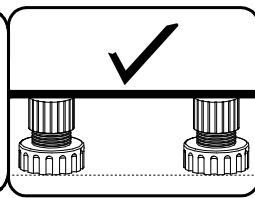
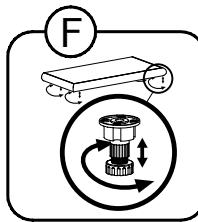
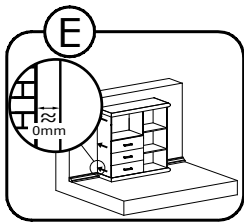
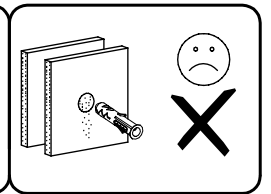
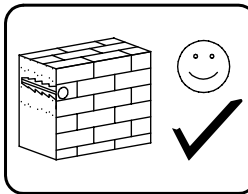
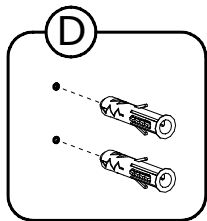
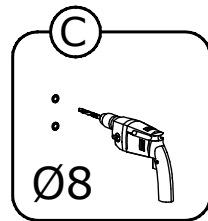
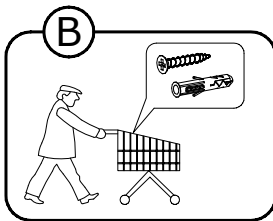
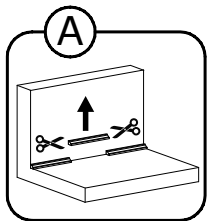
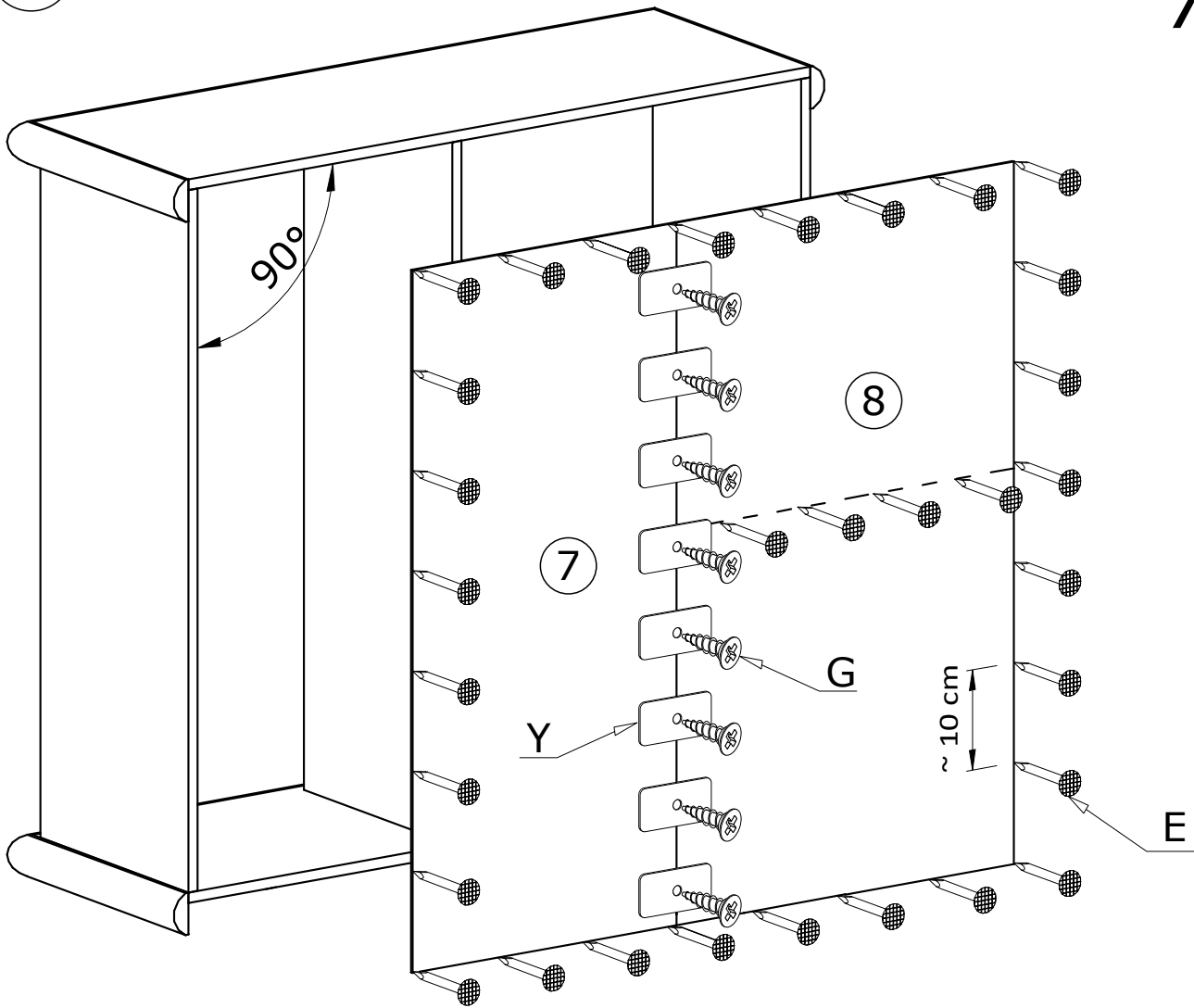

IV

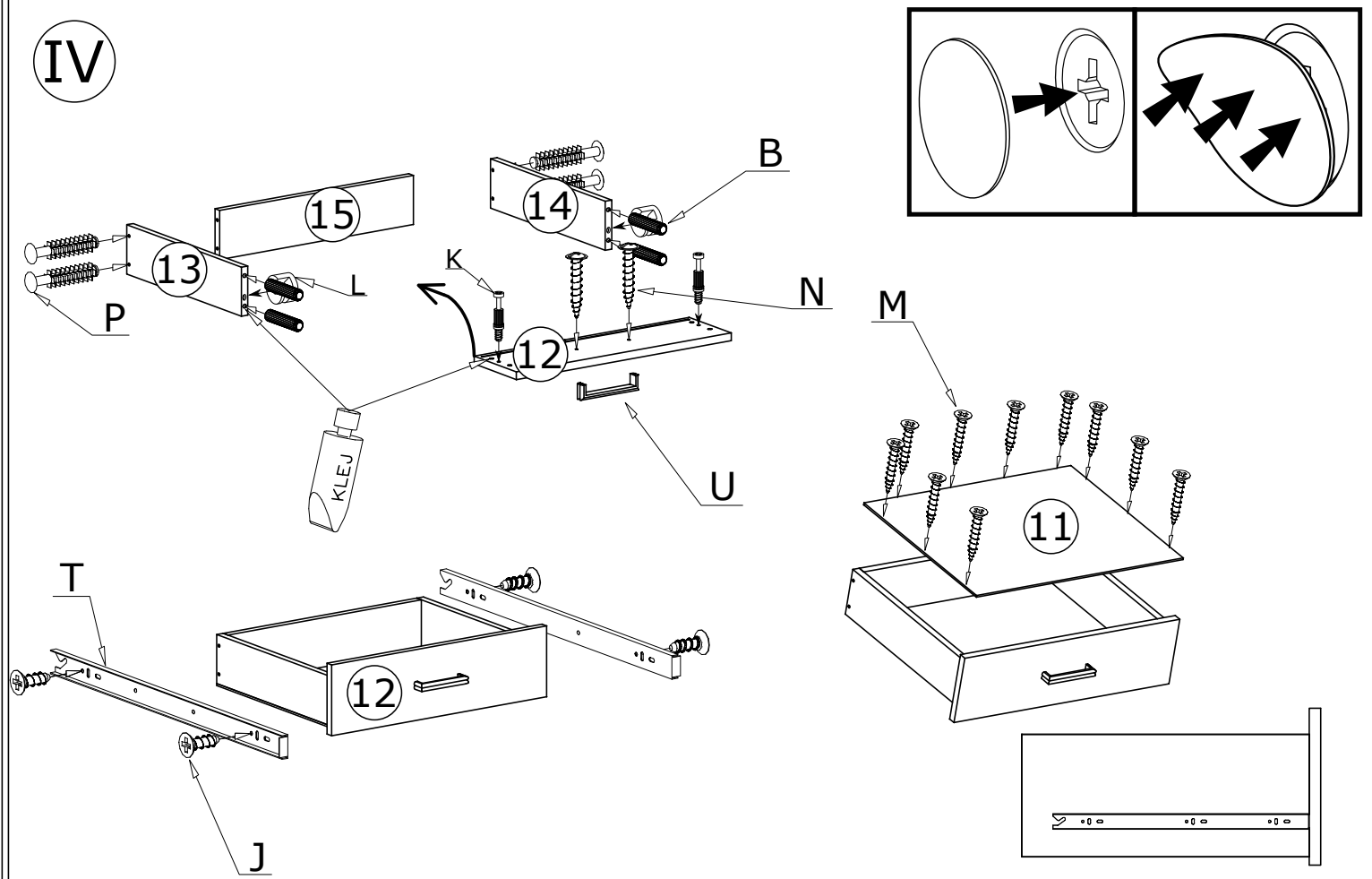

V

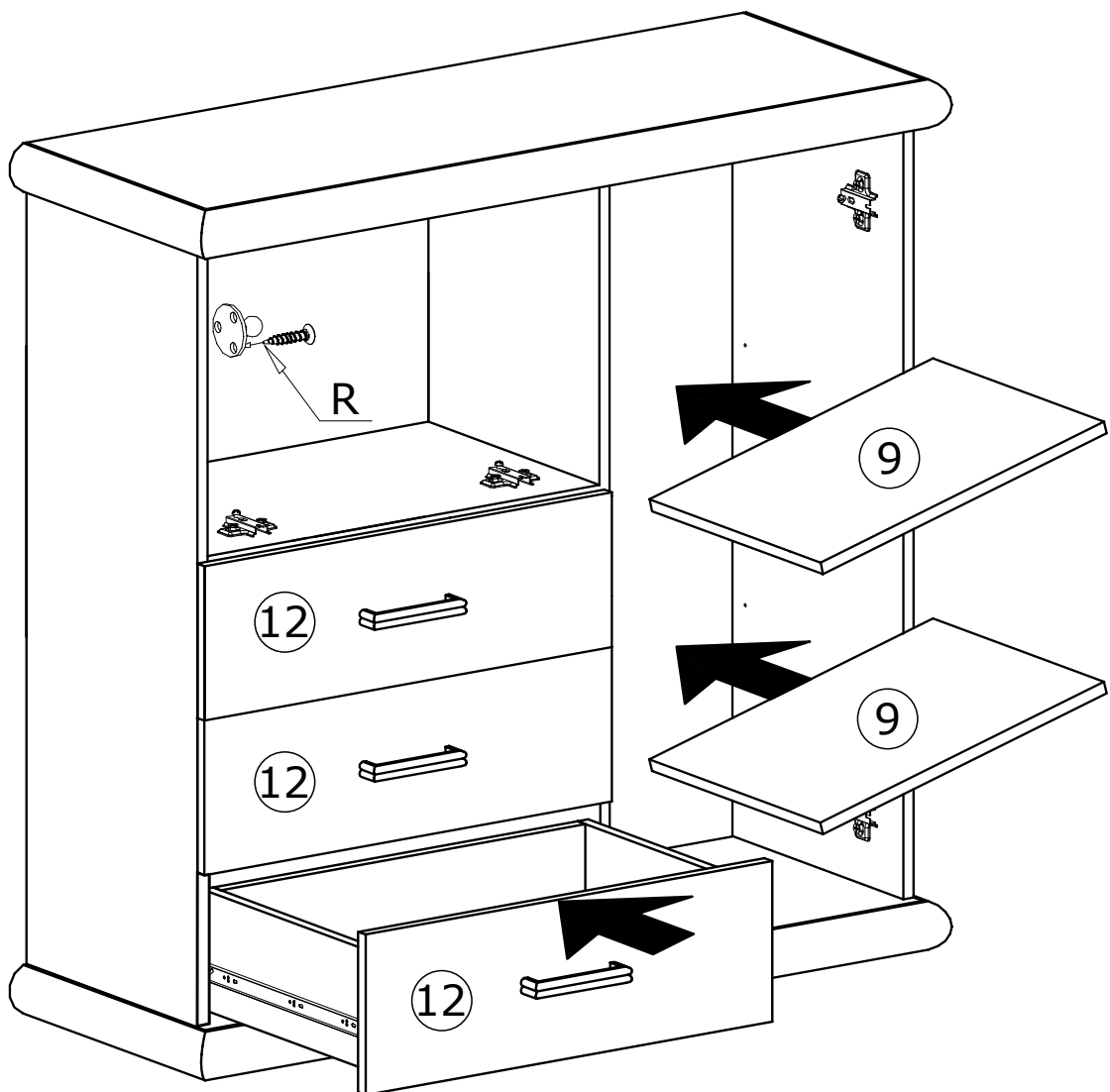

MONTAŻ/DEMONTAŻ PROWADNIC

1

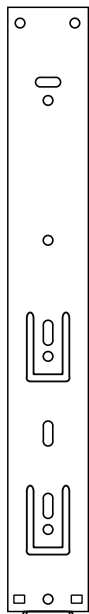

2

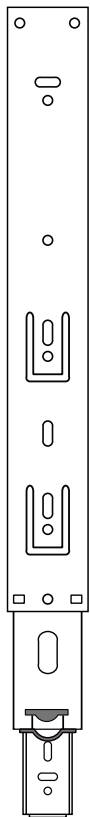

3

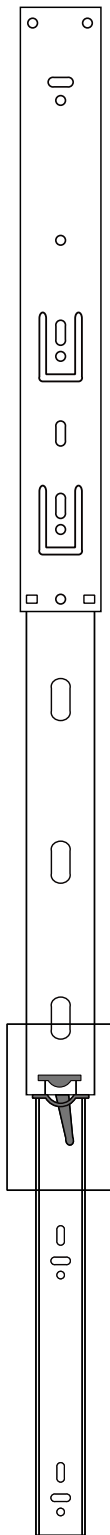

4

