

DALLAS 7

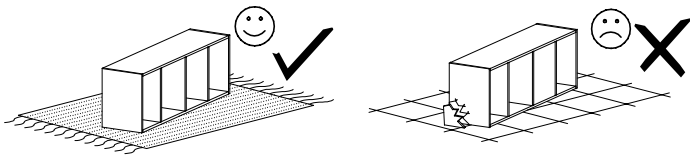

Narzędzia potrzebne do montażu

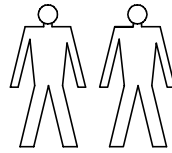
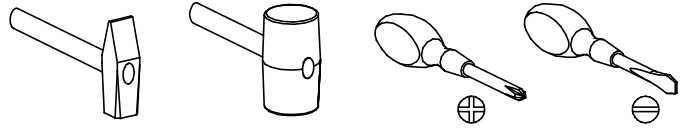

UWAGA !!!

MONTOWANIE USZKODZONYCH
ELEMENTÓW POWODUJE UTRATĘ
GWARANCJI

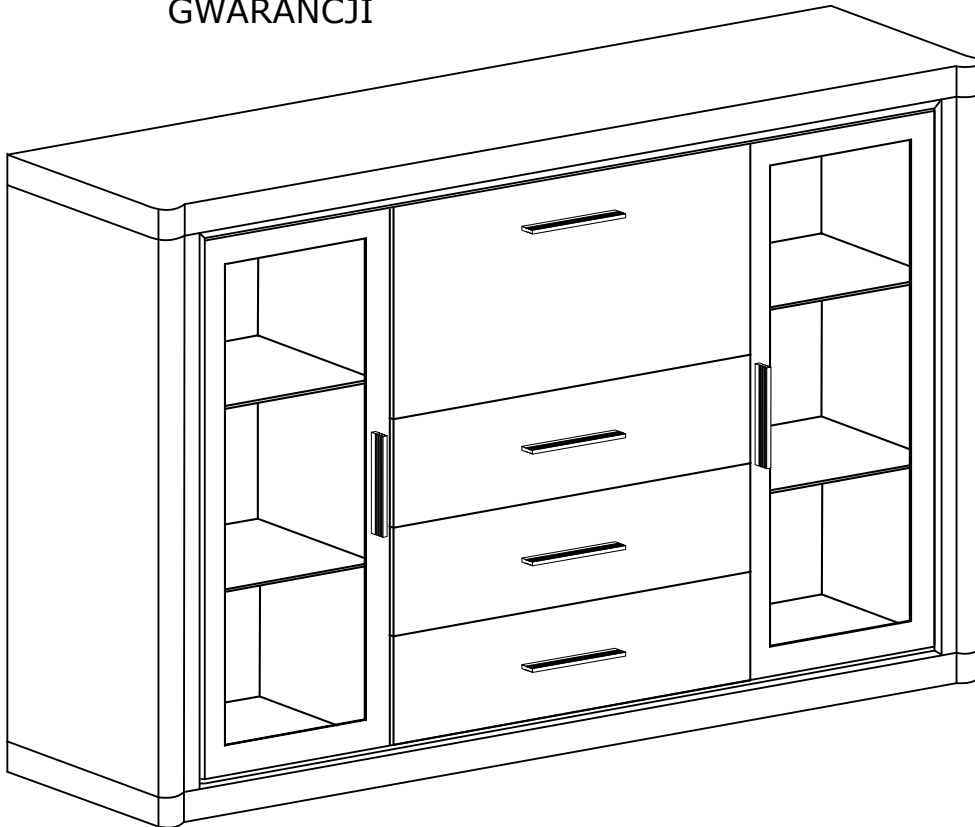

| Nr | D[mm] | S[mm] | G[mm] | Ilość |
|----|-------|-------|-------|-------|
| 1 | 1570 | 450 | 48 | 1 |
| 2 | 1570 | 450 | 48 | 1 |
| 3 | 1530 | 25 | 16 | 2 |
| 4 | 995 | 422 | 16 | 1 |
| 5 | 995 | 422 | 16 | 1 |
| 6 | 995 | 100 | 32 | 1 |
| 7 | 995 | 100 | 32 | 1 |
| 8 | 1026 | 405 | 16 | 1 |
| 9 | 1026 | 405 | 16 | 1 |
| 10 | 438 | 380 | 4 | 4 |
| 11 | 636 | 386 | 16 | 1 |
| 12 | 636 | 190 | 16 | 3 |
| 13 | 400 | 150 | 16 | 3 |
| 14 | 400 | 150 | 16 | 3 |
| 15 | 560 | 150 | 16 | 3 |
| 16 | 590 | 405 | 2,5 | 3 |
| 17 | 1050 | 462 | 2,5 | 2 |
| 18 | 1050 | 634 | 2,5 | 1 |
| 19 | 618 | 405 | 16 | 1 |
| 20 | 966 | 365 | 16 | 2 |

W przypadku reklamacji proszę podać numer pakowacza znajdujący się na kartonie.

| | | | | |
|------------------------------------|------------------------------------|----------------------------------|-----------------------|----------------------------------|
| V1 - 2 St. | W - 4 St. | Y - 12 St. | I - 2 St. | X1 - 12 St. |
| V2 - 4 St. 3,5x16 mm | A - 6 St. | M - 24 St. 4x25 mm | T - 3 Kpl. | Q - 1 Kpl. |
| P - 16 St. | N - 12 St. 4x30 mm | C - 6 St. | L - 28 St. | |
| U - 6 St. | G - 24 St. 3,5x16 mm | D - 4 St. | F - 12 St. | S - 1 St. |
| E - 110 St. | B - 28 St. | K - 28 St. | Z - 1 St. | J - 12 St. 5x13 mm |

I

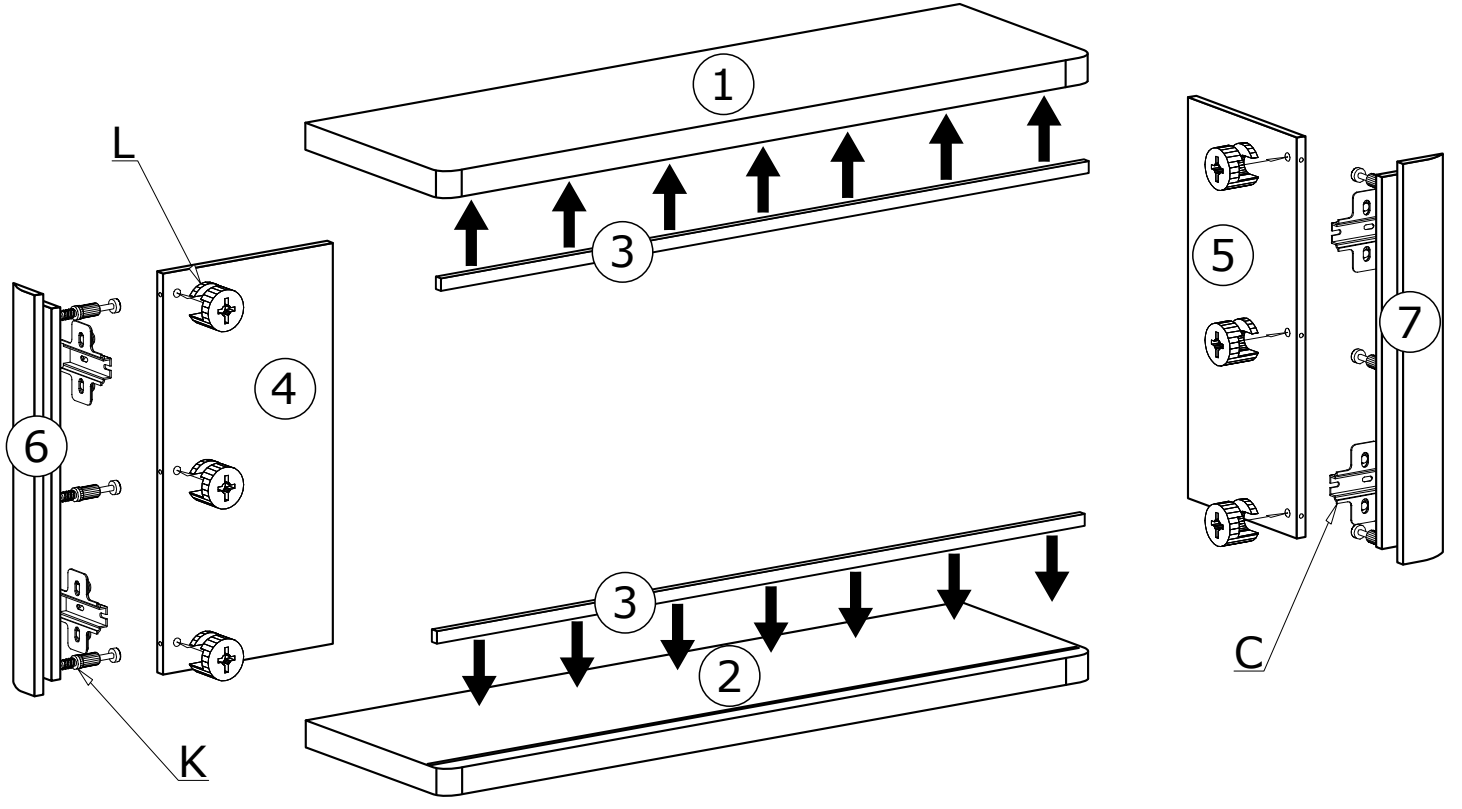

II

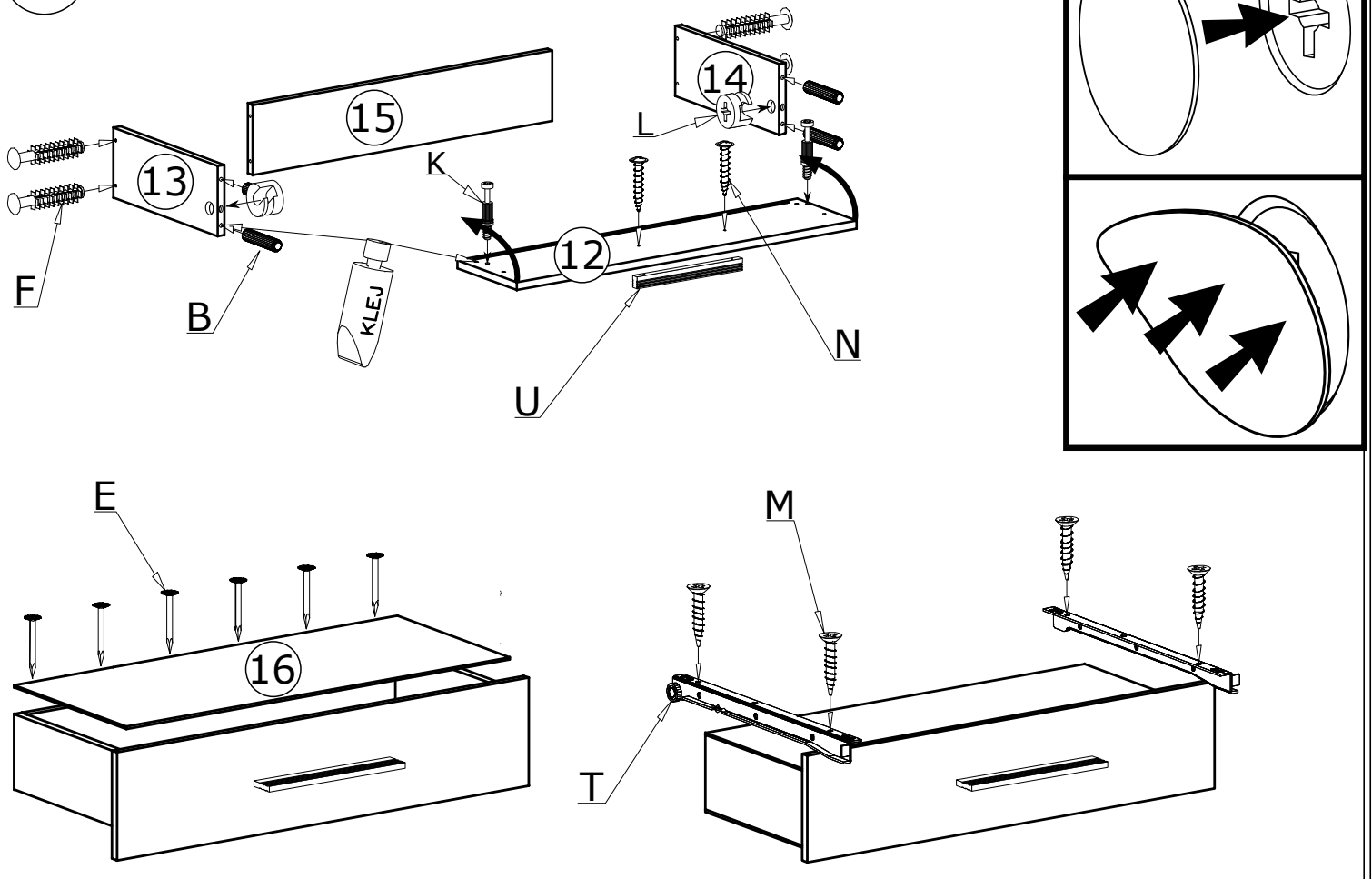

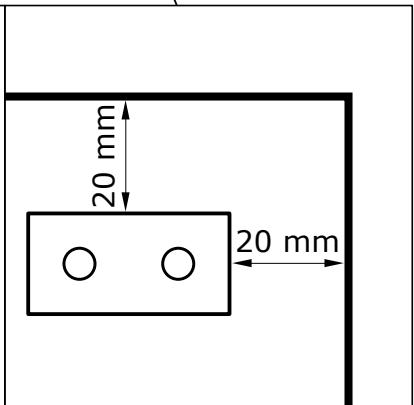
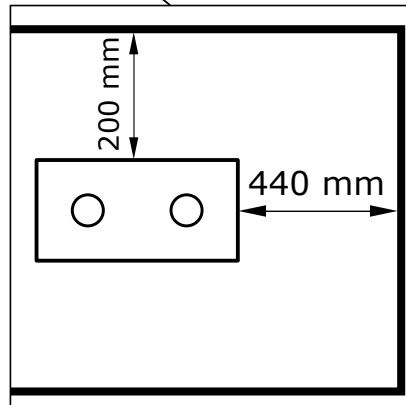
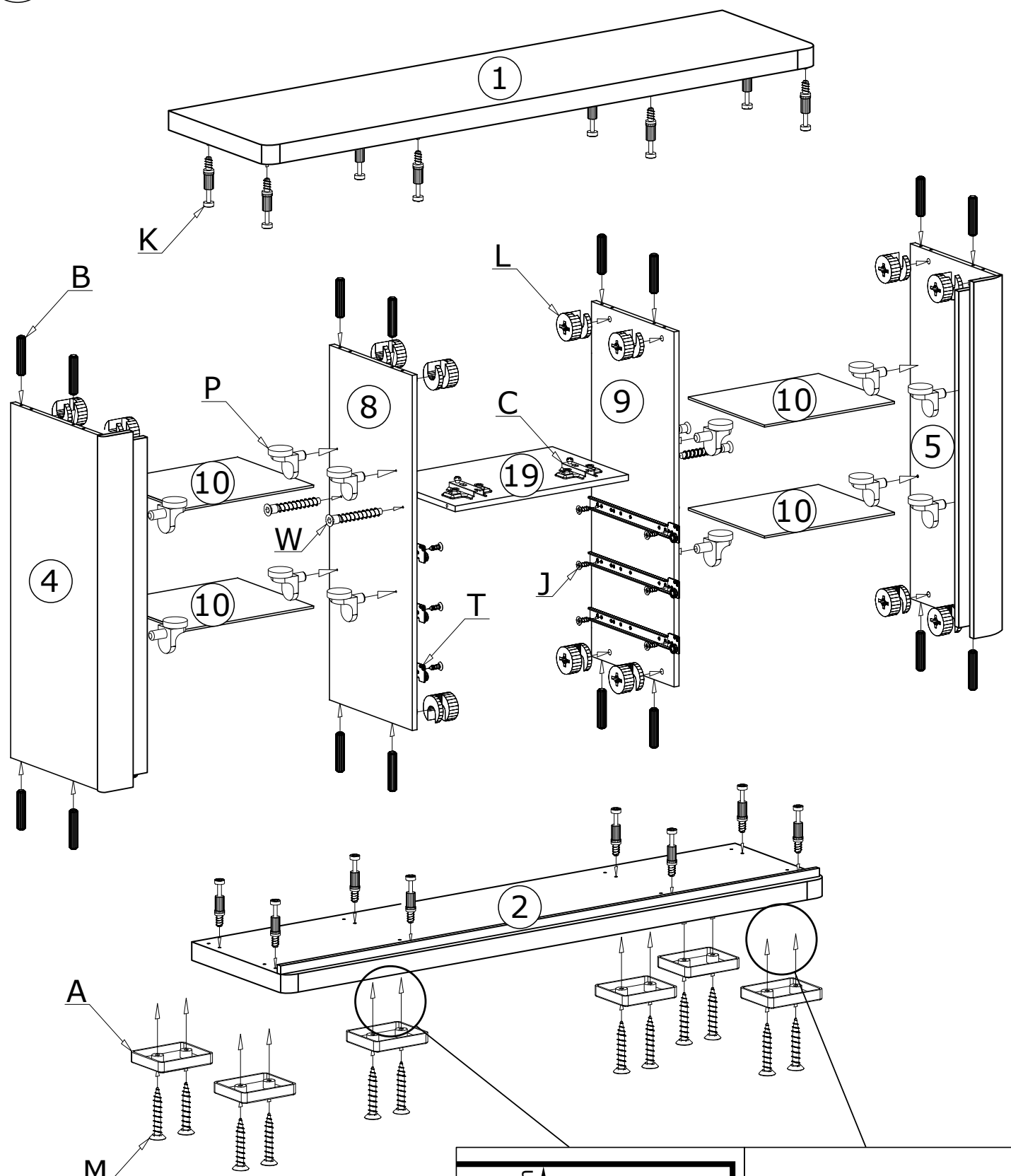

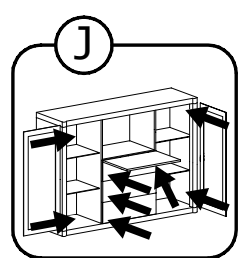
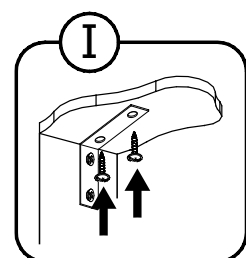
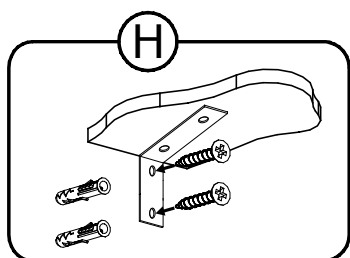
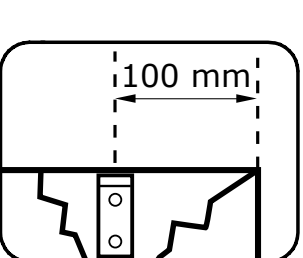
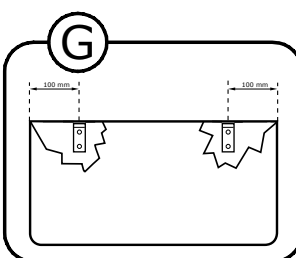
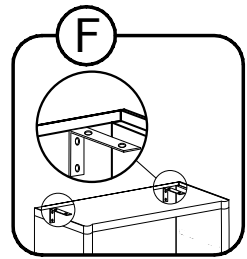
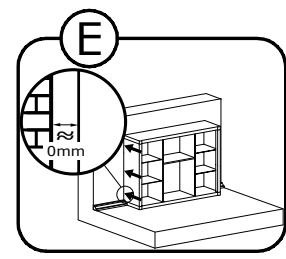
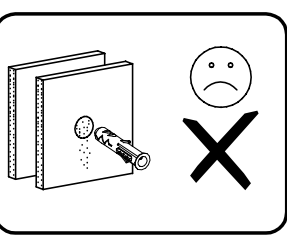
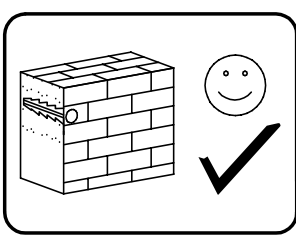
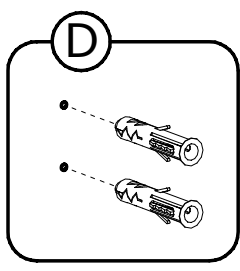
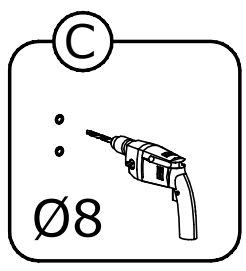
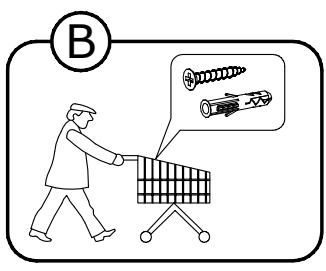
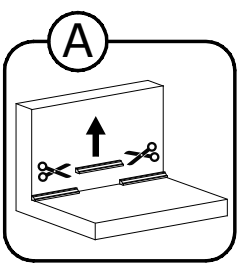
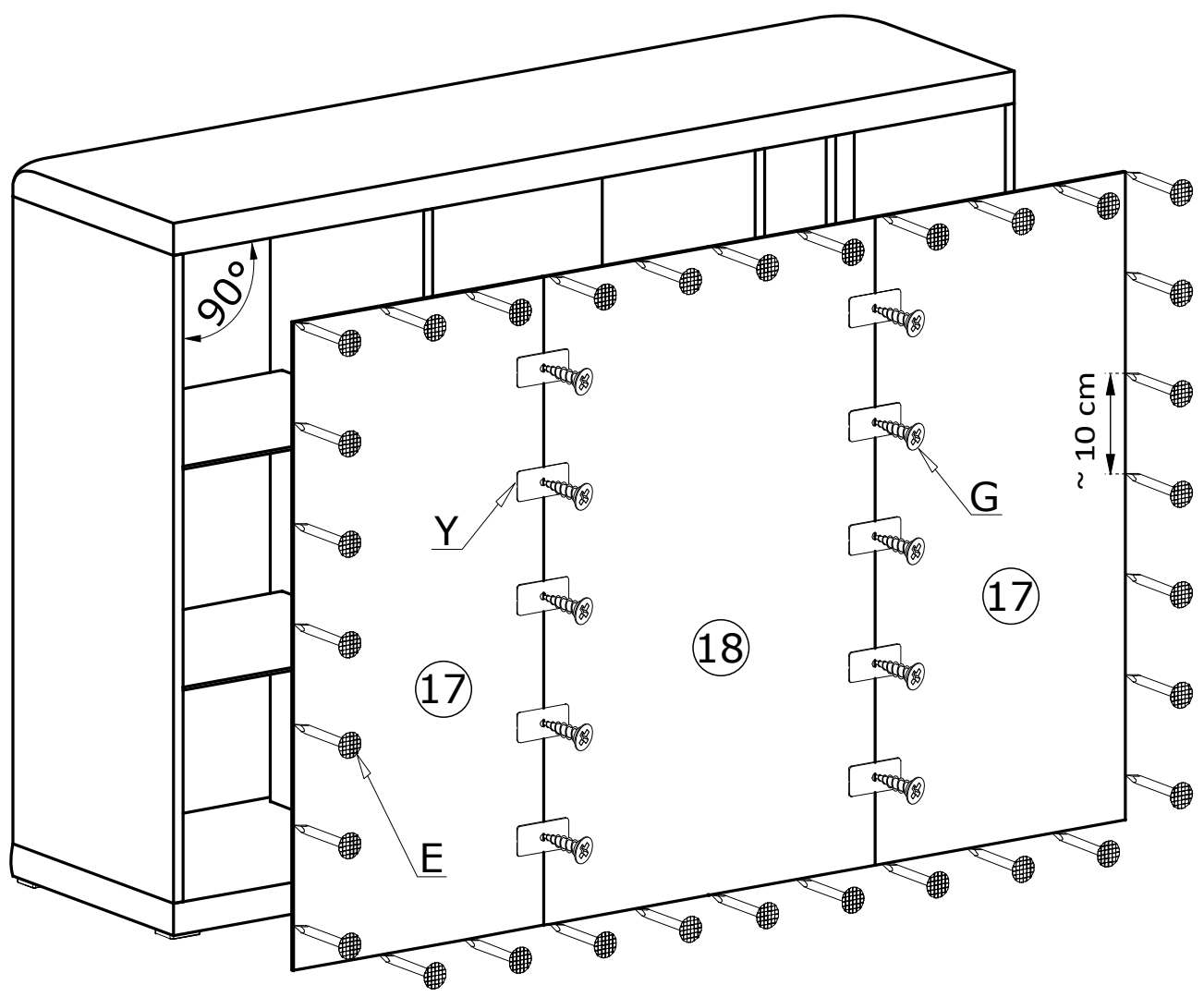

V

