

DALLAS 6

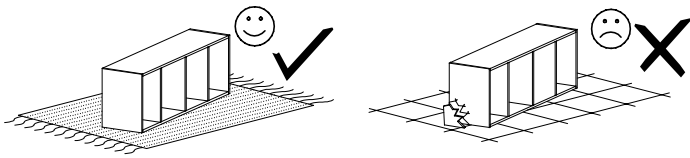

Narzędzia potrzebne do montażu

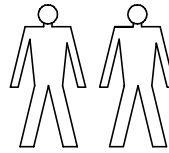
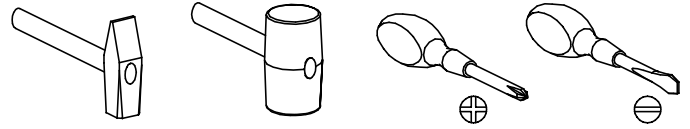

UWAGA !!!

MONTOWANIE USZKODZONYCH
ELEMENTÓW POWODUJE UTRATĘ
GWARANCJI

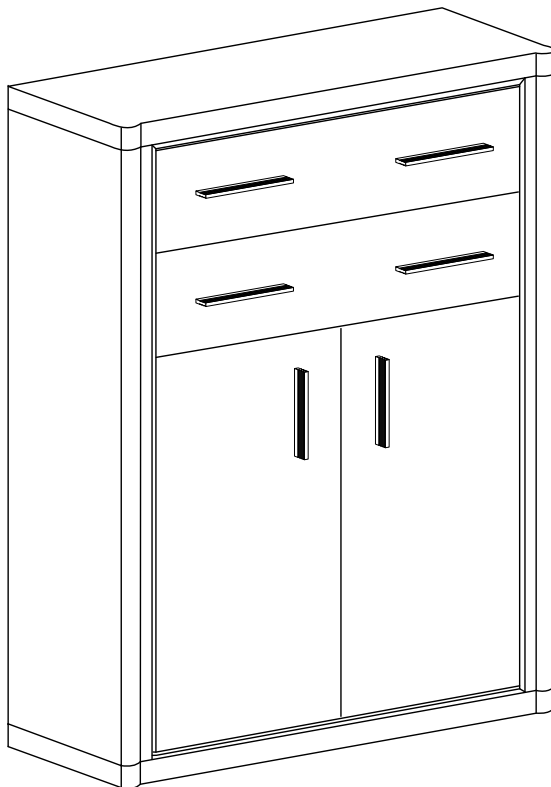

Nr	D[mm]	S[mm]	G[mm]	Ilość
1	970	450	48	1
2	970	450	48	1
3	930	25	16	2
4	1120	420	16	1
5	1120	420	16	1
6	1120	100	32	1
7	1120	100	32	1
8	395	405	16	1
9	395	405	16	1
10	935	405	16	1
11	935	380	16	1
12	1176	960	2,5	1
13	400	150	16	2
14	400	150	16	2
15	695	150	16	2
16	770	190	16	2
17	723	405	2,5	2
18	700	384	16	1
19	700	384	16	1

W przypadku reklamacji proszę podać numer pakowacza znajdujący się na kartonie.

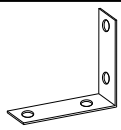

Y - 2 St.

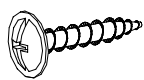

I - 4 St.
3,5x16 mm

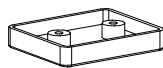

A - 4 St.

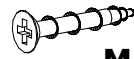

M - 16 St.
4x25 mm

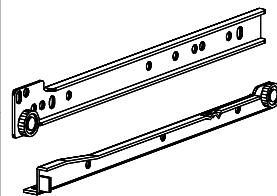

T - 2 Kpl.

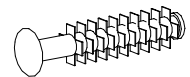

F - 8 St.

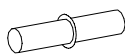

P - 4 St.



N - 12 St.
4x30 mm

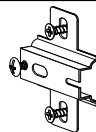

C - 4 St.



L - 14 St.

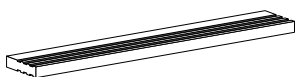

U - 6 St.



G - 8 St.
3,5x16 mm

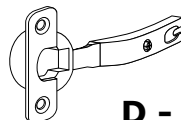

D - 4 St.



W - 4 St.



S - 1 St.



E - 60 St.



B - 24 St.

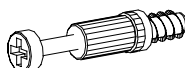

K - 14 St.

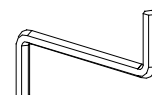

Z - 1 St.



J - 8 St.
5x13 mm

I

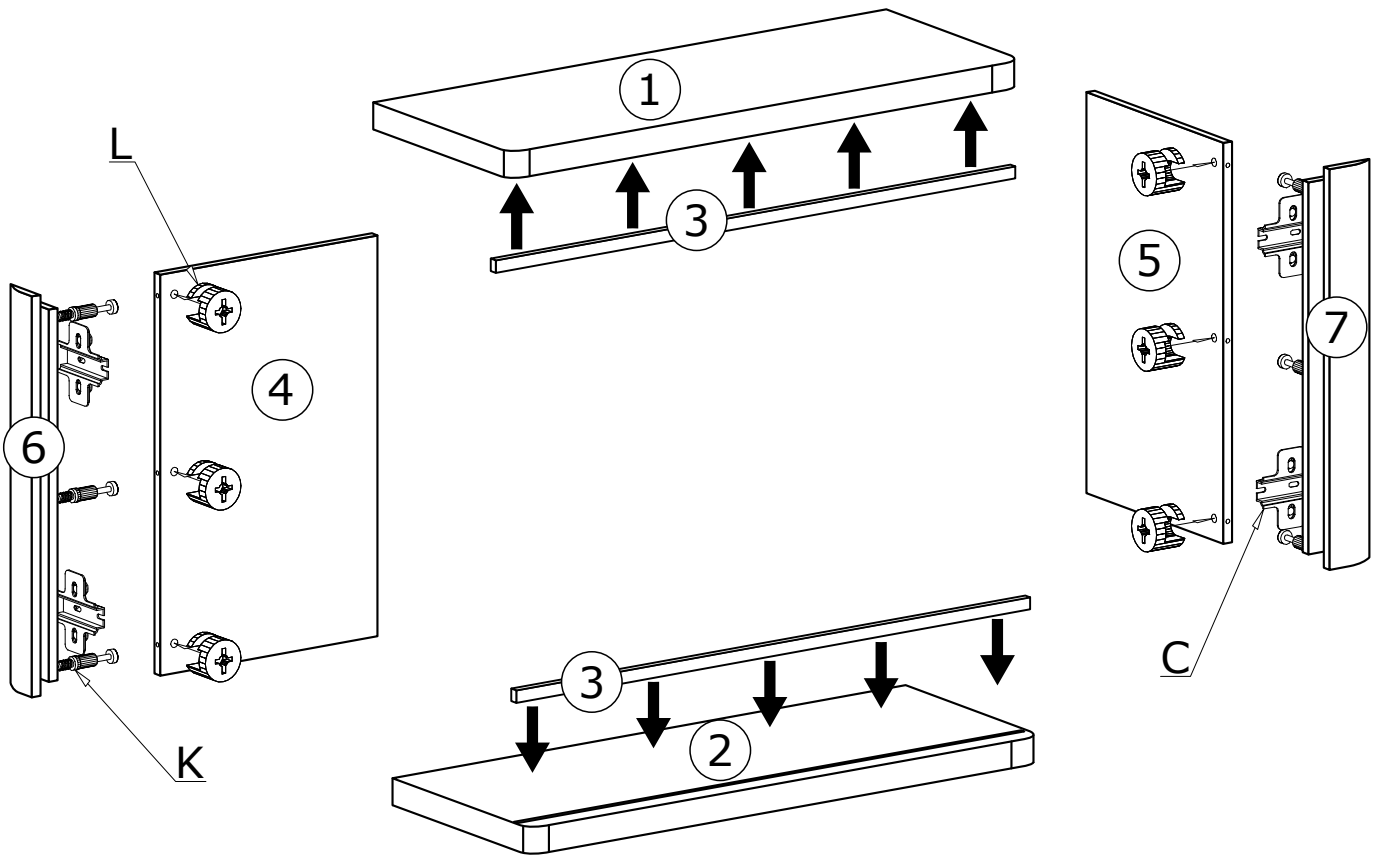

II

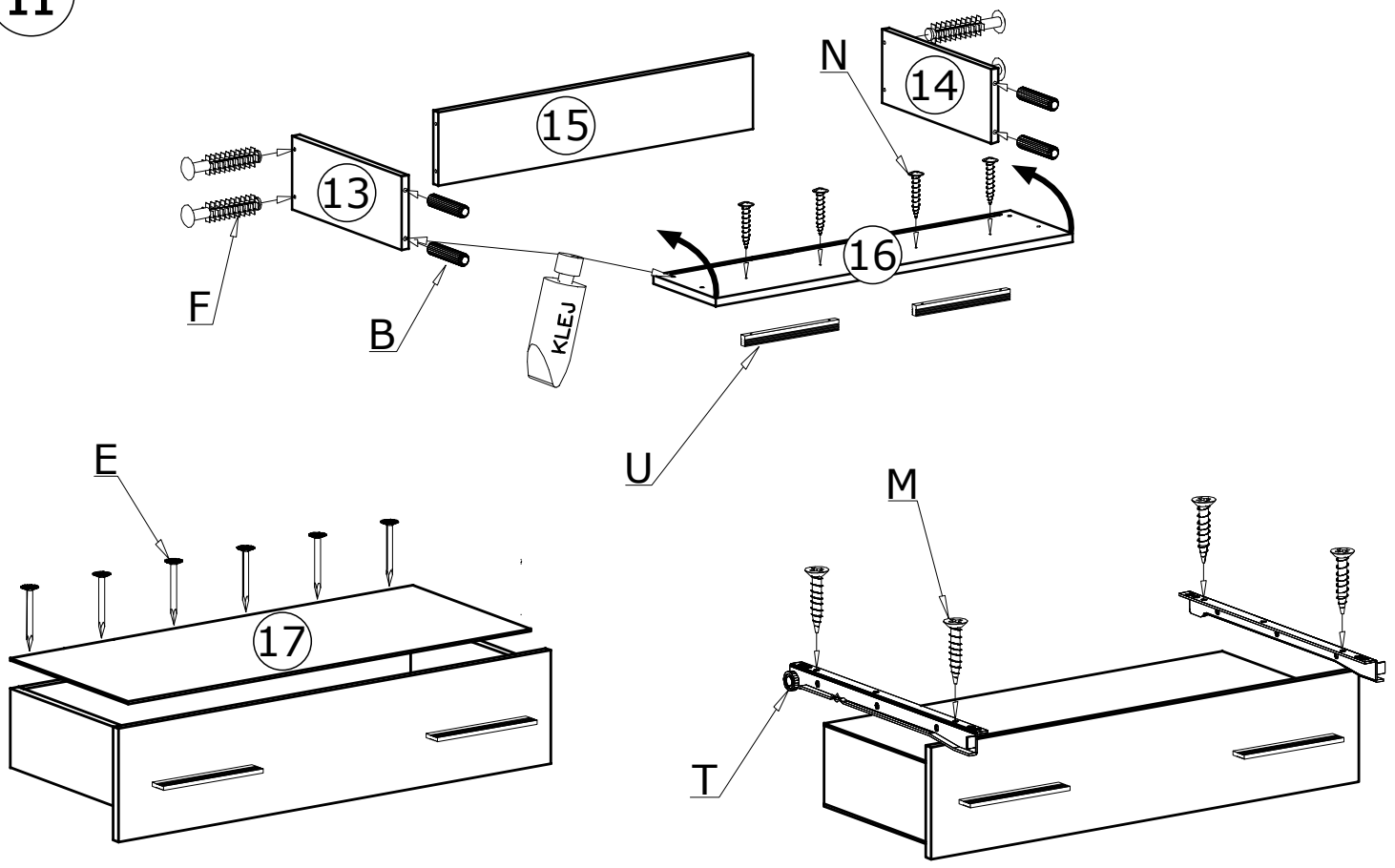

III

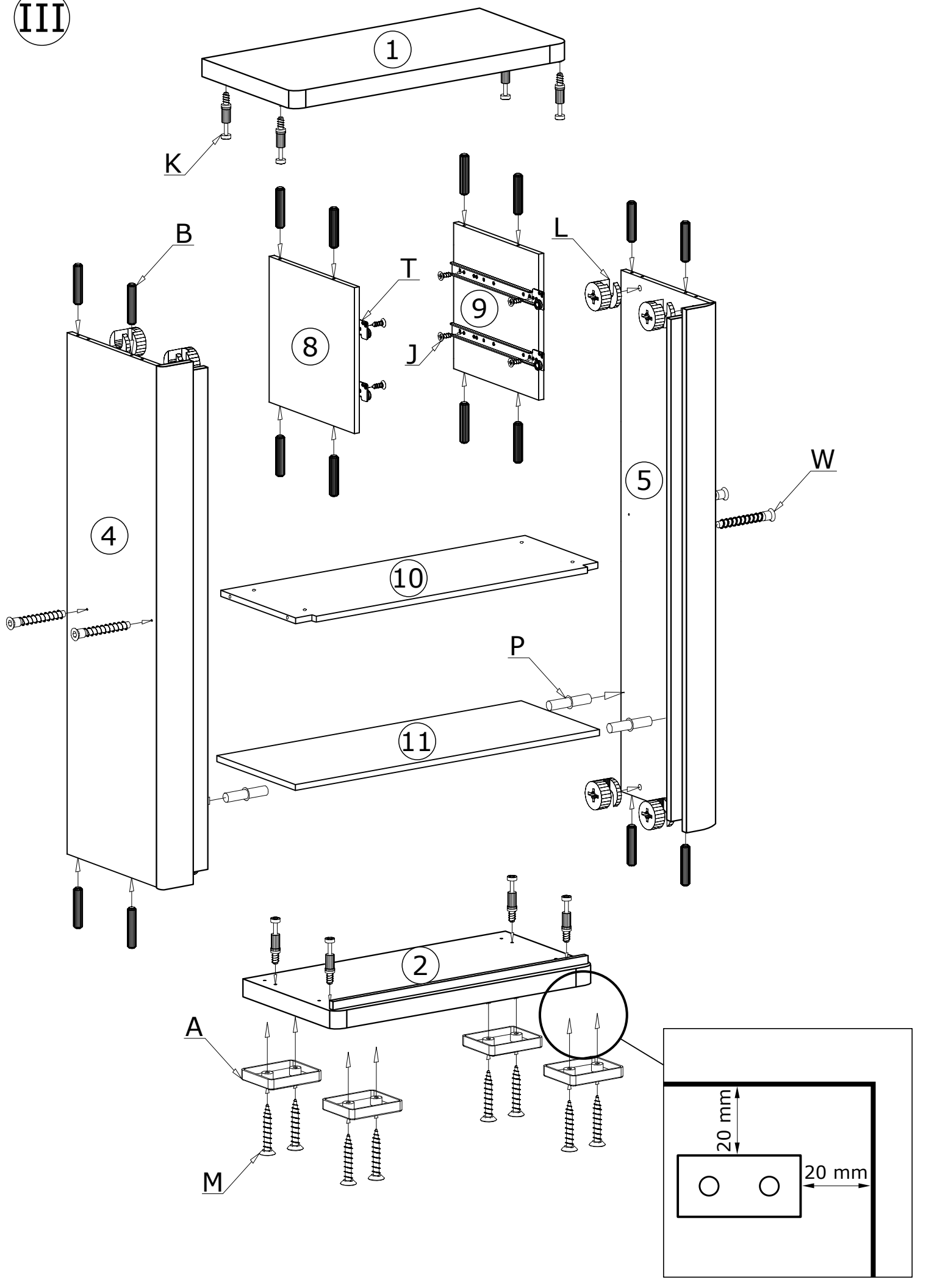

IV

60X 

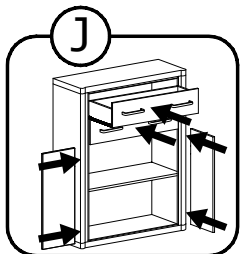
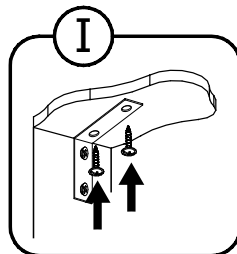
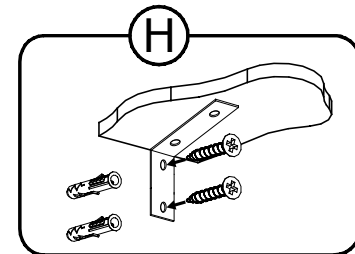
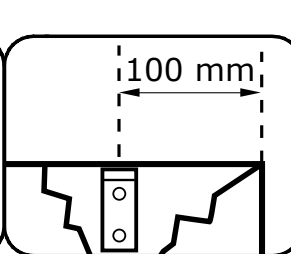
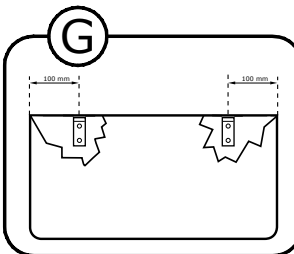
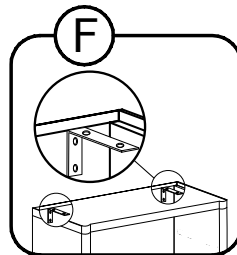
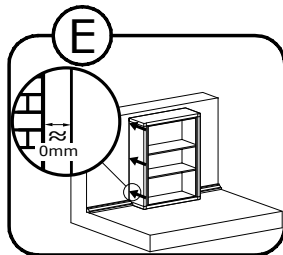
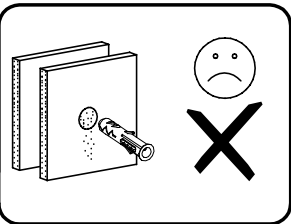
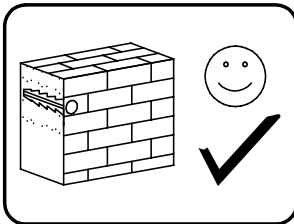
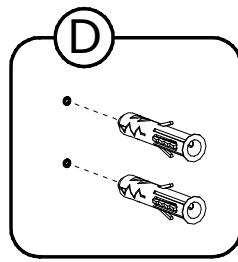
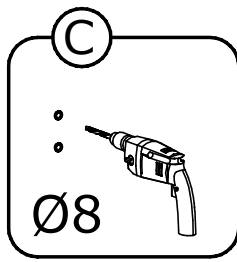
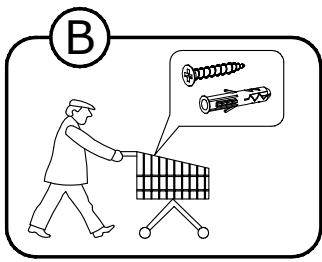
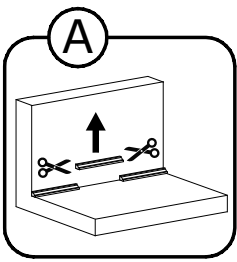
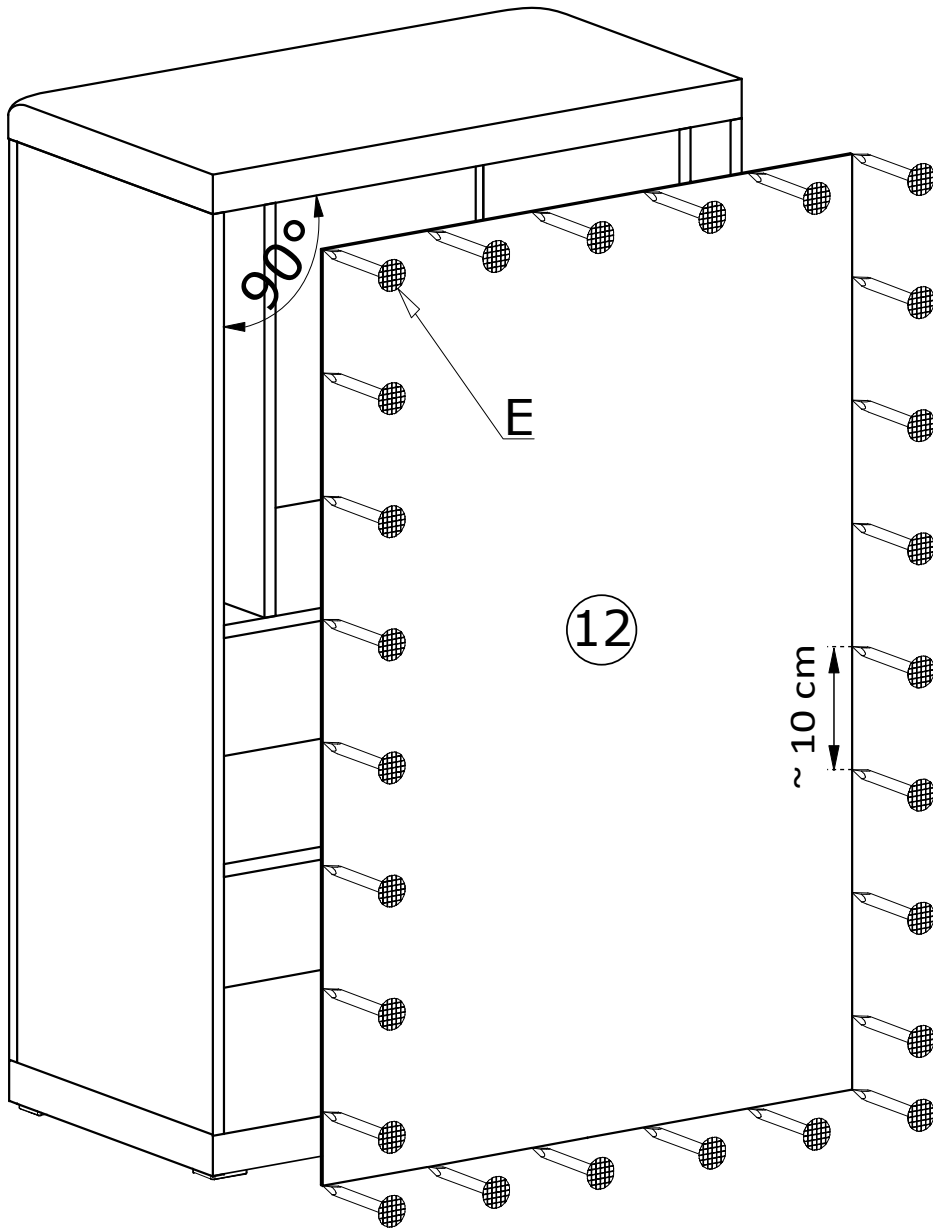

V

