

INDIANAPOLIS 3

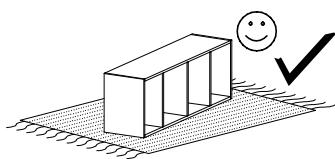

Narzędzia potrzebne do montażu



UWAGA !!!

MONTOWANIE USZKODZONYCH
ELEMENTÓW POWODUJE UTRATĘ
GWARANCJI



Nr	D[mm]	S[mm]	G[mm]	Ilość
1	927	422	16	1
2	1870	403	16	1
3	1870	403	16	1
4	927	403	16	1
5	927	80	16	1
6	927	123	16	1
7	1800	950	2,5	1
8	926	350	4	2
9	1870	80	16	1
10	1870	80	16	1
11	960	422	48	1
12	926	380	16	1
13	782	395	4	2
14	395	120	16	1
15	395	120	16	1
16	395	120	16	1
17	395	120	16	1
18	665	395	16	1
19	665	395	16	1

UWAGA !!!

Mebel zawiera
elementy drewniane

W przypadku reklamacji proszę podać numer pakowacza znajdujący się na kartonie.

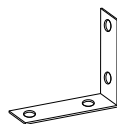

Y - 2 St.

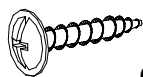

Q - 4 St.
3,5x16 mm

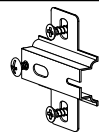

C - 8 St.

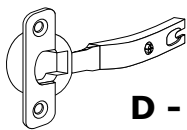

D - 8 St.

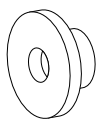

R - 12 St.

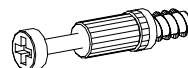

K - 12 St.



P - 4 St.

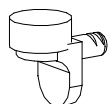

F - 12 St.



S - 6 St.

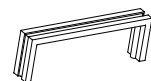

U - 4 St.

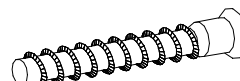

A - 8 St.

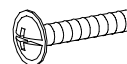

N - 8 St.
4x25 mm



E - 50 St.



B - 24 St.

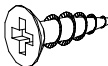

G - 28 St.
3,5x16 mm

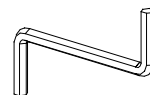

Z - 1 St.



L - 12 St.

I

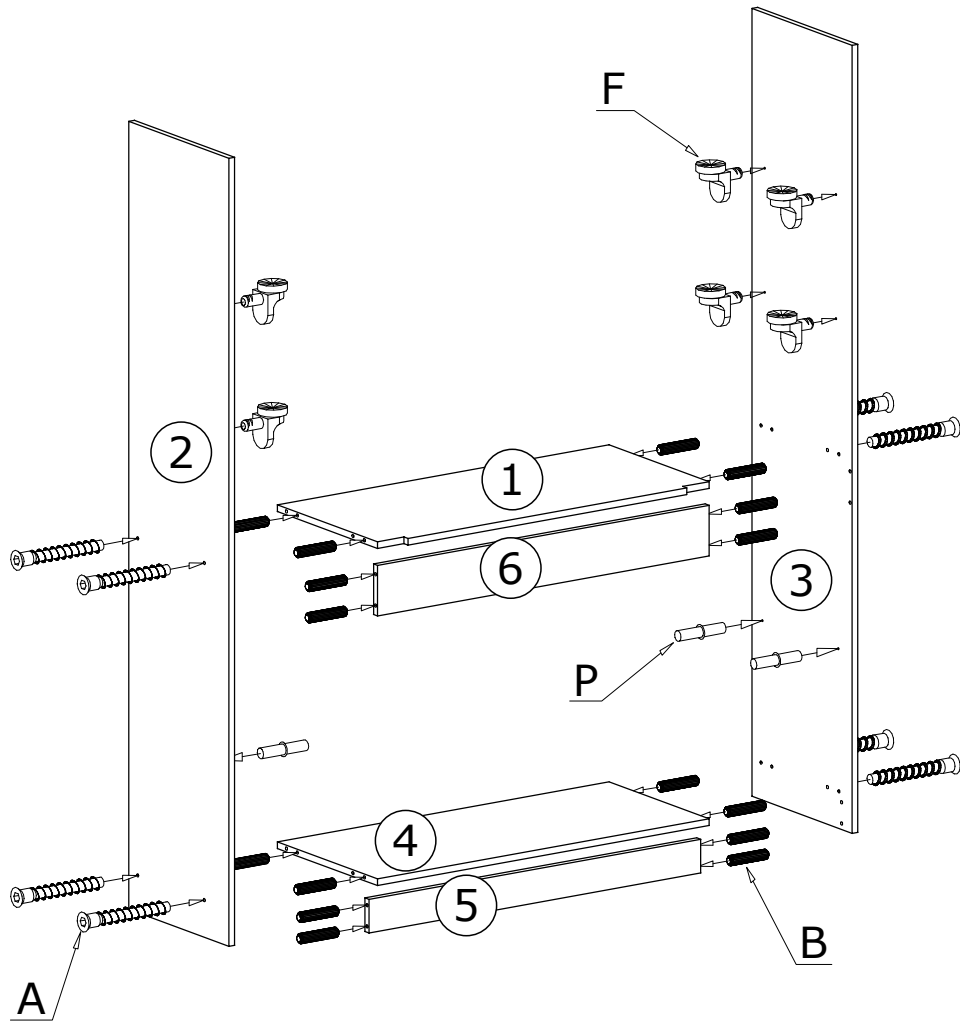

II

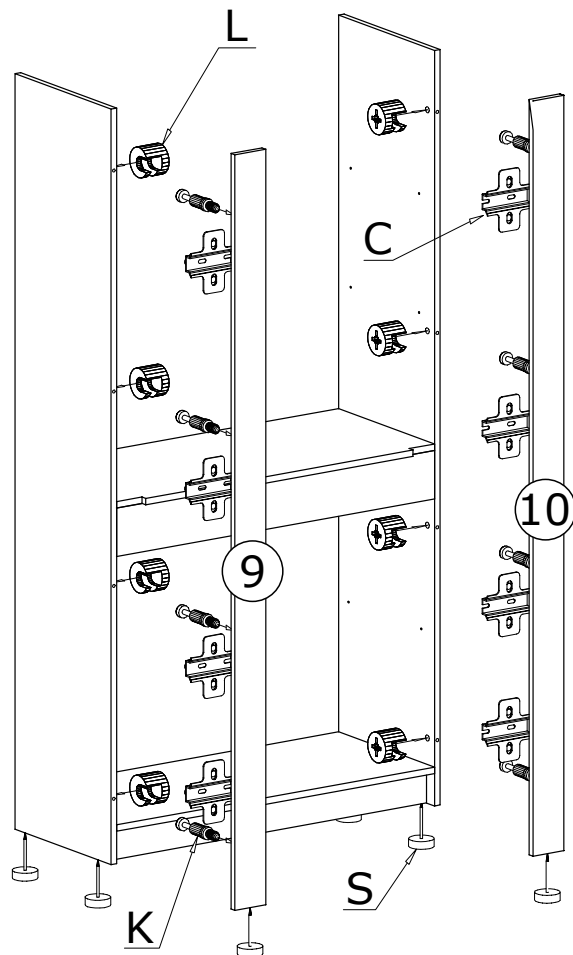

III

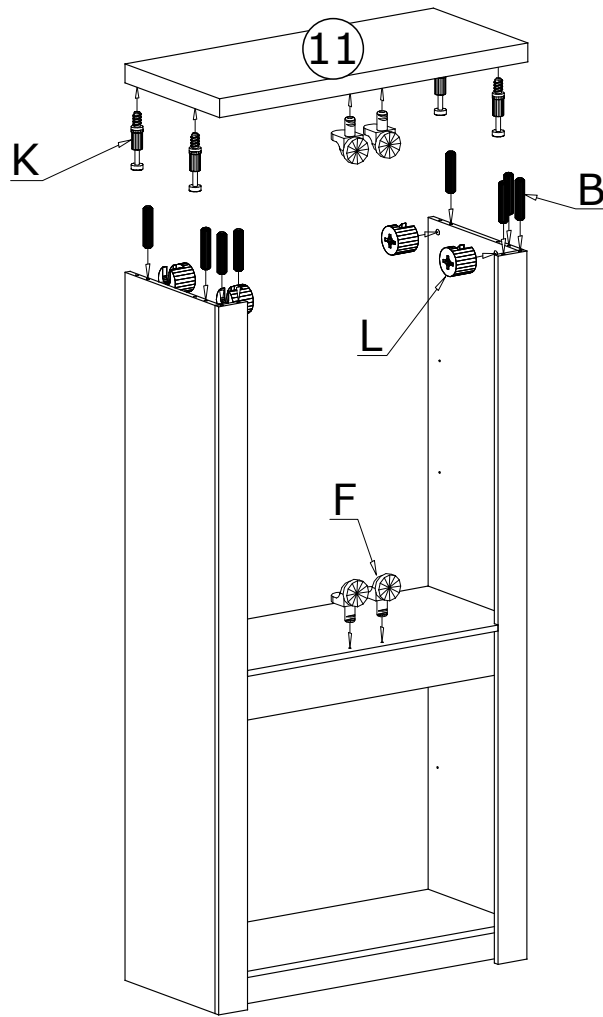

IV

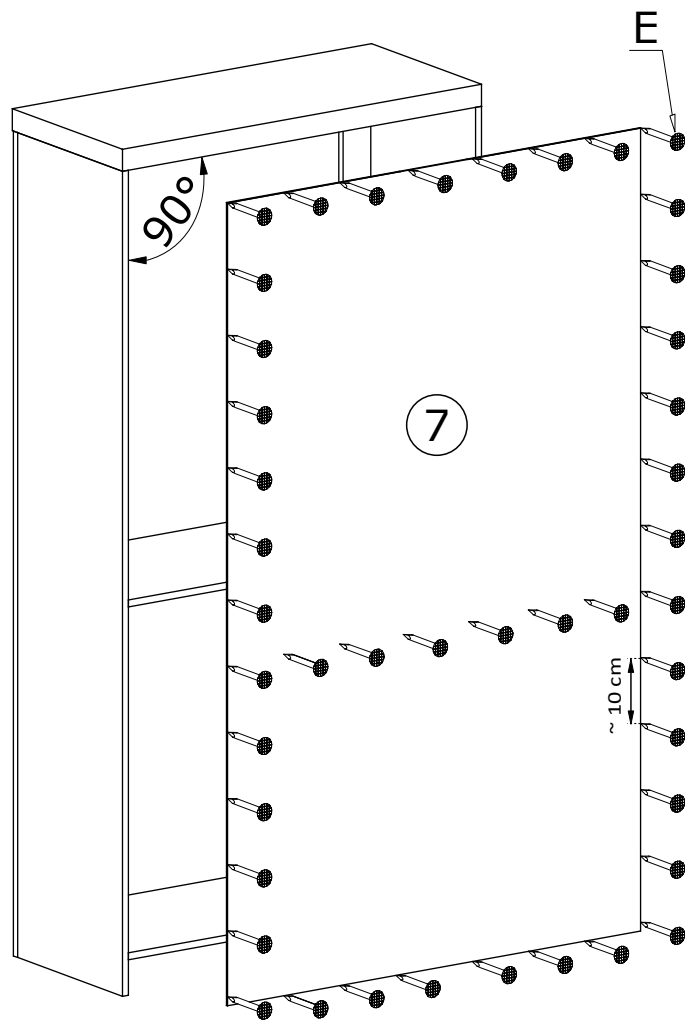

50X 

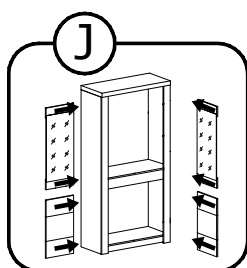
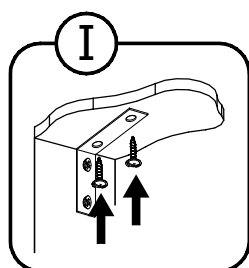
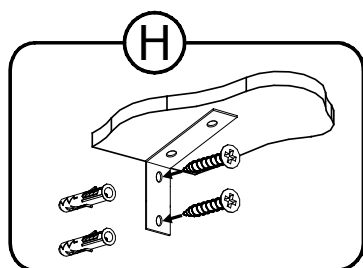
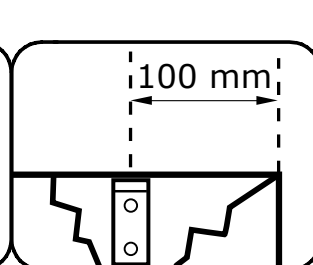
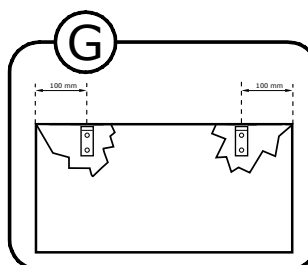
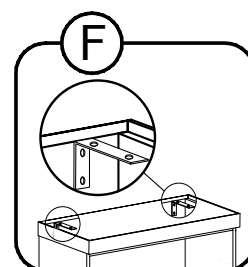
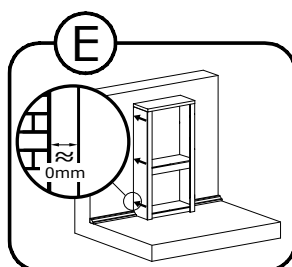
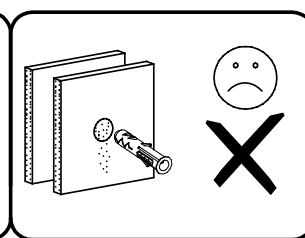
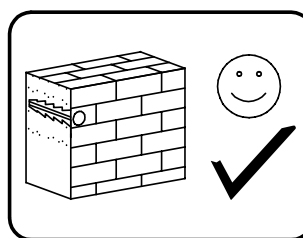
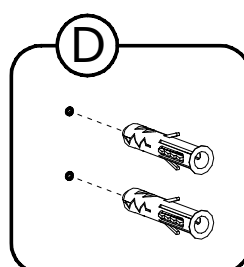
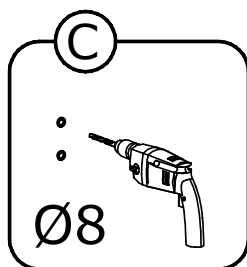
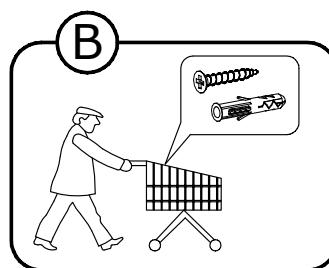
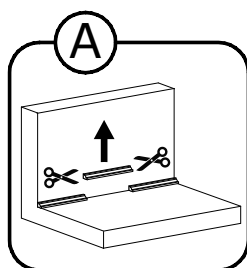
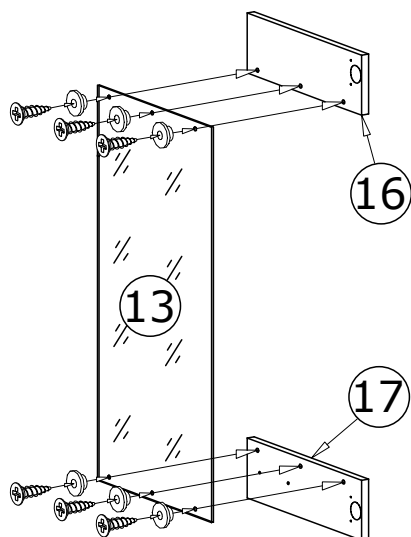
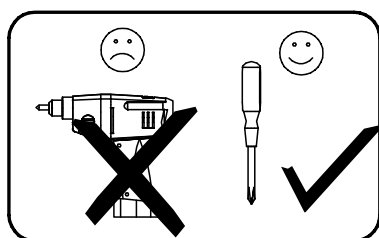
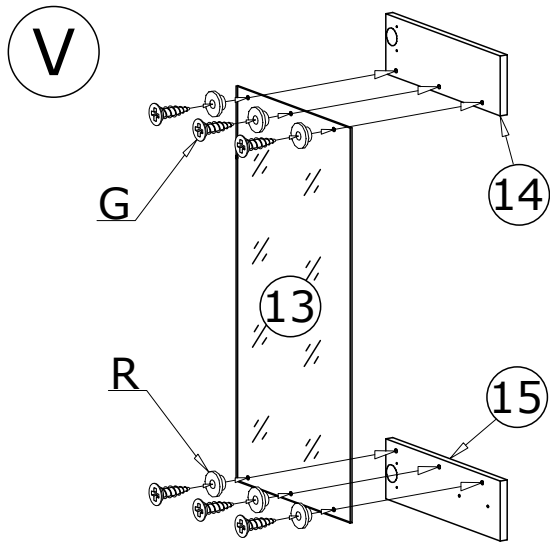

Meble zawierają elementy drewniane, których barwa i układ słoju są uzależnione od wielu czynników, dlatego mogą występować różnice w fakturze i barwie co nie stanowi wady produktu i nie wpływa na jego jakość, trwałość i funkcjonalność.

Listwy drewniane mogą ujawniać niewielkie zmiany w kształcie i wymiarach wywołane specyficznymi warunkami eksploatacji takimi jak: wilgotność, różnice temperatur, etc.

VI

